

Reliability & Versatile Application

SOLENOID VALVES 030 SERIES

This dynamic series uses advanced technology to solve the issue of a lighter and more compact unit with larger flow rate, while at the same time reducing power consumption.

It also offers a variety of options, Rc 1/8 specification, and manifolds for up to 20 units, to provide expandability in response to advanced levels of requirements.

A Full-Choice System in Response to High Performance and Versatility

From the standard specification with emphasis on space savings and cost performance, all the way to the high-spec units for FA use, this advanced solenoid valve series offers a wide range of configurations that build on a base of highly reliable basic functions to incorporate a rich variety of options, made to order products, and additional parts.

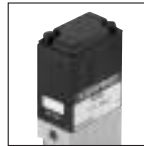

This powerful solenoid, while rated for low current levels (example: 36mA at starting for an AC100V unit), uses a varistor for AC and a flywheel diode for DC as the standard. A reliable surge suppression design.



Achieves a flow rate at this size of 29 ℓ /min [1.02ft.³/min.] (ANR)—at a supply pressure of 0.5MPa [73psi.]. Its ability to cover everything from single units and direct piping to multi-unit manifolds in flexibly expandable and rational configurations is one of its best features.



Plug connectors (optional) offer easy and reliable attaching and removing. Two types are available, straight and L, and both are equipped with LED indicators for easy confirmation of operations.



This solenoid valve includes a built-in interface unit for microcomputer and logic output signal enabling direct control of the solenoid valve. This made to order product is compatible with the FA era.



DIN connectors and 1000mm [39in.] or 3000mm [118in.] lead wires are also available as made to order equipment.



A non-locking type manual override for easy maintenance and adjustment is standard equipment. A locking protruding type manual override for fingertip operation (optional) is also available.



Single Unit Valves Assembled Directly to T, F, and F01 Type Manifolds

Mounting valves are identical to the single unit valves, and enable economical and immediate response to system upgrades and changes in numbers of units. For systems of up to 10 units with the 2-, 3-port, use the compact T type. For combination mounting with 2-, 3-, 5-port and up to 10 units, use the F type, and for 11 or more units, use the F01 type with connection ports of Rc1/8 specification, for a truly rational, detailed choice of systems.



A plug connector with a pre-wired common terminal is available as made to order, eliminating the need for tedious common terminal wiring even on multi-unit manifolds. The result is a neatly wired multi-unit, high density solenoid valve system.

Single unit

	Direct acting solenoid valve	Pilot type solenoid valve
	2-, 3-port	5-port
Direct piping	<p>Normally closed (NC)</p>  <p>030E1</p>	<p>2-position</p>  <p>030-4E1</p>

SOLENOID VALVES 030 SERIES

Manifold

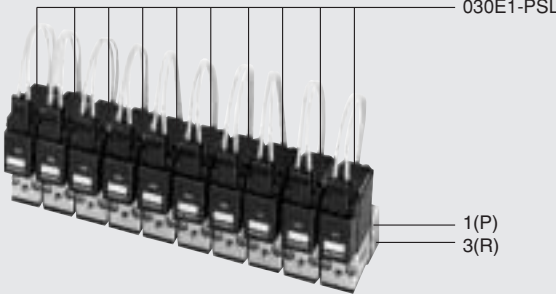
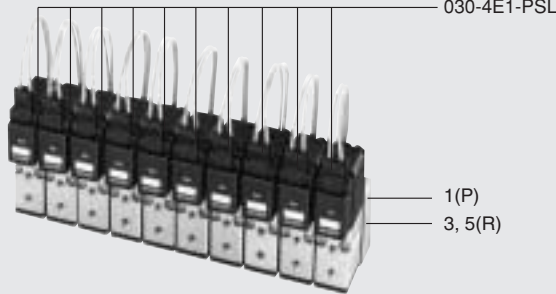
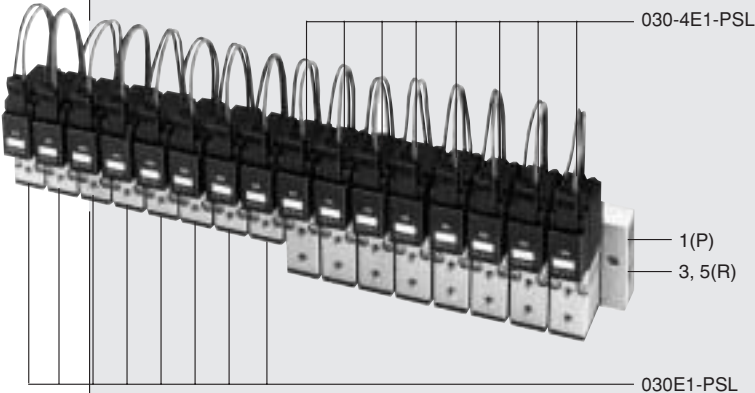
Small sized manifold for 2-, 3-port valves	Manifold for combination mounting of 2-, 3-, 5-port valves
<p>YM□T—T type (1(P), 3(R)) manifold</p>  <p>030E1-PSL</p> <p>1(P) 3(R)</p>	<p>YM□F—F type (1(P), 3, 5(R)) manifold</p>  <p>030-4E1-PSL</p> <p>1(P) 3, 5(R)</p>
	<p>YM□F01—F01 type (1(P), 3, 5(R)) manifold</p>  <p>030-4E1-PSL</p> <p>1(P) 3, 5(R)</p> <p>030E1-PSL</p>

SOLENOID VALVES

030 SERIES

Basic Models and Valve Functions

Item	Basic model Direct piping, T, F, F01 type manifolds	030E1	030-4E1
Number of positions	2 positions		
Number of ports	2, 3 ports		5 ports
Valve function	Normally closed (NC)		Single solenoid

Remark: For optional specifications and order codes, see p.91 ~ 92.

Specifications

Item	Basic model Direct piping, T, F, F01 type manifolds	030E1	030-4E1
Media	Air		
Operation type	Direct acting type		Internal pilot type
Effective area (Cv)	mm ²	1(P)→2(A) 0.6{0.03} 2(A)→3(R) 0.8{0.04}	1(P)→4(A), 2(B) 0.6{0.03} 4(A)→5(R1), 2(B)→3(R2) 0.8{0.04}
Port size <small>Note</small>	M5×0.8		
Lubrication	Not required		
Operating pressure range	MPa{kgf/cm ² } [psi.]	0~0.7 {0~7.1} [0~102]	0.15~0.7 {1.5~7.1} [22~102]
Proof pressure	MPa{kgf/cm ² } [psi.]	1.05 {10.7} [152]	
Response time	ms	DC12V, DC24V	
ON/OFF		10/25 or below	
Maximum operating frequency	Hz	15/40 or below	
Operating temperature range (atmosphere and media)	°C [°F]	5~50 [41~122]	
Shock resistance	m/s ² {G}	117.7 {12.0}	
Mounting direction	Any		

Note: For details, see the port size on p.90.

Solenoid Specifications

Item	Rated voltage							
	DC12V	DC24V	AC100V	AC200V				
Type	Flywheel diode incorporated for surge suppression		Shading type					
Operating voltage range	V	10.8~13.2 (12±10%)	21.6~26.4 (24±10%)	90~132 (100 ⁺³² / ₋₁₀ %)	180~264 (200 ⁺³² / ₋₁₀ %)			
Current (when rated voltage is applied)	Frequency	Hz	—	—	50	60	50	60
	Starting	mA (r.m.s.)	—	—	36	32	18	16
	Energizing	mA (r.m.s.)	130 (1.6W) [140 (1.7W) with LED indicator]	65 (1.6W) [75 (1.8W) with LED indicator]	24	20	12	10
Maximum allowable leakage current	mA	8	4	4	2			
Insulation resistance	MΩ	Over 100						
Wiring type and lead wire length	Standard	Grommet type: 300mm [11.8in.]						
	Optional	Plug connector type: 300mm [11.8in.] Note: See made to order on p.97~98.						
Color of lead wire	Brown (+) Black (-)	Red (+) Black (-)	Yellow	White				
Color of LED indicator	Red		Yellow	Green				
Surge suppression (as standard)	Flywheel diode		Varistor					

Cylinder Operating Speed

How to obtain cylinder speed

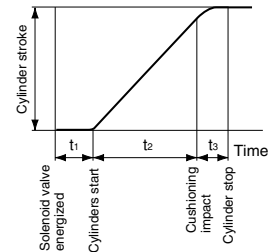

To obtain the time required for the cylinder to complete 1 stroke, add the cylinder's delay time t_1 (time between energizing of the solenoid valve and actual starting of the cylinder), to the cylinder's max. speed operating time t_2 . When a cushion is used, add the cushioning time t_3 , to the above calculations. The standard cushioning time t_3 is approximately 0.2 seconds.

Measurement conditions

- Air pressure: 0.5MPa {5.1kgf/cm²} [73psi.]
- Piping inner diameter and length:
φ 2.5 [0.1in.]×1000mm [39in.]
Quick fitting
- Fitting:
Valve side: TS4-M5
Cylinder side: TS4-M5 (φ 10, φ 16)
TS4-01 (φ 20)

- Load ratio = $\frac{\text{Load}}{\text{Cylinder theoretical thrust}}$ (%)
- Cylinder stroke: 60mm [2.36in.] (φ 10, φ 16)
100mm [3.94in.] (φ 20)

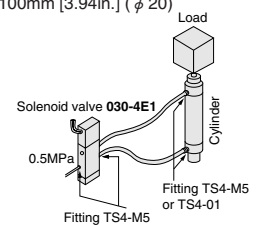

Maximum operating speed

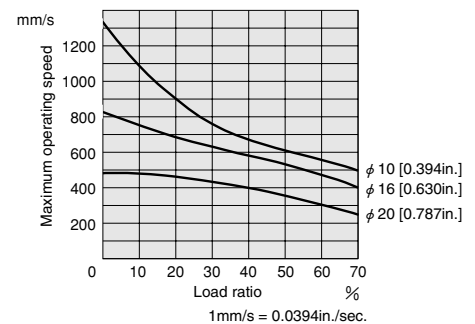

Delay time

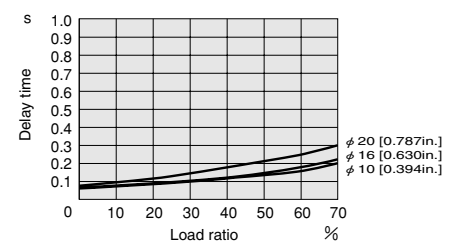

Note: Delay time changes depending on the valve construction, the volume of the cylinder and piping.

Flow Rate

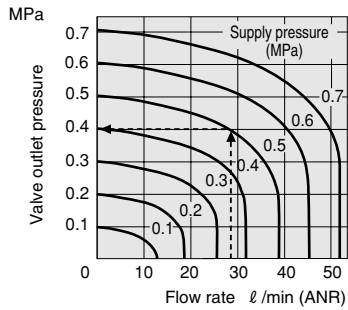

1 MPa = 145psi., 1 l/min = 0.0353ft.³/min.

How to read the graph

When the supply pressure is 0.5MPa [73psi.] and flow rate is 29 l/min [1.02ft.³/min.] (ANR), the valve outlet pressure becomes 0.4 MPa [58psi.].

Solenoid Valve Port Size

Basic model	Port	Port specification	Port size
030E1	1(P)	Female thread	M5×0.8
	2(A)		
	3(R)	—	φ 1.8
030-4E1	1(P)	Female thread	M5×0.8
	4(A), 2(B)		
	3(R2), 5(R1)	—	φ 1.8

Manifold Port Size

Manifold model	Port	Location of piping ports	Port size
YM□T	1(P)	Manifold	M5×0.8
	2(A)	Valve	
	3(R)	Manifold	M6×1
YM□F	1(P)	Manifold	M5×0.8
	4(A), 2(B)	Valve	
	3, 5(R)	Manifold	M6×1
YM□F01	1(P)	Manifold	Rc1/8
	4(A), 2(B)	Valve	M5×0.8
	3, 5(R)	Manifold	Rc1/8

Solenoid Valve Mass g [oz.]

Basic model	Mass
030E1	57 [2.01]
030-4E1	71 [2.50]

Manifold Mass g [oz.]

Manifold model	Mass calculation of each unit (n=number of units)	Block-off plate
YM□T	(11×n)−1 [(0.39×n)−0.04]	3 [0.11]
YM□F	(20.5×n)−1 [(0.72×n)−0.04]	
YM□F01	(20×n)+23 [(0.71×n)+0.81]	

030 Series Solenoid Valve Order Codes

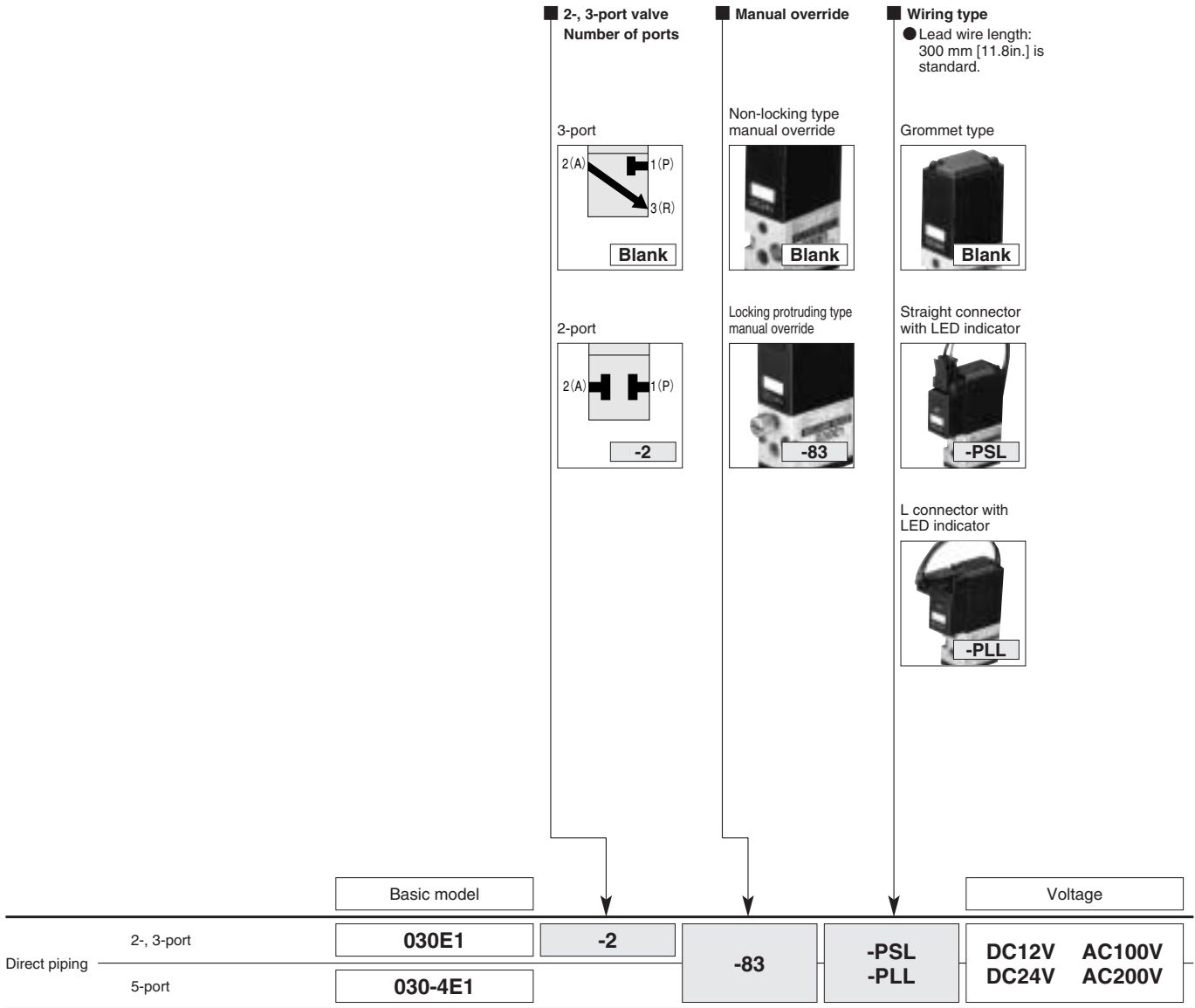

● When ordering the non-ion specification, enter -NCU after the basic model code.

Additional Parts

Muffler



KM-06

● For manifold only

Mounting base



030-21

Block-off plate



● YM | F | -BP

YM—For YM

F—For F type manifold

T—For T type manifold

F—For F type manifold

(For F01 type manifold)

T—For T type manifold

F—For F type manifold



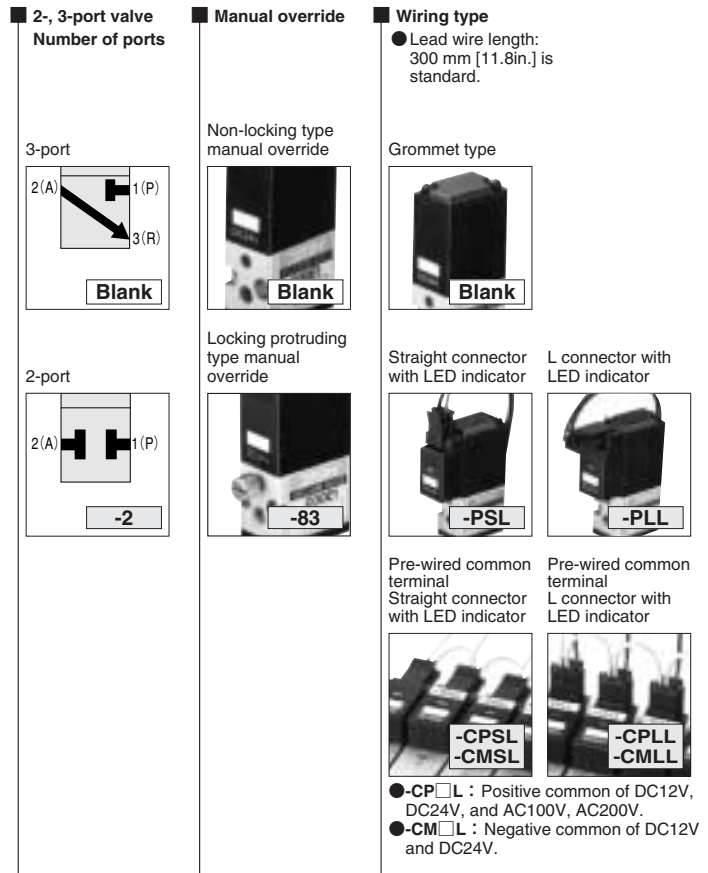



(For F01 type manifold)



	Manifold model Number of units	Station	Basic model			Voltage
Manifold for 2-, 3-port valves	YM	T	030E1	-2	-83	DC12V
Manifold for combination mounting of 2-, 3-, 5-port valves	2 ⋮ 20	F	030E1	-2	-83	DC24V
		F01	030-4E1			AC100V
		stn.1 ⋮ stn.n				AC200V

- For 11 or more stations, use **F01** only.
- Valve mounting location from the left-hand side when facing the 4(A), 2(B) ports.
- Specify the valve type for each station.
- Enter **-BP** when closing a station with a block-off plate without mounting a valve.
- When ordering the non-ion specification, enter **-NCU** after the basic model code.
- Pre-wired common terminal for AC100V and AC200V is either **-CPSL** or **-CPLL**.

Made to Order For details, see p.97~98.

<p>Straight connector with LED indicator</p>  <p>-PSLN</p> <ul style="list-style-type: none"> ● Without lead wire ● Connector and contacts included 	<p>L connector with LED indicator</p>  <p>-PLLN</p> <ul style="list-style-type: none"> ● Without lead wire ● Connector and contacts included 	<p>Lead wire length</p>  <p>-1L -3L</p> <ul style="list-style-type: none"> ● For plug connector Length -1L : 1000 [39in.] -3L : 3000 [118in.] 	<p>DIN connector</p>  <p>-39</p> <ul style="list-style-type: none"> ● Cannot be used with -L. 	<p>LED indicator with built-in varistor</p>  <p>-L</p> <ul style="list-style-type: none"> ● Cannot be used with -39. 	<p>Built-in interface unit</p>  <p>-FA</p> <ul style="list-style-type: none"> ● Can be directly controlled by output from micro computer or other logic devices. ● With LED indicator
---	--	---	---	--	---

Operating Principles and Symbols

3-port

Normally closed (NC)

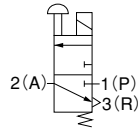

030E1

De-energized

Energized

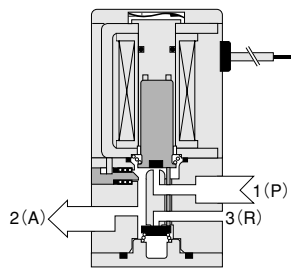
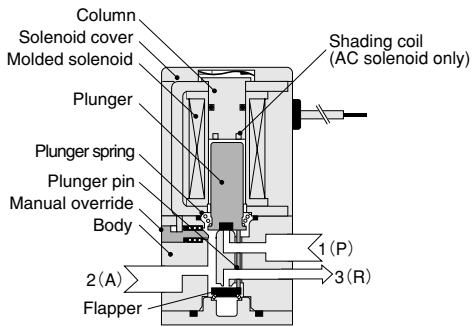

Major Parts and Materials

	Parts	Materials
Valve	Body	Aluminum alloy (anodized)
	O-ring	Synthetic rubber
	Flapper	
	Diaphragm	Synthetic rubber (urethane)
	Plunger	Magnetic stainless steel
	Column	
	Spring	Stainless steel
Mounting base	Mild steel (zinc plated)	
Manifold	Body	Aluminum alloy (anodized)
	Block-off plate	Mild steel (zinc plated)
	Bracket	Mild steel (nickel plated)
	Seal	Synthetic rubber

Remark: Materials that generate copper ions are not used for the non-ion specification.

5-port, 2-position

Single solenoid

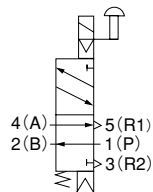

030-4E1

De-energized

Energized

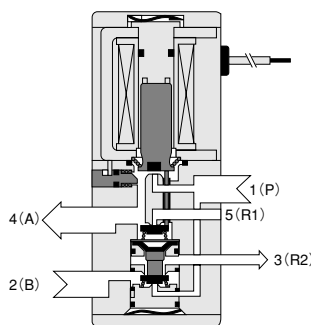
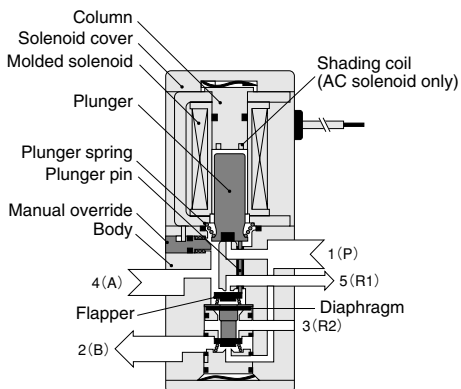

Dimensions of Solenoid Valve (mm)

030E1



030-4E1

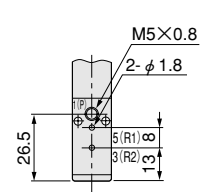
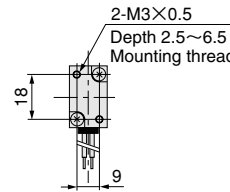
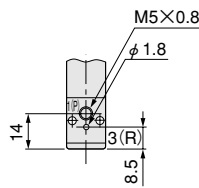
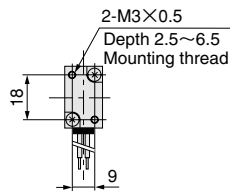
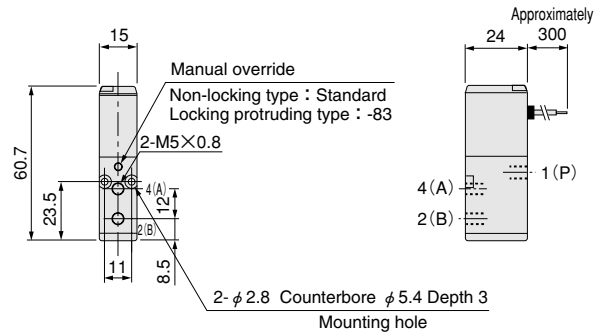
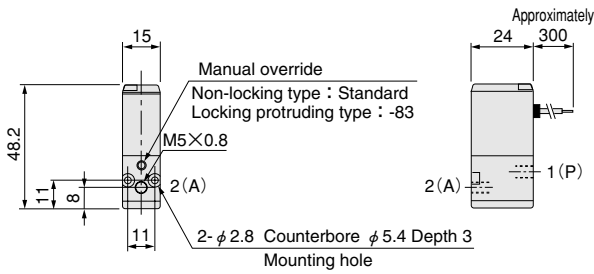

※ The lead wire direction is to the opposite side from the manual override and A, B port.

Additional Parts (To be ordered separately)

- Mounting base : 030-21

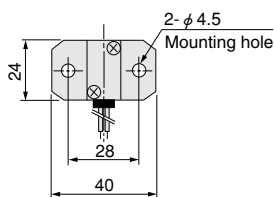
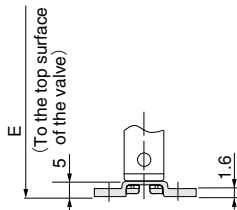

Options

- Locking protruding type manual override : -83

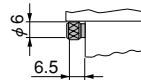
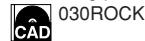

- Solenoid with straight connector : -PSL

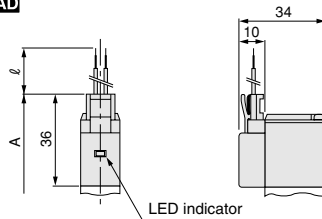

- Solenoid with L connector : -PLL

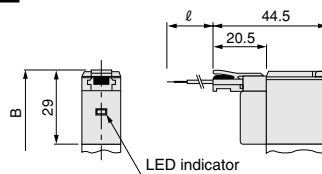

※ The lead wire direction is to the side with the manual override and 4(A), 2(B) port.

Made to Order

- Solenoid with DIN connector : -39

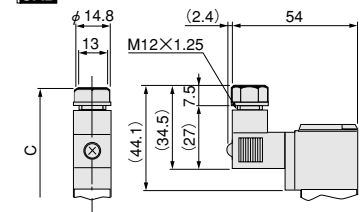

- Solenoid with LED indicator : -L

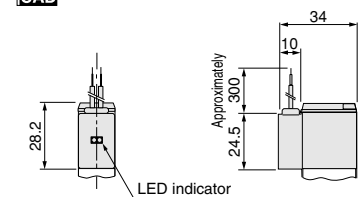

- Built-in interface unit : -FA

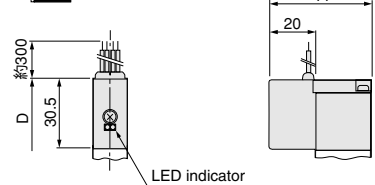

Model	Code	A	B	C	D	E	ℓ (Lead wire length)	Remarks
030E1		56	49	64.1	50.5	53.2	-PSL, -PLL: 300	Overall length to the end of the valve
030-4E1		68.5	61.5	76.6	63	65.7	Made to order: -1L: 1000, -3L: 3000	

Dimensions of Manifold for 2-, 3-port valves (mm)

YMT

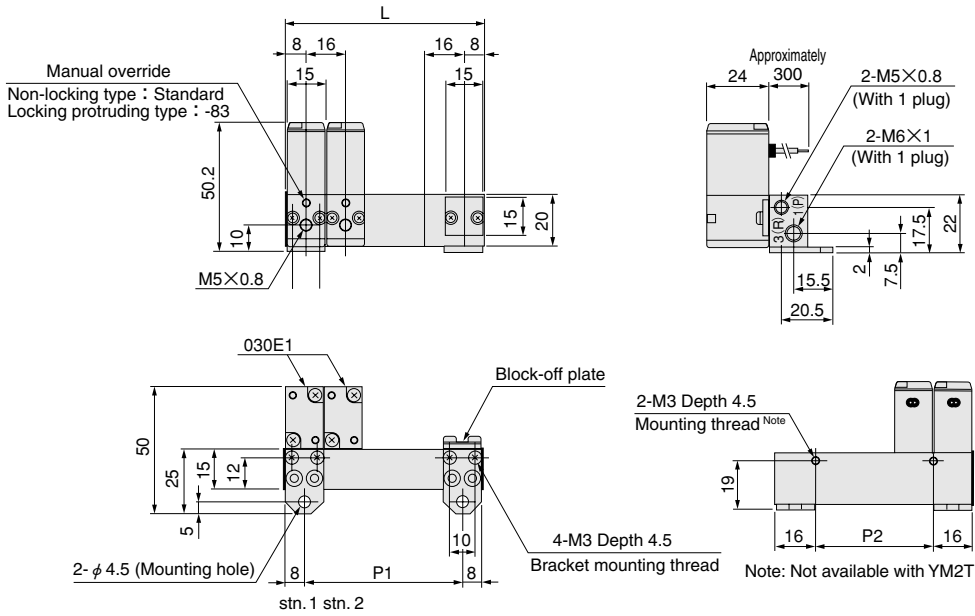

Unit dimensions

Model	L	P1	P2
YM2T	32	16	—
YM3T	48	32	16
YM4T	64	48	32
YM5T	80	64	48
YM6T	96	80	64
YM7T	112	96	80
YM8T	128	112	96
YM9T	144	128	112
YM10T	160	144	128

Additional Parts (To be ordered separately)

- Muffler : **KM-06** 030MUFF
For manifold only

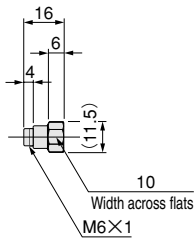

Options

- Locking protruding type manual override : **-83**
 030ROCK

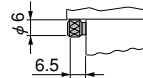

- Solenoid with straight connector : **-PSL**
 030SOL

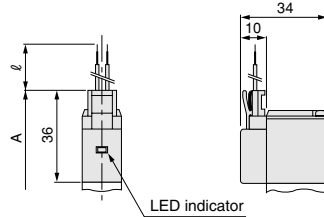

- Solenoid with L connector : **-PLL**
 030SOL

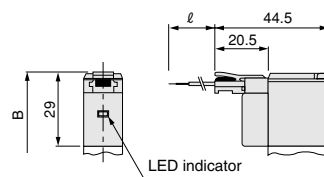

※ The lead wire direction is to the side with the manual override and 4(A), 2(B) port.

Made to Order

- Solenoid with DIN connector : **-39**
 030SOL

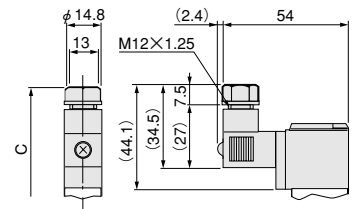

- Solenoid with LED indicator : **-L**
 030SOL

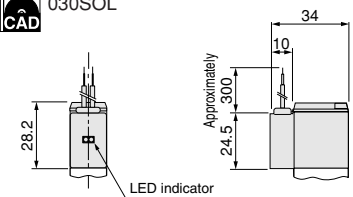

- Built-in interface unit : **-FA**
 030SOL

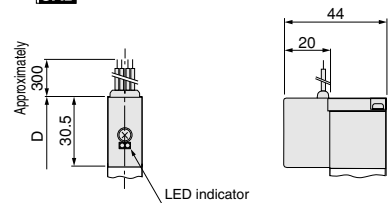

Model	Code	A	B	C	D	ℓ (lead wire length)	Remarks
	030E1	56	49	64.1	50.5	-PSL, -PLL: 300 Made to order: -1L: 1000, -3L: 3000	Overall length to the end of the valve
	030-4E1	68.5	61.5	76.6	63		

Manifold for combination mounting of 2-, 3-, 5-port valves (mm)

YM□F

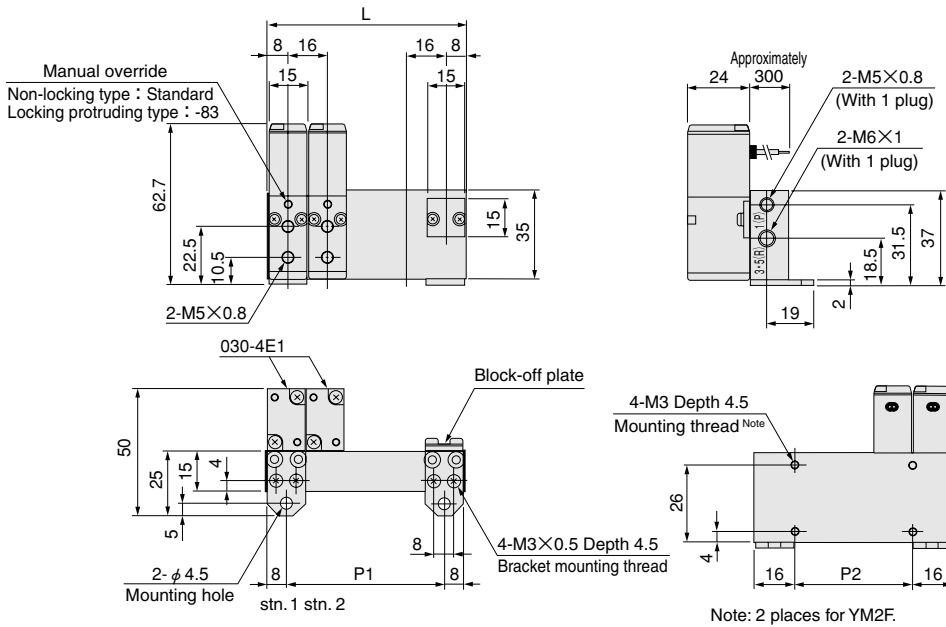

Unit dimensions

Model	L	P1	P2
YM2F	32	16	—
YM3F	48	32	16
YM4F	64	48	32
YM5F	80	64	48
YM6F	96	80	64
YM7F	112	96	80
YM8F	128	112	96
YM9F	144	128	112
YM10F	160	144	128

SOLENOID VALVES 030 SERIES

YM□F01

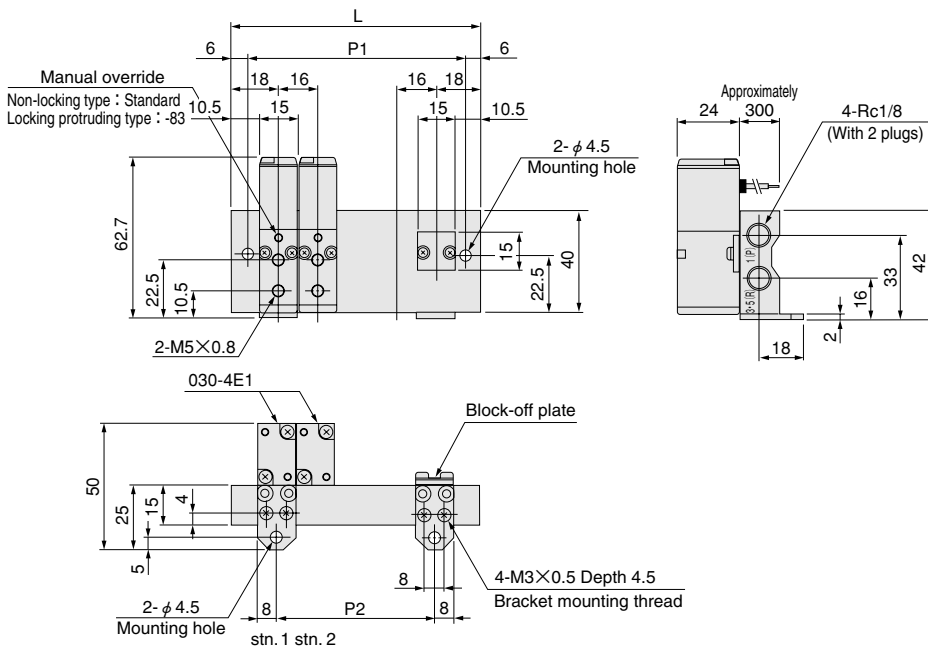

Unit dimensions

Model	L	P1	P2
YM2F01	52	40	16
YM3F01	68	56	32
YM4F01	84	72	48
YM5F01	100	88	64
YM6F01	116	104	80
YM7F01	132	120	96
YM8F01	148	136	112
YM9F01	164	152	128
YM10F01	180	168	144
YM11F01	196	184	160
YM12F01	212	200	176
YM13F01	228	216	192
YM14F01	244	232	208
YM15F01	260	248	224
YM16F01	276	264	240
YM17F01	292	280	256
YM18F01	308	296	272
YM19F01	324	312	288
YM20F01	340	328	304

Made to Order

The 030 series Solenoid Valves include a variety of made to order solenoids for application in a broader range of control and wiring types.

Plug connector

Straight connector with LED indicator



- Without lead wire
- Connector and contacts included

L connector with LED indicator



- Without lead wire
- Connector and contacts included

- When ordering, enter **-PSLN** or **-PSLL** in place of the normal option code for the wiring type.

Lead wire length

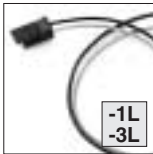

- For plug connector
- Length **-1L** : 1000 [39] mm [in.] **-3L** : 3000 [118]

- For lead wire length, **-1L** is 1000mm [39in.] and **-3L** is 3000mm [118in.].
- When ordering, enter **-1L** or **-3L** following the wiring type option code.

DIN connector



A compact connector that is highly resistant to dust and water splashes.

Employs a self-stripping method that eliminates the need for de-sheathing the lead wire.

- When ordering, enter **-39** in place of the normal option code for the wiring type.
- A varistor for surge suppression is also equipped. (For the AC100V and AC200V only. For the DC12V and DC24V, a flywheel diode for surge suppression is installed as standard equipment.)
- LED indicator is not available.

Wiring instructions

● Solenoid with DIN connector

When de-sheathing (only the outer sheath of the cable), pay attention to the lead wire direction. The cover will be easily mounted when the lead wire on the outer side of the terminal cover is set about 8mm longer than the inner side.

Without stripping off the sheath, insert the lead wire until it contacts the lead wire stopper on the terminal body, and then place the contact from the upper side. Then use pliers to press the lead wire further to ensure that the contacts are firmly touching the core wire.

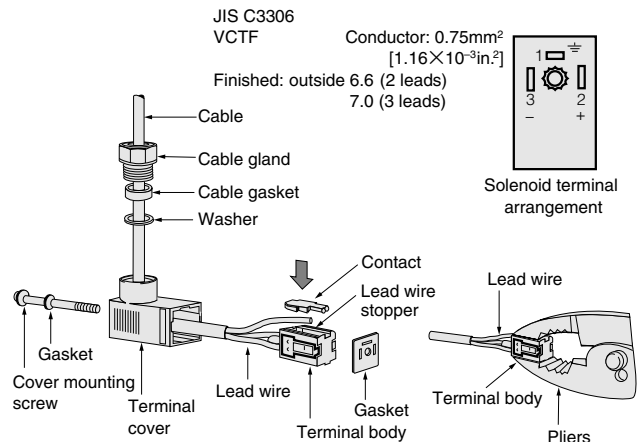

The appropriate tightening torque for the cover mounting screw is 29.4N·cm {3kgf·cm} [2.6in·lbf].

LED indicator



The LED indicator for confirmation of operation is also available without a plug connector. This creates a clean monoblock look with a compact cover.

- When ordering, enter **-L** in place of the normal option code for the wiring type.
- A varistor for surge suppression is also equipped. (For the AC100V and AC200V only. For the DC12V and DC24V, a flywheel diode for surge suppression is installed as standard equipment.)

Built-in interface unit



Includes an interface unit with photo transistor. Can be directly controlled by a microcomputer and logic chip, and is equipped with full electric noise countermeasures and LED indicators.

- When ordering, enter **-FA** in place of the normal option code for the wiring type.
- Cannot be ordered in combination with any other solenoid option.
- Rated voltages for the solenoid are AC100V and AC200V only.

Block diagram

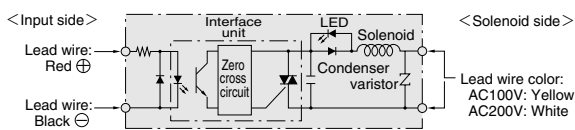

The interface unit is a triac with photo coupler. Applying DC5V to the input terminals when AC power is applied on the solenoid side causes the LED inside the unit to light up, turns on the triac, and energizes the solenoid. At this time, a LED indicator turns on.

When the input side voltage reaches 0V, the LED inside the unit shuts off, the triac is turned off, and the solenoid is de-energized. At this time, the LED indicator is turned off.

With a built-in zero-cross circuit, the zero-cross voltage is used to turn the power on, and the zero-cross current to turn it off.

Example of control circuits

1. Control by transistor

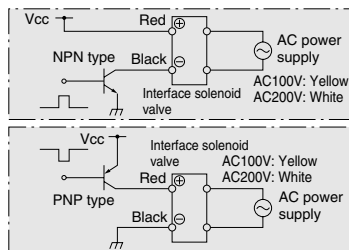

2. Control by TTL, IC

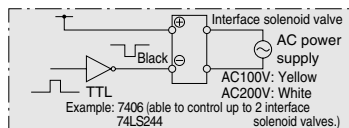

3. Control by relay contact

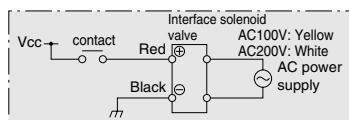

4. When input is not a DC5V power supply

Install resistance to the outside to drop the input voltage to 4~6V.

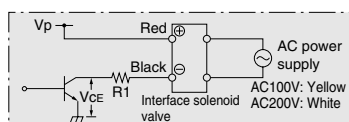

$$R1 = \frac{Vp - 5 - Vce}{18 \times 10^{-3}} [\Omega]$$

Example

Vp [V]	R1
12	390 Ω 1/4W
24	1.0K Ω 1W

In the case of Vce=0 [V]

Electrical Specifications for Solenoid Valve with Built-in Interface Unit

Item		Specifications				
Input side	Rated voltage	DC V	5			
	Voltage range	DC V	4~6			
	Current (when 5V DC is applied)	mA	18			
	Operating voltage	DC V	4 or below			
	Return voltage	DC V	0.8 or over			
	Color of lead wire		Red (+), Black (-)			
Solenoid side	Rated voltage	AC V	100	200		
	Type		Shading type			
	Operating voltage range	AC V	90~125 (100 ^{+25%} _{-10%})	180~250 (200 ^{+25%} _{-10%})		
	Current (when rated voltage is applied)	Frequency Hz	50	60	50	60
		Starting mA (r.m.s.)	36	32	18	16
		Energizing mA (r.m.s.)	24	20	12	10
	Leakage current	Frequency Hz	50	60	50	60
		Current mA (r.m.s.)	0.3	0.4	0.6	0.8
	Surge suppression (as standard)		Built-in varistor at solenoid side			
	Color of lead wire		Yellow	White		
	Color of LED indicator (as standard)		Yellow	Green		
Dielectric voltage		Min. AC1500V on input side and solenoid side				
Insulation resistance	MΩ	Between input side and solenoid side, and between whole terminals and body		Over 100		
Zero-cross function		Available				
Wiring type and lead wire length		Grommet type: 300mm [11.8in.]				

Wiring instructions

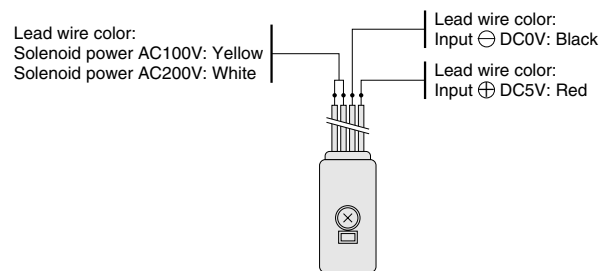

1. Separate the input side and solenoid side lead wires by color. Never apply AC power/6VDC or more to the input side.
2. Ensure that voltage ripple on the input side remains within the range shown below:

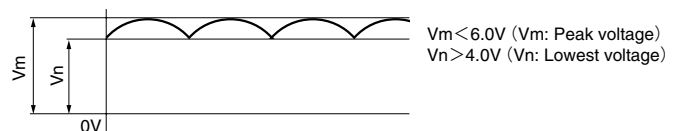

3. Even when a wrong polarity is applied to the input side, a built-in diode for protection against reverse polarity eliminates any worry about short circuiting. The valve will not operate, however.
4. A varistor and condenser are built-in to the solenoid power supply side, for protection circuit against external surge voltages. As a result, there is a 0.3mA leakage current in AC100V, and a 0.6mA leakage current in AC200V.
5. The operation and return times of the interface unit are 10ms or less with a 50Hz AC power supply, and 8ms or less with a 60Hz AC power supply.

Handling Instructions and Precautions



Solenoid

Internal circuit

● DC12V, DC24V

Standard solenoid (Surge suppression)

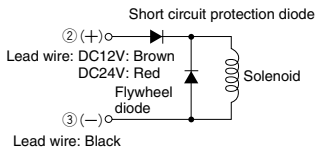

② and ③ are for with DIN connector (order code: -39).

Solenoid with LED indicator (Surge suppression)

Order code: -PSL, -PLL

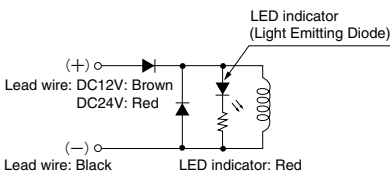

● AC100V, AC200V

Standard solenoid (Surge suppression)

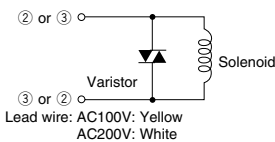

② and ③ are for with DIN connector (order code: -39).

Solenoid with LED indicator (Surge suppression)

Order code: -PSL, -PLL

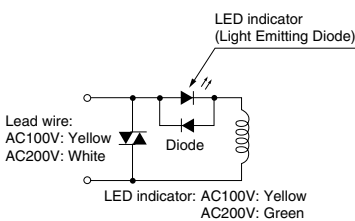

Cautions: 1. Do not apply megger between the lead wires.

2. The DC solenoid will not short circuit even if the wrong polarity is applied, but the valve will not operate.
3. Leakage current inside the circuit could result in failure of the solenoid valve to return, or in other erratic operation. Always use it within the range of the allowable leakage current. If circuit conditions, etc. cause the leakage current to exceed the allowable leakage current, consult us.



Plug connector

Attaching and removing plug connector

Use fingers to insert the connector into the pin, push it in until the lever claw latches onto the protruded section of the connector housing, and complete the connection.

To remove the connector, squeeze the lever along with the connector, lift the lever claw from the protruded section of the connector housing, and pull it out.

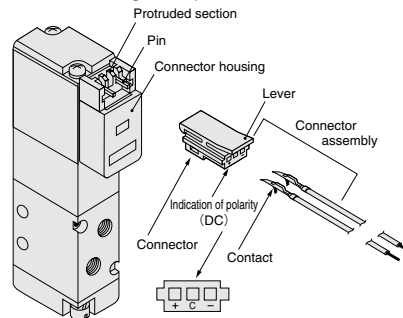

※ Illustration shows the 110 series.

Crimping of connecting lead wire and contact

To crimp lead wires into contacts, strip off 4mm [0.16in.] of the insulation from the end of the lead wire, insert it into the contact, and crimp it. Be sure at this time to avoid catching the insulation on the exposed wire crimping section.

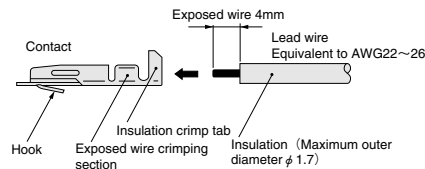

- Cautions:** 1. Do not pull hard on the lead wire.
 2. Always use a dedicated tool for crimping of connecting lead wire and contact.
 Contact: Model 702062-2M
 Manufactured by Sumiko Tech, Inc.
 Crimping tool: Model F1-702062
 Manufactured by Sumiko Tech, Inc.

Attaching and removing contact and connector

Insert the contact with a lead wire into a plug connector hole until the contact hook latches on and is secured to the plug connector. Confirm that the lead wire cannot be easily pulled out.

To remove it, insert a tool with a fine tip (such as a small screwdriver) into the rectangular hole on the side of the plug connector to push up on the hook, and then pull out the lead wire.

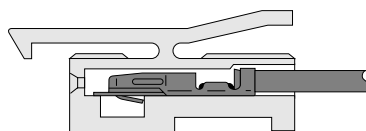

- Cautions:** 1. Do not pull hard on the lead wire. It could result in defective contacts, breaking wires, etc.
 2. If the pin is bent, use a small screwdriver, etc. to gently straighten out the pin, and then complete the connection to the plug connector.

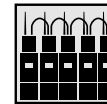

Common terminal pre-wired plug connector

1. Pre-wired common terminal at DC positive side or AC.

Order code With straight connector: -CPSL
 With L connector: -CPLL

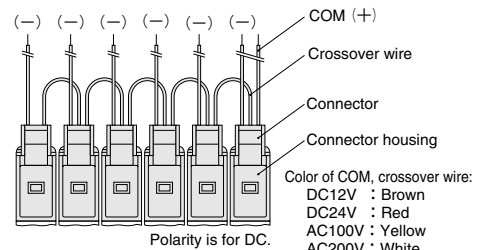

2. Pre-wired common terminal at DC negative side

Order code With straight connector: -CMSL
 With L connector: -CMLL

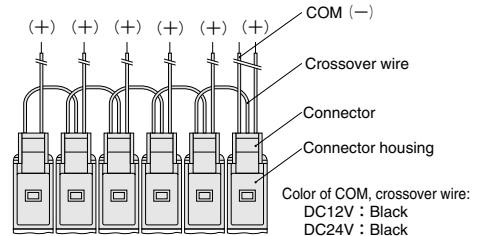

Cautions: 1. The diagrams show the straight connector configuration.

While the connector's orientation is different in the case of the L connector, in every case the first COM lead wire comes from the last station's mounted valve.

2. Since the COM terminal is connected to a crossover terminal inside the connector housing, the connector cannot be switched between a positive common and a negative common by changing the connectors.



Manual override

Non-locking type

To operate the manual override, press it all the way down. The valve works the same as when in the energized state as long as the manual override is pushed down, and returns to the rest position upon release.

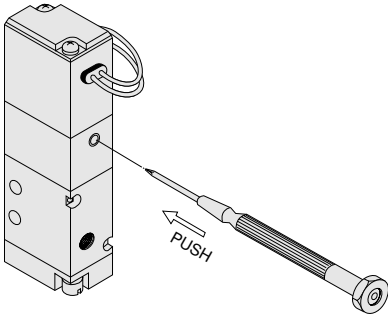

※ Illustration shows the 110 series.

Locking protruding type

Use a small screwdriver to turn the adjusting knob several times in the clockwise direction, and lock the manual override in place.

When locked, turning the adjusting knob several times in the counterclockwise direction releases a spring on the manual override, returns it to the original position, and releases the lock.

For the locking protruding type, when the adjusting knob is not turned, this type acts just like the non-locking type, the valve is energized as long as the manual override is pushed down, and it returns to the rest position upon release.

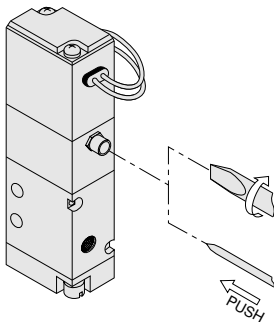

※ Illustration shows the 110 series.

- Cautions:**
1. In the pilot type solenoid valve, the manual override cannot switch the main valve without air supplied from the 1(P) port.
 2. Always release the lock of the locking protruding type manual overrides before commencing normal operation.
 3. Do not attempt to operate the manual override with a pin or other object having an extremely fine tip. It could damage the manual override button.
 4. Do not turn the adjusting knob more than needed. It could result in defective operation.

Mounting base 030-21

When installing a mounting base to the valve, always use the provided screws. The recommended tightening torque for the screws is $49\text{N} \cdot \text{cm}$ $\{5\text{kgf} \cdot \text{cm}\}$ $[4.3\text{in} \cdot \text{lbf}]$.

Mounting valves on manifold

When mounting valves on manifold, apply the recommended tightening torque of $39.2\text{N} \cdot \text{cm}$ $\{4\text{kgf} \cdot \text{cm}\}$ $[3.5\text{in} \cdot \text{lbf}]$ for the valve mounting screws.