

SHOCK ABSORBER Series

Fixed Absorption Capacity Linear Orifice Type

KSHJ Series

Page 571

Total of 12 sizes and 66 models from M4 to M27 size.

Offers wide range of speeds, with maximum impact speed of 0.8 m/s to 3 m/s^{Note}.

Note: The maximum impact speed varies by model.
See specification table on p.571.



● With cap



● With stopper nut



● With side mounting bracket



What is the linear orifice type?

Use of a linear orifice mechanism, in which the orifice changes linearly, ensures smooth shock absorption.

Achieves the performance of shock absorbers with next-size-up stroke lengths, to reduce vibrations on mounting frames and equipment.

Reduces the shock value in impacts, to lower the noise during workpiece impacts.

Operation principle

The piston stroke linearly squeezes the oil path, for soft absorption of shocks.

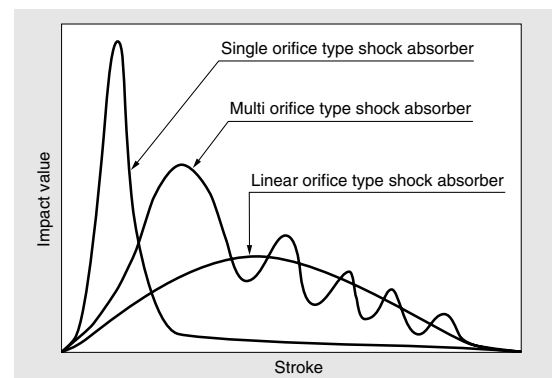
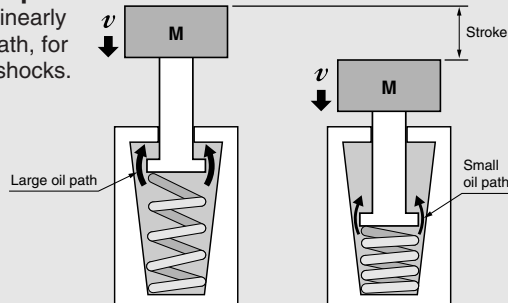

Fixed Absorption Capacity Linear Orifice Type

KSHA Series

Page 579

Total of five sizes, from M6 to M14.
All sizes can be set with heavy load and light load absorption capacities.



● Insert mounting type



● With cap



● With stopper nut



● With flange mounting bracket



● With side mounting bracket



KSHC Series (Clean Room Specification) Class 5 (Equivalent to FED-STD209E Class 100) compatibility

Page 585

Total of eight sizes, from M6 to M25.
Uses a special particle pocket structure, to prevent flying dust out.



● With cap



● With stopper nut



Safety Precautions (Shock Absorbers)

The following is a safety precaution to Shock Absorbers. For other safety precautions, be sure to read the precautions on p.49.

Danger

- Do not touch or approach too close to the product while it is in operation. Also, do not attempt to mount a shock absorber or adjust operations while devices are operating. Unintended movement of devices could result in personal injury.

Warning

- Never loosen or remove the small screw on the rear end surface of the shock absorber. The oil inside will leak out and damage shock absorber function, which could result in injury.
- For product mounting, always observe the handling instructions and precautions. In addition, when a product has been mounted, before starting operation always check whether mounting nuts have been attached and are secured, etc. Looseness in the mounting nuts could lead to equipment damage, or to accidents.

Caution

- Do not coat the sliding sections with any lubricant whatsoever. Such lubrication could alter or degrade the properties of the product materials, or reduce performance.
- Attempting to use the shock absorber with cap over the specification range could result in damage to the cap or to its flying off and causing personal injury. Moreover, if cracks or fractures appear in the cap, replace it as quickly as possible.

Attention

- When the product's service life is completed or when it is no longer needed, dispose of it as an industrial waste product, in accordance with the Waste Disposal and Public Cleaning Law, or with other local laws and ordinances. Note that because the special oil used in the KSHC series (clean room specification) gives off hydrofluoric acid, a corrosive, toxic substance, when incinerated, disposal should be performed at an incinerator equipped with acid-resisting toxic removal facilities. If large volumes need disposal, consign the operation to a registered waste disposal company.
- The maximum absorption performance in the specifications are values at normal temperatures (20~25°C [68~77°F]). Be aware that performance and characteristics may change depending on the operating temperature.
- The shock absorber's absorption capacity can change depending on the impact speed. Use it within the range shown in the selection graphs (impact mass and impact speed graphs) on p.572, 580, 586 and 593.

Handling Instructions and Precautions



General precautions

If mounting in locations subject to dripping water, dripping oil, etc., or to large amounts of dust, use something to cover and protect the unit. Accumulations of water, oil, or dust can reduce the shock absorber's service life.



Adjustment of shock absorption capacity

● Adjustable absorption capacity type : KSHE and KSH series

1. Align the white mark on the shock absorption adjusting knob to 2 or 3 on the scale.
2. For cases where the stroke end is still undergoing shocks, turn the adjusting knob toward 6 on the scale. In cases where the rod stops before the preset stroke end, or when the shock at time of impact is very large, turn the adjusting knob toward "0" on the scale.
3. When adjustment is complete, always be sure to tighten the lock screw to secure the adjusting knob in place.
4. The KSHE series are designed so that the final orifice hole is closed at the stroke end. Shortening the stroke could lead to an inability to adequately absorb the impact energy. It is recommended that use of the full stroke be made. Moreover, the shock absorber for the KSHE series operate differently when its rod is manually pushed in as opposed to actual operation.

● Fixed absorption capacity type : KSHJ, KSHA, KSHC series

For the fixed absorption capacity type, shock absorption capacity cannot be adjusted. See the Selection Guideline on p.572, 580, 586 to select a model with the optimum shock absorption capacity.



Mounting

1. Mount the shock absorber so that the load contacts at the center of the rod, and it is not subjected to off-centered loads. An off-centered load could result in breakage or defective rod returns. If there is concern that off-centered loads will occur, install a guide, etc.
2. Two or more shock absorbers can be mounted in parallel, to boost absorption capacity. In such an arrangement, however, be careful to ensure that the load is evenly distributed to each shock absorber.
3. The surface in direct contact with the shock absorber rod should have a hardness of HRc40 or more (excluding with cap models).
4. When mounting the shock absorber, do not exceed the maximum tightening torque for the hexagon nut, shown in the table below. Excessive tightening could damage the unit.

Model	N · m [ft · lbf]	
	Maximum tightening torque	
KSHJ4×3 (C) -01,-02	0.5 [0.37]	
KSHJ6×4 (C) -01,-02	0.85 [0.63]	
KSHJ8×5 (C) -01,-11	2.5 [1.8]	
KSHJ8×8 (C) -01,-02,-11,-12	2.5 [1.8]	
KSHJ10×10 (C) -01,-02	6.5 [4.8]	
KSHJ10×15 (C) -01,-03	6.5 [4.8]	
KSHJ12×10 (C) -01,-02	6.5 [4.8]	
KSHJ14×12 (C) -01,-02	12.0 [8.9]	
KSHJ16×15 (C) -01,-02	20.0 [14.8]	
KSHJ18×16 (C) -01,-02	25.0 [18.4]	
KSHJ20×16 (C) -01,-02	30.0 [22.1]	
KSHJ22×25 (C) -01,-02	35.0 [25.8]	
KSHJ25×25 (C) -01,-11,-12	42.0 [31.0]	
KSHJ27×25 (C) -01,-02,-11,-12	42.0 [31.0]	

Handling Instructions and Precautions

N·m [ft·lbf]	
Model	Maximum tightening torque
KSHA4×4, CS-KSHC4×4	0.85 [0.63]
KSHA5×5, CS-KSHC5×5	2.5 [1.84]
KSHA6×5	6.5 [4.79]
KSHA6×8, CS-KSHC6×8	
KSHA7×8, CS-KSHC8×8	12.0 [8.85]
KSHA8×10, CS-KSHC9×10	
CS-KSHC11×15C	20.0 [14.8]
CS-KSHC14×16C	30.0 [22.1]
CS-KSHC18×25C	42.0 [31.0]

N·m [ft·lbf]	
Model	Maximum tightening torque
KSHE5×8, KSH5×8	8.0 [5.90]
KSHE6×10, KSH6×10	
KSHE(S)8×15, KSH8×10	15.0 [11.1]
KSHE(S)10×20, KSH10×15	24.0 [17.7]
KSHE(S)12×22, KSH12×22	30.0 [22.1]

● Fixed absorption capacity type KSHJ, KSHA, KSHC series

1. If using "with cap" or changing the stroke to adjust absorption capacity, use a stopper.
2. If using "with cap", always mount a stopper nut (-S) or an external stopper to ensure that the cap is not subjected to loads at the stroke end. For the stopper nut mounting position, see the dimensions in the table below.
While the shock absorber can be used without a stopper nut (-S) or external stopper, in such an arrangement, the stop position may change due to deformation of the cap after a long period of use.

mm [in.]	
Model	A
KSHJ4×3C-01,-02	3 [0.118]
KSHJ6×4C-01,-02	4 [0.157]
KSHJ8×5C-01,-11	5 [0.197]
KSHJ8×8C-01,-02,-11,-12	8 [0.315]
KSHJ10×10C-01,-02	10 [0.394]
KSHJ10×15C-01,-03	15 [0.591]
KSHJ12×10C-01,-02	10 [0.394]
KSHJ14×12C-01,-02	12 [0.472]
KSHJ16×15C-01,-02	15 [0.591]
KSHJ18×16C-01,-02	16 [0.630]
KSHJ20×16C-01,-02	16 [0.630]
KSHJ22×25C-01,-02	25 [0.984]
KSHJ25×25C-01,-11,-12	25 [0.984]
KSHJ27×25C-01,-02,-11,-12	25 [0.984]

mm [in.]	
Model	A
KSHA4×4C, CS-KSHC4×4C	3.5~3.9 [0.138~0.154]
KSHA5×5C, CS-KSHC5×5C	4.5~4.9 [0.177~0.193]
KSHA6×5C	
KSHA6×8C, CS-KSHC6×8C	7.5~7.9 [0.295~0.311]
KSHA7×8C, CS-KSHC8×8C	
KSHA8×10C, CS-KSHC9×10C	9.5~9.9 [0.374~0.390]
CS-KSHC11×15C	14.5~14.9 [0.571~0.587]
CS-KSHC14×16C	15.5~15.9 [0.610~0.626]
CS-KSHC18×25C	24.5~24.9 [0.965~0.980]

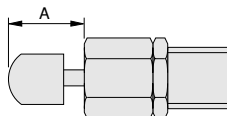

3. For swing impacts, ensure that the angle of eccentricity between the load direction and the center line of the shock absorber is at or below the specification values shown on p.571, p.579 and p.585.
4. Do not loosen or remove the small screw on the rear end of the shock absorber. The oil contained inside could leak out, damaging shock absorber functions.

● Insert mounting : KSHA□×□□-X

1. For the dimensions of the mounting hole for the insert mount, see the insert mounting hole drawings on p.583.
2. When using a panel mounting, use the values in the table below to determine the maximum thickness of the panel.

mm [in.]	
Model	Maximum panel thickness
KSHA6×8□-X	8 [0.315]
KSHA7×8□-X	10 [0.394]

● Adjustable absorption capacity type KSHE and KSH series

1. Do not use the end surface of the shock absorber body in the rod side as a stopper. Always use a stopper nut (Order code: -S) or external stopper.
2. When using the stopper nut, adjust the stopper nut location so that it protrudes 0.5 mm [0.02 in.] from the end surface of the KSHE series shock absorber body, and 0.5 to 1.0 mm [0.02 to 0.04 in.] from the KSH series.
3. When using an external stopper, mount so that impacting objects are stopped 0.5 mm [0.02 in.] in front of the end surface of the KSHE series shock absorber body, and 0.5 to 1.0 mm [0.02 to 0.04 in.] in front of the KSH series.
4. For swing impacts, ensure that the angle of eccentricity between the load direction and the center line of the shock absorber is 3° or less.

KSHES series

1. For holders that can directly stop loads, use a stopper type holder (-HS). If using holders that do not have a stopper function (-H), use an external stopper.
2. Holders and external stoppers should receive all the remaining energy for loads when stopping. Do not let the cap become subjected to loads at the stroke end.

● Calculation

For the calculations, use the speed immediately before striking the absorber. For air cylinders, the speed immediately before striking is larger than the average speed obtained from the "time required for cylinder stroke". In this case, shorter strokes increase the speed, and it reaches 1.2 to 2.0 times higher than the average speed.

Selection procedure of shock absorber

Impact mass m kg
 [Impact weight w' lbf.]
 Impact speed v m/s [ft./sec.]

When additional energy is not applied.

When additional energy from the cylinder, rotary actuator, etc., is applied

Item	Horizontal impact		Horizontal impact		Vertical impact		Swing impact			
	Simple horizontal impact		Cylinder impact	Free fall	Cylinder impact	Arm swing	Turn table			
Impact example										
Impact mass m kg [Impact weight w' lbf.]	m	w'	m	w'	m	w'	m	w'	m	w'
Impact speed v m/s [ft./sec.]	v		v		v		$v=R \cdot \omega$		$v=R \cdot \omega$	
Kinetic energy E_1 J [ft·lbf]	$\frac{m \cdot v^2}{2}$	$\left\{ \frac{w' \cdot v^2}{2 \cdot g} \right\}$	$\frac{m \cdot v^2}{2}$	$\left\{ \frac{w' \cdot v^2}{2 \cdot g} \right\}$	$m \cdot g \cdot h$	$\left\{ w' \cdot h \right\}$	$\frac{m \cdot v^2}{2}$	$\left\{ \frac{w' \cdot v^2}{2 \cdot g} \right\}$	$\frac{I \cdot \omega^2}{2}$	$\left\{ \frac{I' \cdot \omega^2}{2} \right\}$
Thrust, mass, and other additional energy E_2 J [ft·lbf]	—		$F \cdot L$	$\left\{ F \cdot L \right\}$	$m \cdot g \cdot L$	$\left\{ w' \cdot L \right\}$	$(m \cdot g + F) \cdot L$	$\left\{ (w' + F) \cdot L \right\}$	$\frac{T \cdot L}{R}$	$\left\{ \frac{T' \cdot L}{R} \right\}$
Total energy E J [ft·lbf]	E_1		$E_1 + E_2$		$E_1 + E_2$		$E_1 + E_2$		$E_1 + E_2$	

Shaded areas show calculations using the imperial units.
 [] shows imperial units.

Maximum operating frequency cycle/min
 Operating ambient temperature °C [°F]

Select models where the m, v, E, L , operating frequency and temperature satisfy the specifications.

Remark: The shock absorber's absorption energy will vary depending on speed, temperature, and other conditions. This calculation equation is provided for a general indication only. We recommend selecting from the selection graphs on p.572~573, 580, 586, and 593.

Code explanations	(Unit)
m : Impact mass	kg
w' : Impact weight	[lbf.]
v : Impact speed	m/s [ft./sec.]
E : Total energy	J [ft·lbf]
E_1 : Kinetic energy	J [ft·lbf]
E_2 : Additional energy	J [ft·lbf]
g : Acceleration of gravity	9.8m/s ² [32.2ft./sec. ²]
F : Cylinder thrust	N
$F = \pi / 4 \times D^2 \times P$	
D : Bore size	mm
P : Operating air pressure	MPa
F : Cylinder thrust	N
F' : Cylinder thrust	[lbf.]
$F' = \pi / 4 \times D'^2 \times P'$	
D' : Bore size	[in.]
P' : Operating air pressure	[psi. = lbf./in. ²]
L : Shock absorber stroke	m [ft.]
h : Height of fall	m [ft.]
T : Torque	N·m
T' : Torque	[ft·lbf]
ω : Angular velocity (90° = 1.57rad.)	rad/s
N : Rotating speed $\omega = 2 \pi N / 60$	rpm
R : Distance from center of rotation to point of impact	m [ft.]
I : Inertia moment relating to center of gravity	kg·m ²
I' : Inertia moment relating to center of gravity	[ft·lbf·sec ²]

CLEAN ROOM SPECIFICATION
SHOCK ABSORBERS
 LINEAR ORIFICE TYPE

KSHC Series



Specifications

Item	Model	CS-KSHC4×4□-B	CS-KSHC4×4□-BD	CS-KSHC5×5□-D(-11)	CS-KSHC5×5□-DE(-11)
Mounting thread size		M6×0.75		M8×0.75(M8×1) ^{Note2}	
Maximum absorption	J [ft·lbf]	0.3 [0.22]	0.5 [0.37]	1.0 [0.74]	1.5 [1.11]
Absorbing stroke	mm [in.]	4 [0.16]		5 [0.20]	
Maximum impact speed	m/s [ft./sec.]	1.0 [3.28]			
Maximum operating frequency	cycle/min	60			
Maximum absorption per unit of time	J/min [ft·lbf/min.]	15 [11.1]		45 [33.2]	
Spring return force	N [lbf.]	3.0 [0.67]		6.0 [1.35]	
Angle variation		1° or less			
Operating temperature range ^{Note1}	°C [°F]	0~60 [32~140]			

Item	Model	CS-KSHC6×8□-DE	CS-KSHC6×8□-EF	CS-KSHC8×8□-EF	CS-KSHC8×8□-G
Mounting thread size		M10×1		M12×1	
Maximum absorption	J [ft·lbf]	1.5 [1.11]	2.5 [1.84]	2.5 [1.84]	4.0 [2.95]
Absorbing stroke	mm [in.]	8 [0.32]			
Maximum impact speed	m/s [ft./sec.]	1.0 [3.28]			
Maximum operating frequency	cycle/min	60			
Maximum absorption per unit of time	J/min [ft·lbf/min.]	75 [55.3]		120 [89]	
Spring return force	N [lbf.]	8.5 [1.91]			
Angle variation		1° or less			
Operating temperature range ^{Note1}	°C [°F]	0~60 [32~140]			

Item	Model	CS-KSHC9×10□-GK	CS-KSHC9×10□-L	CS-KSHC11×15□-M	CS-KSHC11×15□-P
Mounting thread size		M14×1.5		M16×1.5	
Maximum absorption	J [ft·lbf]	5.0 [3.69]	8.0 [5.90]	10 [7.4]	15 [11.1]
Absorbing stroke	mm [in.]	10 [0.39]		15 [0.59]	
Maximum impact speed	m/s [ft./sec.]	1.0 [3.28]			
Maximum operating frequency	cycle/min	60		40	
Maximum absorption per unit of time	J/min [ft·lbf/min.]	240 [177]		300 [221]	
Spring return force	N [lbf.]	8.5 [1.91]		18 [4.0]	
Angle variation		1° or less			
Operating temperature range ^{Note1}	°C [°F]	0~60 [32~140]			

Item	Model	CS-KSHC14×16□-R	CS-KSHC14×16□-T	CS-KSHC18×25□-X	
Mounting thread size		M20×1.5		M25×1.5	
Maximum absorption	J [ft·lbf]	20 [14.8]	30 [22.1]	40 [29.5]	
Absorbing stroke	mm [in.]	16 [0.63]		25 [0.98]	
Maximum impact speed	m/s [ft./sec.]	1.0 [3.28]			
Maximum operating frequency	cycle/min	40			
Maximum absorption per unit of time	J/min [ft·lbf/min.]	600 [443]		800 [590]	
Spring return force	N [lbf.]	18.6 [4.18]		32 [7.2]	
Angle variation		1° or less			
Operating temperature range ^{Note1}	°C [°F]	0~60 [32~140]			

Notes: 1. Shock absorption capacity fluctuates depending on ambient temperature or speed.
 2. The value inside () is CS-KSHC5×5□-□-11.

Selection Guideline

Precautions for Use of Selection Graphs

1. The selection graphs show the best conditions for usage of the product with horizontal impacts.
2. The selection graphs are calculated for a cylinder with air pressure of 0.5 MPa [73 psi.].

● Selection Graphs

CS-KSHC4 × 4

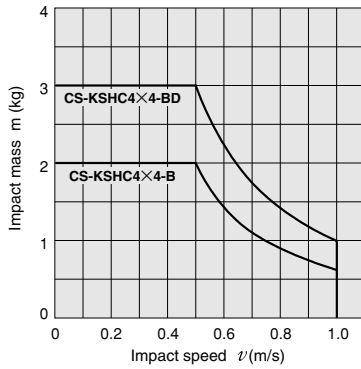

CS-KSHC5 × 5

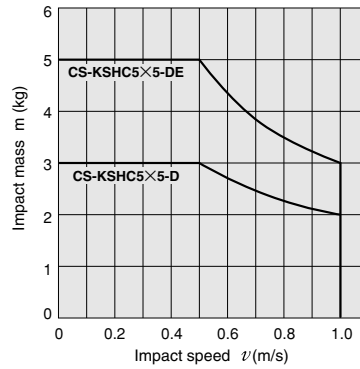

CS-KSHC6 × 8

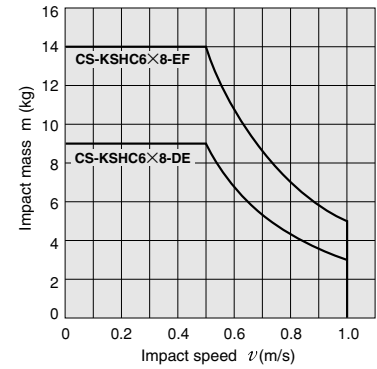

CS-KSHC8 × 8

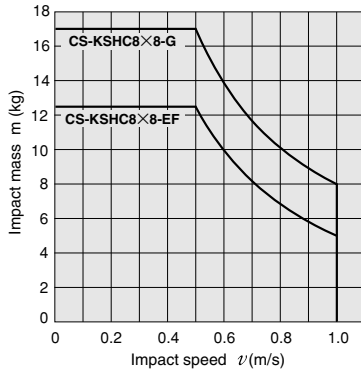

CS-KSHC9 × 10

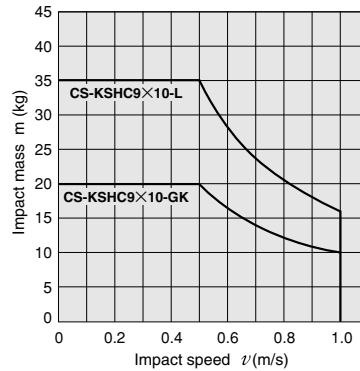

CS-KSHC11 × 15

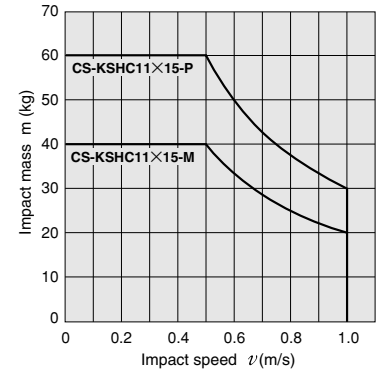

CS-KSHC14 × 16

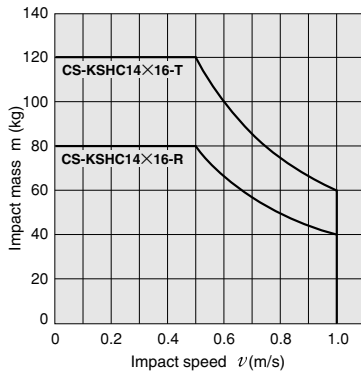

CS-KSHC18 × 25

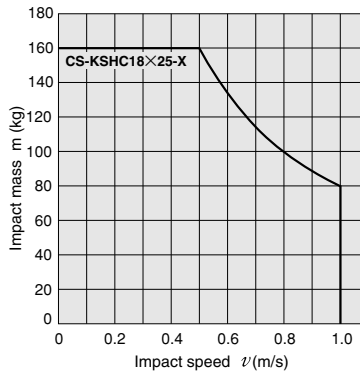

1 kg = 2.20 lb. 1 m/s = 3.28 ft./sec.

SHOCK ABSORBERS

■ Recommended bore size

Model	Bore size	ϕ 6	ϕ 8	ϕ 10	ϕ 16	ϕ 20	ϕ 25	ϕ 32	ϕ 40	ϕ 50	ϕ 63	ϕ 80	ϕ 100
	mm [in.]	[0.236]	[0.315]	[0.394]	[0.630]	[0.787]	[0.984]	[1.260]	[1.575]	[1.969]	[2.480]	[3.150]	[3.937]
CS-KSHC4 × 4		○	○	○									
CS-KSHC5 × 5			○	○	○								
CS-KSHC6 × 8				○	○	○							
CS-KSHC8 × 8					○	○	○						
CS-KSHC9 × 10					○	○	○	○					
CS-KSHC11 × 15						○	○	○	○				
CS-KSHC14 × 16								○	○	○	○		
CS-KSHC18 × 25									○	○	○	○	○

Note: The above table shows the recommended sizes. This does not necessarily exclude the use of cylinders in other sizes.

Order Codes

CS — **KSHC** — — —

Clean room specification

Shock Absorbers Linear Orifice Type KSHC Series

Rod end type
Blank : No cap
C : With cap

Stopper nut
Blank : No stopper nut
S : With stopper nut^{Note}

Note: The stopper nut is an option available for models with cap (C) only.

Order codes for CS-KSHC5×5 thread size M8×1

CS-KSHC5×5 — — — **11**

Rod end type
Blank : No cap
C : With cap

Stopper nut
Blank : No stopper nut
S : With stopper nut^{Note}

Note: The stopper nut is an option available for models with cap (C) only.

Maximum absorption
D : 1.0 J [0.74 ft·lbf]
DE : 1.5 J [1.11 ft·lbf]

Body thread size
11 : M8×1

Piston dia.×absorbing stroke	Maximum absorption
4×4	B : 0.3 J [0.22 ft·lbf] BD : 0.5 J [0.37 ft·lbf]
5×5	D : 1.0 J [0.74 ft·lbf] DE : 1.5 J [1.11 ft·lbf]
6×8	DE : 1.5 J [1.11 ft·lbf] EF : 2.5 J [1.84 ft·lbf]
8×8	EF : 2.5 J [1.84 ft·lbf] G : 4.0 J [2.95 ft·lbf]
9×10	GK : 5.0 J [3.69 ft·lbf] L : 8.0 J [5.90 ft·lbf]
11×15	M : 10 J [7.4 ft·lbf] P : 15 J [11.1 ft·lbf]
14×16	R : 20 J [14.8 ft·lbf] T : 30 J [22.1 ft·lbf]
18×25	X : 40 J [29.5 ft·lbf]

Additional Parts

● Stopper nut

S - KSH - M



Thread size

6	: M6×0.75 (for CS-KSHC4×4)
8	: M8×0.75 (for CS-KSHC5×5)
8-11	: M8×1 (for CS-KSHC5×5-11)
10	: M10×1 (for CS-KSHC6×8)
12	: M12×1 (for CS-KSHC8×8)
14	: M14×1.5 (for CS-KSHC9×10)
16	: M16×1.5 (for CS-KSHC11×15)
20	: M20×1.5 (for CS-KSHC14×16)
25	: M25×1.5 (for CS-KSHC18×25)

● Hexagon nut (10 nuts in one bag)

N - KSH - M



Thread size

6	: M6×0.75 (for CS-KSHC4×4)
8	: M8×0.75 (for CS-KSHC5×5)
8-11	: M8×1 (for CS-KSHC5×5-11)
10	: M10×1 (for CS-KSHC6×8)
12	: M12×1 (for CS-KSHC8×8)
14	: M14×1.5 (for CS-KSHC9×10)
16	: M16×1.5 (for CS-KSHC11×15)
20	: M20×1.5 (for CS-KSHC14×16)
25	: M25×1.5 (for CS-KSHC18×25)

Mass

Model	Body mass	Additional mass (options)	
		g [oz.]	
		Stopper nut ^{Note}	With cap
CS-KSHC4×4	4.8 [0.169]	2 [0.07]	0.1 [0.004]
CS-KSHC5×5	9.2 [0.325]	4 [0.14]	0.3 [0.011]
CS-KSHC6×8	21 [0.74]	7 [0.25]	1 [0.04]
CS-KSHC8×8	32 [1.13]	8 [0.28]	1 [0.04]
CS-KSHC9×10	58 [2.05]	15 [0.53]	2 [0.07]
CS-KSHC11×15	94 [3.32]	29 [1.02]	2 [0.07]
CS-KSHC14×16	172 [6.07]	50 [1.76]	3 [0.11]
CS-KSHC18×25	350 [12.35]	100 [3.53]	7 [0.25]

Note: The stopper nut is an option available for models with cap (C) only.

Calculation sample: The mass of CS-KSHC6×8 with cap and stopper nut is 21+1+7=29 g [1.02 oz.]

Inner Construction, Major Parts and Materials

- CS-KSHC4×4
- CS-KSHC5×5

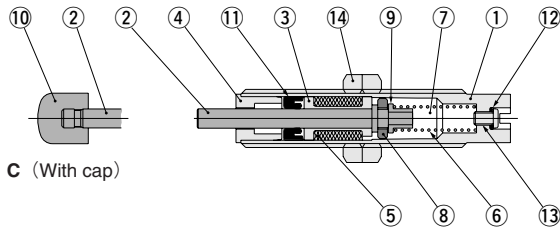

C (With cap)

- CS-KSHC6×8
- CS-KSHC8×8
- CS-KSHC9×10
- CS-KSHC11×15
- CS-KSHC14×16
- CS-KSHC18×25

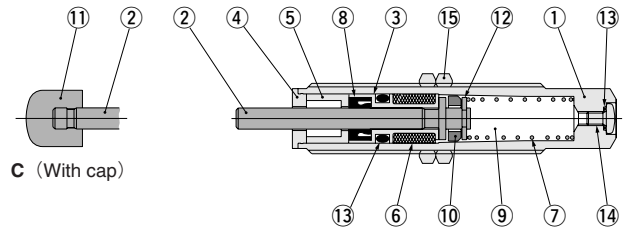

C (With cap)

Note : Part shapes vary somewhat between sizes.

- CS-KSHC4×4, 5×5

No.	Parts	Materials
①	Body	Copper alloy (nickel plated) [KSHC4: Steel (nickel plated)]
②	Piston rod	Steel (nickel plated)
③	Sleeve	Copper alloy
④	Plug	Stainless steel
⑤	Accumulator	Synthetic rubber (CR)
⑥	Spring	Spring steel
⑦	Oil	Special oil
⑧	Piston ring	Copper alloy
⑨	Collar	Copper alloy
⑩	Cap	Plastic (POM)
⑪	Rod seal	Synthetic rubber (NBR)
⑫	O-ring	Synthetic rubber (NBR)
⑬	Screw	Mild steel
⑭	Hexagon nut	Mild steel (nickel plated)

- CS-KSHC6×8, 8×8, 9×10, 11×15, 14×16, 18×25

No.	Parts	Materials
①	Body	Copper alloy (nickel plated)
②	Piston rod	Steel (nickel plated)
③	Sleeve	Copper alloy
④	Plug	Stainless steel
⑤	Spacer	Stainless steel
⑥	Accumulator	Synthetic rubber (CR)
⑦	Spring	Spring steel
⑧	Rod seal	Synthetic rubber (NBR)
⑨	Oil	Special oil
⑩	Piston ring	Copper alloy
⑪	Cap	Plastic (POM)
⑫	E-ring	Steel
⑬	O-ring	Synthetic rubber
⑭	Screw	Mild steel
⑮	Hexagon nut	Mild steel (nickel plated)

Dimensions mm [in.]

● No rod end cap: CS-KSHC4×4

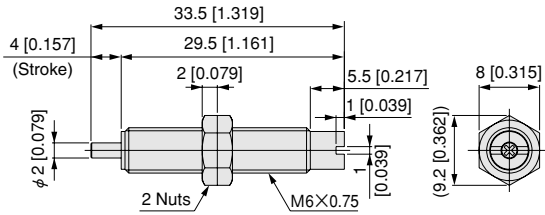

● With rod end cap: CS-KSHC4×4C

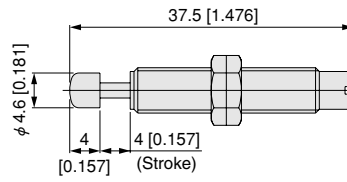

● No rod end cap: CS-KSHC5×5-11

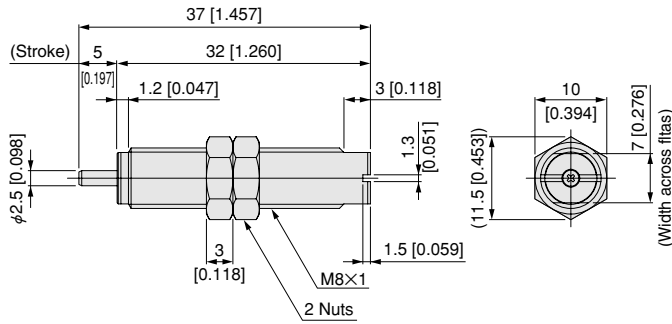

● With rod end cap: CS-KSHC5×5C-11

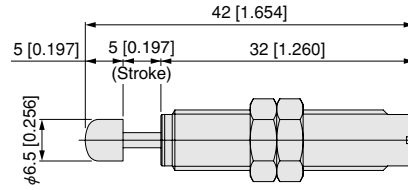

● No rod end cap: CS-KSHC□×□

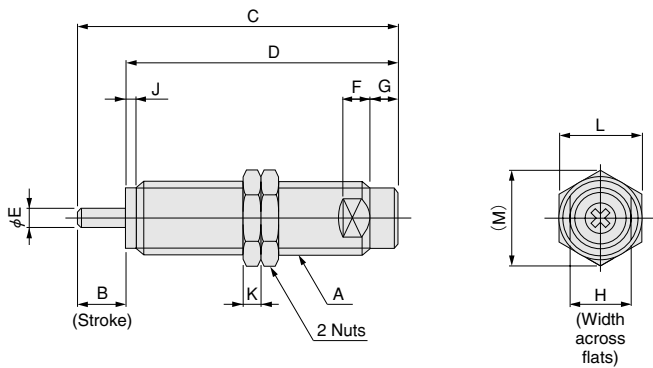

● With rod end cap: CS-KSHC□×□C

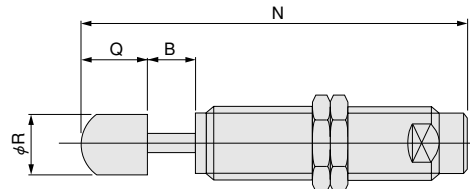

Model	Code	A	B	C	D	E	F	G	H	J	K	L	M	N	Q	R
CS-KSHC5×5□	M8×0.75	5 [0.197]	36 [1.417]	31 [1.220]	2.5 [0.098]	3 [0.118]	5 [0.197]	7 [0.276]	1.2 [0.047]	2 [0.079]	10 [0.394]	11.5 [0.453]	41 [1.614]	5 [0.197]	6.5 [0.256]	
CS-KSHC6×8□	M10×1	8 [0.315]	53 [2.087]	45 [1.772]	3 [0.118]	4 [0.157]	5 [0.197]	9 [0.354]	2 [0.079]	3 [0.118]	12 [0.472]	13.9 [0.547]	61 [2.402]	8 [0.315]	8 [0.315]	
CS-KSHC8×8□	M12×1	8 [0.315]	53 [2.087]	45 [1.772]	3 [0.118]	5 [0.197]	5.5 [0.217]	11 [0.433]	2 [0.079]	4 [0.157]	14 [0.551]	16.2 [0.638]	63 [2.480]	10 [0.394]	10 [0.394]	
CS-KSHC9×10□	M14×1.5	10 [0.394]	70 [2.756]	60 [2.362]	4 [0.157]	5 [0.197]	5.5 [0.217]	12 [0.472]	2 [0.079]	5 [0.197]	17 [0.669]	19.6 [0.772]	80 [3.150]	10 [0.394]	11 [0.433]	
CS-KSHC11×15□	M16×1.5	15 [0.591]	87 [3.425]	72 [2.835]	4 [0.157]	5 [0.197]	6 [0.236]	14 [0.551]	3 [0.118]	7 [0.276]	19 [0.748]	21.9 [0.862]	97 [3.819]	10 [0.394]	11 [0.433]	
CS-KSHC14×16□	M20×1.5	16 [0.630]	98 [3.858]	82 [3.228]	5 [0.197]	6 [0.236]	6 [0.236]	18 [0.709]	3 [0.118]	8 [0.315]	24 [0.945]	27.7 [1.091]	113 [4.449]	15 [0.591]	15 [0.591]	
CS-KSHC18×25□	M25×1.5	25 [0.984]	135 [5.315]	110 [4.331]	6 [0.236]	7 [0.276]	6 [0.236]	23 [0.906]	3 [0.118]	10 [0.394]	30 [1.181]	34.6 [1.362]	153 [6.024]	18 [0.709]	18 [0.709]	

Dimensions of Additional Parts mm [in.]

● Stopper nut: S-KSH-□-□ (-S)

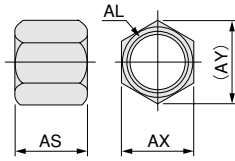

Model	Code	AL	AS	AX	AY
S-KSH-M6	M6×0.75	7 [0.276]	8 [0.315]	8 [0.315]	9.2 [0.362]
S-KSH-M8	M8×0.75	11 [0.433]	10 [0.394]	10 [0.394]	11.5 [0.453]
S-KSH-M8-11	M8×1	11 [0.433]	10 [0.394]	10 [0.394]	11.5 [0.453]
S-KSH-M10	M10×1	17 [0.669]	12 [0.472]	12 [0.472]	13.9 [0.547]
S-KSH-M12	M12×1	17 [0.669]	14 [0.551]	14 [0.551]	16.2 [0.638]
S-KSH-M14	M14×1.5	18 [0.709]	17 [0.669]	17 [0.669]	19.6 [0.772]
S-KSH-M16	M16×1.5	30 [1.181]	19 [0.748]	19 [0.748]	21.9 [0.862]
S-KSH-M20	M20×1.5	35 [1.378]	24 [0.945]	24 [0.945]	27.7 [1.091]
S-KSH-M25	M25×1.5	40 [1.575]	30 [1.181]	30 [1.181]	34.6 [1.362]

● Hexagon nut: N-KSH-□-□

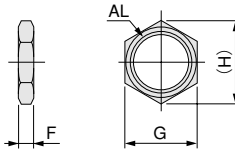

Model	Code	AL	F	G	H
N-KSH-M6	M6×0.75	2 [0.079]	8 [0.315]	8 [0.315]	9.2 [0.362]
N-KSH-M8	M8×0.75	2 [0.079]	10 [0.394]	10 [0.394]	11.5 [0.453]
N-KSH-M8-11	M8×1	3 [0.118]	10 [0.394]	10 [0.394]	11.5 [0.453]
N-KSH-M10	M10×1	3 [0.118]	12 [0.472]	12 [0.472]	13.9 [0.547]
N-KSH-M12	M12×1	4 [0.157]	14 [0.551]	14 [0.551]	16.2 [0.638]
N-KSH-M14	M14×1.5	5 [0.197]	17 [0.669]	17 [0.669]	19.6 [0.772]
N-KSH-M16	M16×1.5	7 [0.276]	19 [0.748]	19 [0.748]	21.9 [0.862]
N-KSH-M20	M20×1.5	8 [0.315]	24 [0.945]	24 [0.945]	27.7 [1.091]
N-KSH-M25	M25×1.5	10 [0.394]	30 [1.181]	30 [1.181]	34.6 [1.362]

Evaluation of Cleanliness (Shock Absorber KSHC Series)

There is currently no standard in JIS or elsewhere for methods of evaluating shock absorber's cleanliness. Koganei has therefore independently established our in-house measurement methods, to conduct the cleanliness evaluations.

● Measurement method

1. Measure particles in the clean bench (Figure 1) without activating the measurement use shock absorber and load driving cylinder in the clean bench (to measure the background valve).^{Note}

Note : Under the background measurement condition, the number of particles measures zero.

2. Drive the load and activate the shock absorber under the measurement condition, to measure the particles.

● Measurement conditions

- Load impact speed : 300 mm/s [11.8 in./sec.]
- Shock absorber operating frequency : 30 cycle/min^{Note 1}
- Particle measurement time : 1 minute
- Suction rate : 1 cf/min
- Measured particles : 0.1 μm and larger

For reference, a graph of actual values is shown in Figure 2.

The number of particles is the average value of the test samples. Also, the smaller the angle variation of eccentricity when mounting the shock absorber, the lower the number of particles is likely to be. Mount the shock absorber so that its angle of eccentricity to the workpiece is as small as possible.

- Notes: 1. The number of particles is based on 30 operation cycles. The customer's evaluation should be based on the customer's own operation frequency.
 2. Corresponds to FED-STD Class1.
 3. The number of particles in the graph are actual values measured under Koganei standards, and are not intended to be guaranteed values.

● Outline of particle measuring device

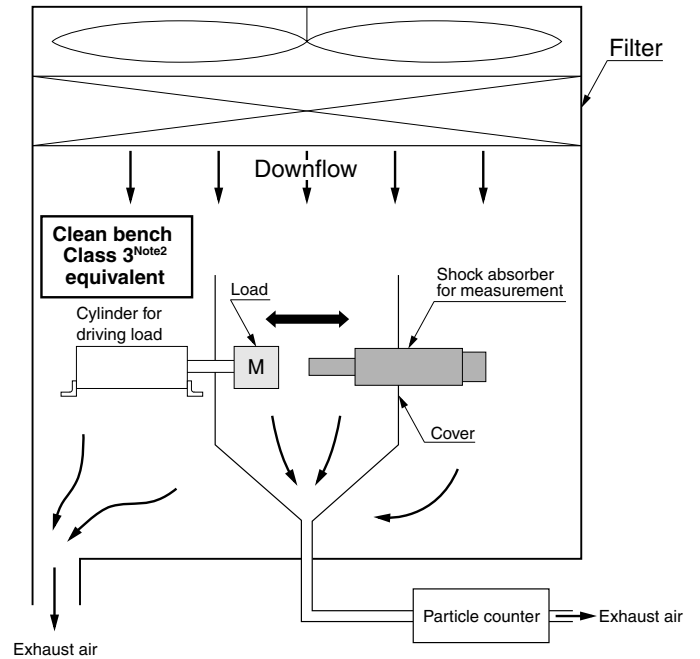

Figure 1

● Number of particles (measured value) ^{Note 3}

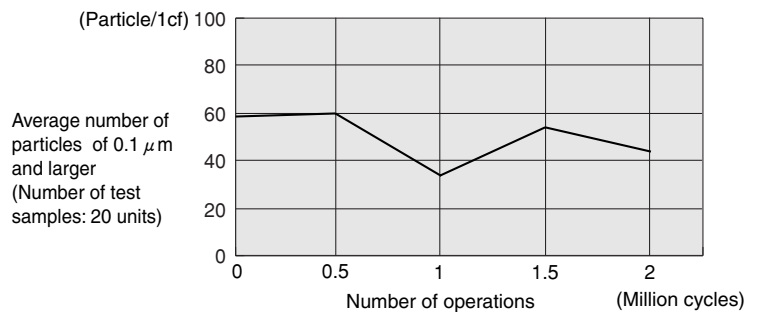

Figure 2