



## Compact 2- and 3-Port Valves for Chemical Solutions

# PVS series



KOGANEI brand

All products are **RoHS-Compliant**

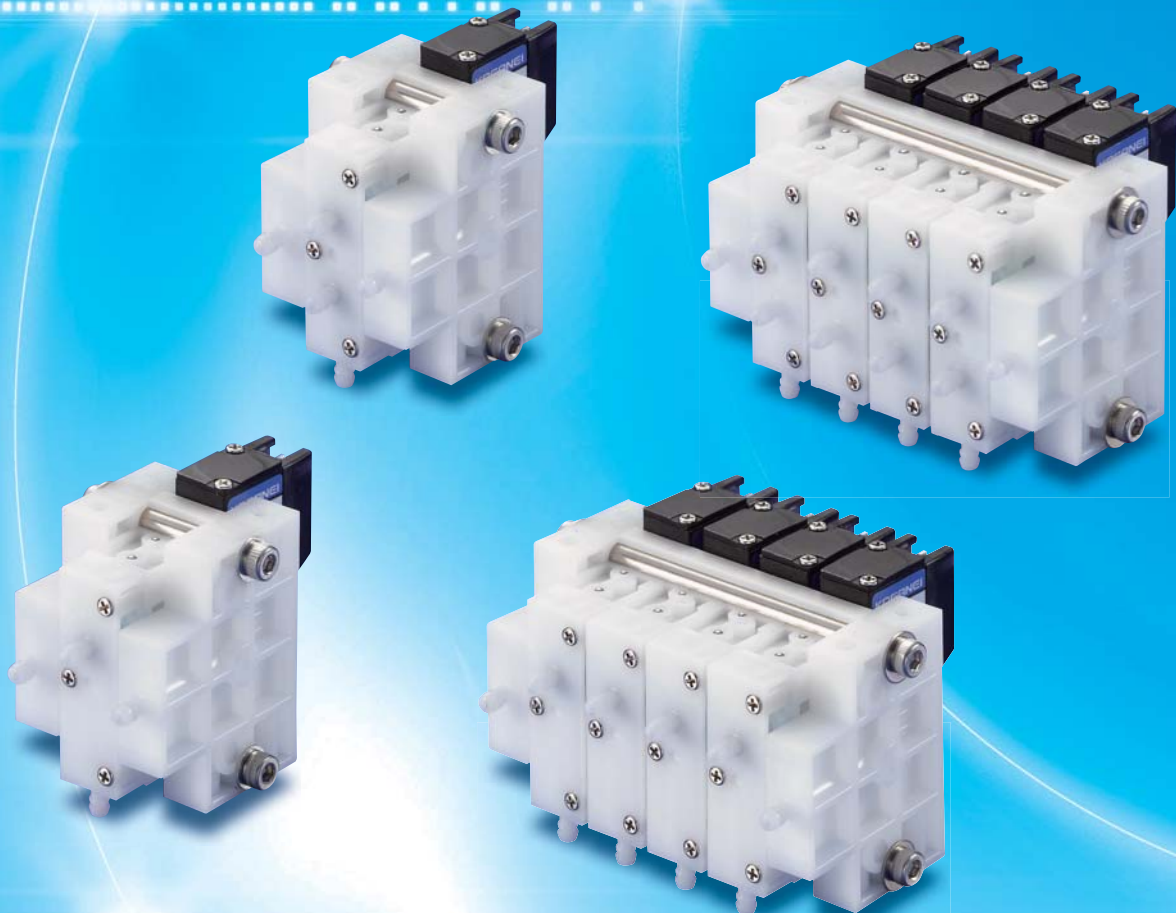

- 12 mm width indirect acting solenoid valves for chemical solutions
- Synchronous operation of up to two air operated valves by one solenoid valve!

# Compact valves for chemical solutions

## PVS series

- 1.5 mm orifice diameter and 12 mm width indirect acting 2- and 3-port solenoid valves for chemical solutions
- Best suited for dispensing process of analyzers
- Designed with consideration given to a flow in a valve chamber
- Indirect acting valves adopted not to transfer heat to media
- Free combination of manifolds (Up to 20 valves can be mounted)

### Synchronous Operation of up to Two Air Operated Valves by One Solenoid Valve!

Up to two air operated valves can perform synchronous operation by one solenoid valve. The design of electric control becomes simpler and power consumption can be reduced.

#### Example 1

Solenoid valves

Operate individually

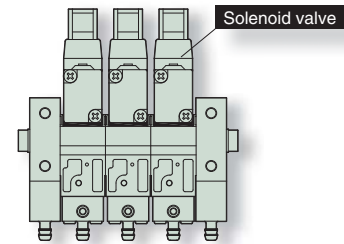

#### Example 2

One solenoid valve and  
one air operated valve

Operate simultaneously

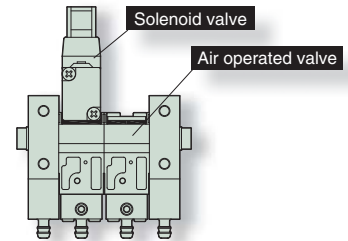

#### Example 3

One solenoid valve and  
two air operated valves

Operate simultaneously

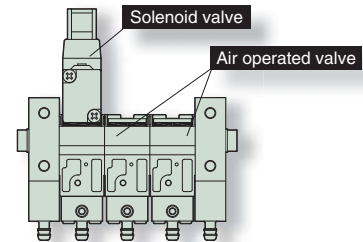

### Application Examples

#### Dispensing process of analyzer (2-port valve)

Up to two air operated valves can perform synchronous operation by one solenoid valve.

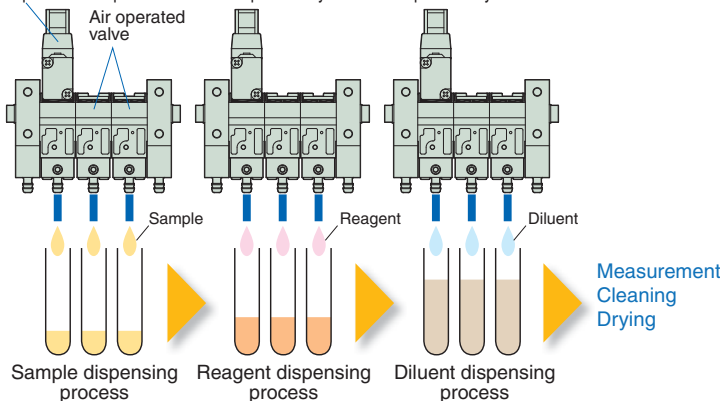

#### Cleaning process or others (2-port valve)

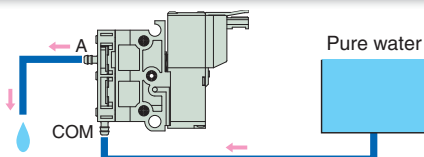

#### Switching two types of solutions (3-port valve)

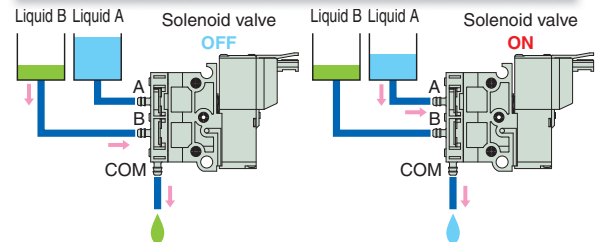

#### Dividing into two types of containers (3-port valve)

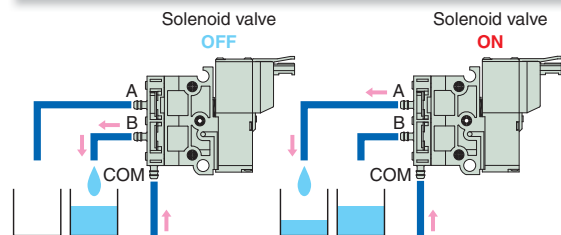

**CAUTION** Before use, be sure to read "Safety Precautions" on Page 5.

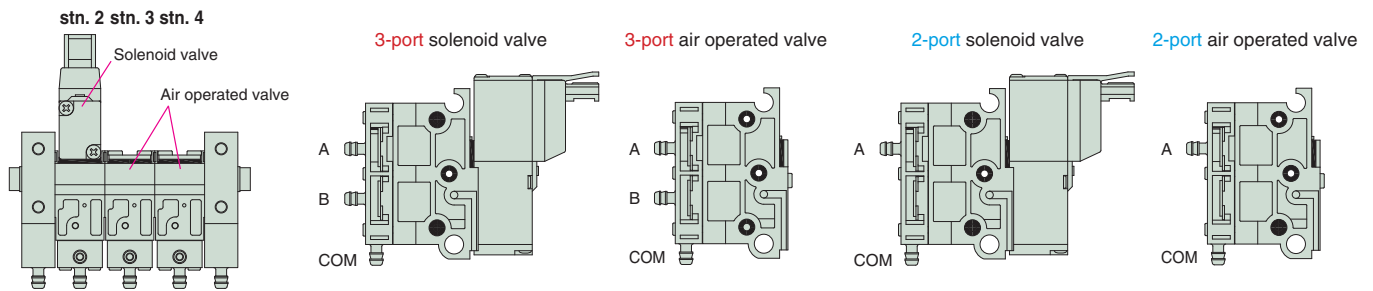

## Combination Examples of Synchronously Operable "Solenoid Valve" and "Air Operated Valves"

<Synchronous operation> of two valves on stn. 2 and stn. 3 or three valves on stn. 2, stn. 3 and stn. 4 is available.

	Synchronous operation	Combination	Model	Flow when solenoid valve is ON	Flow when solenoid valve is OFF
1	○	stn. 2: 3-port solenoid valve	PVS3-E1-015-111	Flow between A ↔ COM	Flow between B ↔ COM
		stn. 3: 3-port air operated valve	PVS3-015-111	Flow between A ↔ COM	Flow between B ↔ COM
		stn. 4: 3-port air operated valve	PVS3-015-111	Flow between A ↔ COM	Flow between B ↔ COM
2	○	stn. 2: 3-port solenoid valve	PVS3-E1-015-111	Flow between A ↔ COM	Flow between B ↔ COM
		stn. 3: 3-port air operated valve	PVS3-015-111	Flow between A ↔ COM	Flow between B ↔ COM
		stn. 4: 2-port air operated valve	PVS2-015-111	Flow between A ↔ COM	No flow
3	○	stn. 2: 3-port solenoid valve	PVS3-E1-015-111	Flow between A ↔ COM	Flow between B ↔ COM
		stn. 3: 2-port air operated valve	PVS2-015-111	Flow between A ↔ COM	No flow
		stn. 4: 2-port air operated valve	PVS2-015-111	Flow between A ↔ COM	No flow
4	○	stn. 2: 2-port solenoid valve	PVS2-E1-015-111	Flow between A ↔ COM	No flow
		stn. 3: 2-port air operated valve	PVS2-015-111	Flow between A ↔ COM	No flow
		stn. 4: 2-port air operated valve	PVS2-015-111	Flow between A ↔ COM	No flow

## Combination Examples of Synchronously Inoperable "Solenoid Valve" and "Air Operated Valves"

(1) Operation sequence of valves from "2-port" to "3-port" cannot be used.

	Synchronous operation	Combination	Model
1	×	stn. 2: 3-port solenoid valve	PVS3-E1-015-111
		stn. 3: 2-port air operated valve	PVS2-015-111
		stn. 4: 3-port air operated valve	PVS3-015-111
2	×	stn. 2: 2-port solenoid valve	PVS2-E1-015-111
		stn. 3: 3-port air operated valve	PVS3-015-111
		stn. 4: 3-port air operated valve	PVS3-015-111
3	×	stn. 2: 2-port solenoid valve	PVS2-E1-015-111
		stn. 3: 3-port air operated valve	PVS3-015-111
		stn. 4: 2-port air operated valve	PVS2-015-111
4	×	stn. 2: 2-port solenoid valve	PVS2-E1-015-111
		stn. 3: 3-port air operated valve	PVS3-015-111

(2) "Air operated valves" cannot be mounted on a station whose number is lower than that a "solenoid valve" is mounted on.

	Synchronous operation	Combination	Model
1	×	stn. 2: 3-port air operated valve	PVS3-015-111
		stn. 3: 3-port solenoid valve	PVS3-E1-015-111
2	×	stn. 2: 2-port air operated valve	PVS2-015-111
		stn. 3: 2-port solenoid valve	PVS2-E1-015-111

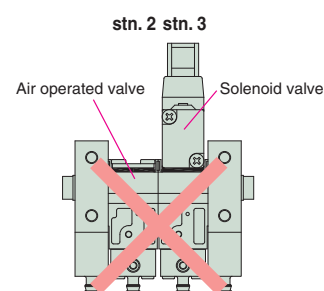

## Handling Instructions and Precautions

### Ports that pilot air cannot be supplied to

Air cannot be supplied to the pilot port of the last station that bears a product label.  
Do not connect piping.

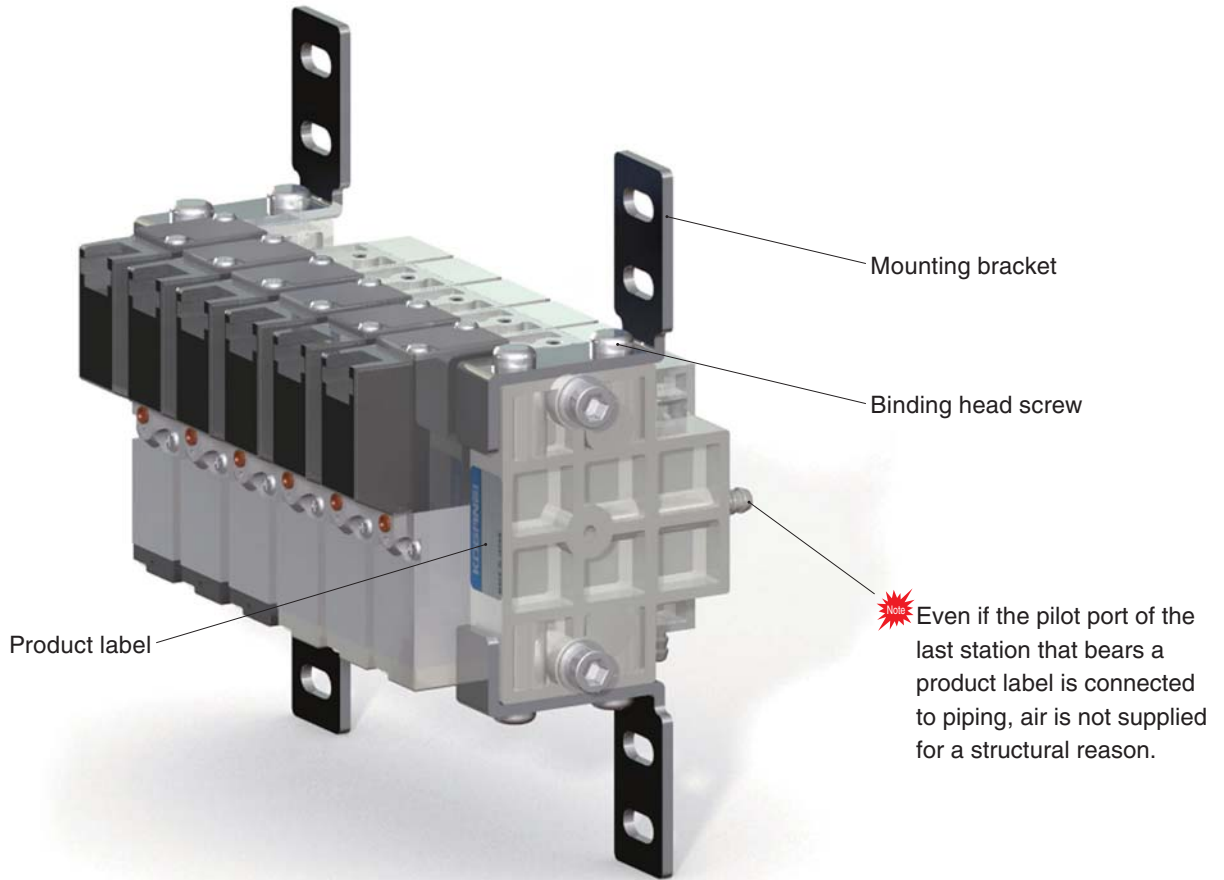

### About mounting direction

Regarding valve mounting direction, consider the liquid accumulation of media and mount in the direction shown below.



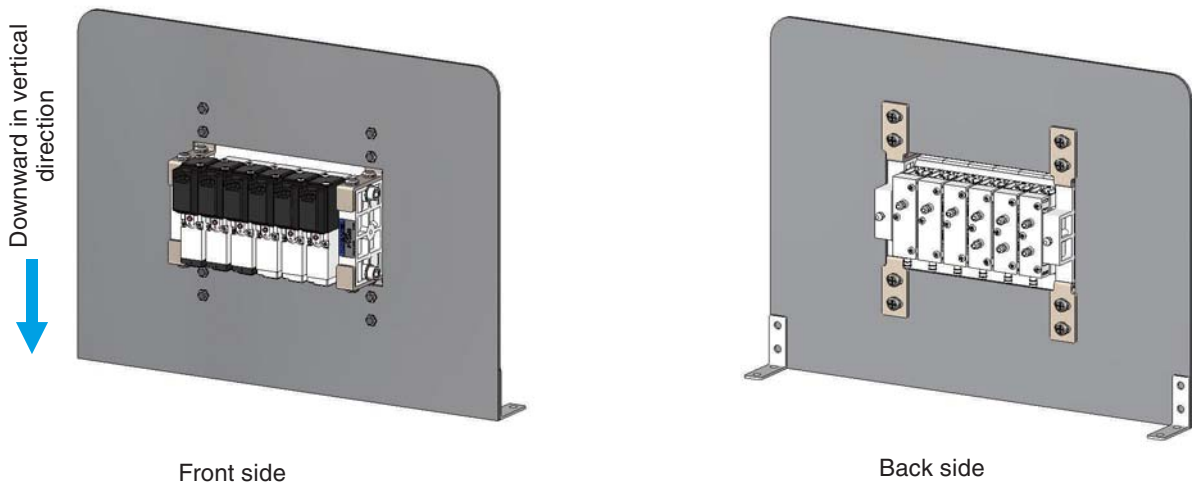

#### Sheet-metal mounting example





Before selecting and using the products, please read all safety precautions carefully to ensure proper product use. The safety precautions described below are to help you use the product safely and correctly, and to prevent injury or damage to you, other people, and assets. Always adhere to the following safety regulations: ISO4414 (Pneumatic fluid power - General rules and safety requirements for systems and their components) and JIS B 8370 (General rules relating to pneumatic systems).

Items are ranked as follows according to degree of potential danger or damage: "DANGER", "WARNING", "CAUTION", and "ATTENTION".

 <b>DANGER</b>	Indicates situations that can be clearly predicted as dangerous. Failure to avoid the situation creates the risk of death or serious injury. It could also result in damage or destruction of assets.
 <b>WARNING</b>	Indicates situations that, while not immediately dangerous, could become dangerous. Failure to avoid the situation creates the risk of death or serious injury. It could also result in damage or destruction of assets.
 <b>CAUTION</b>	Indicates situations that, while not immediately dangerous, could become dangerous. Failure to avoid the situation creates the risk of minor or semi-serious injury. It could also result in damage or destruction of assets.
 <b>ATTENTION</b>	While there is little chance of injury, this content refers to points that should be observed for appropriate use of the product.

**■ This product was designed and manufactured for use in specific analyzers.**

- When selecting and handling compact valves for chemical solutions, the system designer or another person with sufficient knowledge and experience should always read the safety precautions, catalog, instruction manual and other literature before commencing operation. Improper handling is dangerous.
- After reading the catalog, instruction manual, etc., always keep them in a location where they are readily available for reference to users of this product.
- If transferring or lending the product to another person, always attach the catalog, instruction manual, etc., to the product where they are easily visible, to ensure that the new user can use the product safely and properly.
- The danger, warning and caution items listed under these safety precautions do not cover all possible contingencies. Read the catalog and instruction manual carefully, and always keep safety first.

 **DANGER**

- Do not use the product for the purposes listed below:
  1. Medical devices and instruments used to support and manage human life and bodies.
  2. Uses for connecting directly to human bodies through devices and uses to be suspected to affect human life significantly.
  3. Machines or equipment designed for the purpose of moving or transporting people.
  4. Critical safety components in mechanical devices.
  5. Devices directly supplying food and drink.
 This product has not been planned, designed, or manufactured for purposes that require high levels of safety. Using the product in any of the ways described above creates the risk of loss of human life and body, or property.
- Do not use this product in locations with or near dangerous substances such as flammable or ignitable substances. Do not flow flammable gas or flammable chemical solutions into the product. This product is not explosion-proof. Doing so creates the risk of ignition and fire.
- Persons using a pacemaker or other similar medical devices should maintain a distance of at least one meter away from the solenoid valves. Getting too close to the product creates the risk of malfunction of a pacemaker due to the strong magnet built into the solenoid valves.
- When using solutions (chemicals), be sure to check the suitability for components of this product before use. Using unsuitable media could lead to loss of function in a short period of time, sudden degradation of performance, or a reduced operating life. The media may leak outside and some media may create the risk of loss of human life.
- When mounting the product and tubes, always make sure they are firmly supported and secured in place. Falling, dropping, or abnormal operation of the product creates the risk of personal injury.
- While the product is in operation, avoid touching it with your hands or approaching too close. Also, do not attempt to make any adjustments to internal or attached mechanism, or to perform any type of adjustment (manual override, attachment/removal of wiring connectors, disconnecting piping tubes or sealed plugs, adjustment of the product mounting position, etc.) while the product is in operation. Chemical solutions or other media may flow out and create the risk of personal injury.
- Do not splash water on the product. Spraying it with water, washing it, or using it under water could result in malfunction of the product leading to injury, electric shock, fire, etc.
- Never attempt to modify the product. Abnormal operation can lead to injury, etc.
- Never attempt inappropriate disassembly, assembly or repair of the product relating to basic construction, or to its performance or to functions. Doing so creates the risk of injury, electric shock, fire, etc.

 **WARNING**

- Because Koganei products are designed for use under a wide variety of conditions, decisions concerning conformance with a particular system should be made upon the careful evaluation by the person in charge of system design. Assurances concerning expected system performance and safety are the responsibility of the designer who decides system conformity. Be sure to use the latest catalogs and technical materials to study and evaluate specification details, to consider the possibility of machine breakdown, and to configure a system that ensures fail-safe safety and reliability.
- Do not use hydrochloric acid, hydrofluoric acid, or nitric acid.
- The media to use are air, water, and solutions that do not affect the product components. Do not use other media because such use could lead to degradation of performance, a reduced operating life, and loss of function. Use corrosive or toxic media under the responsibility of personnel in charge of system design.
- Do not use the product in excess of its specification ranges. Doing so creates the risk of product breakdown, loss of function, or damage. It could also drastically reduce operating life.
- Check piping before supplying chemical solutions or pilot air to the product and before operating the product. If supplying chemical solutions or pilot air inadvertently, they may flow into unintended portions or leak, and it creates the risk of personal injury.
- Before conducting maintenance, inspection, repair, replacement, or any other similar procedure of the product (especially when a solution in use is a chemical solution), confirm that no chemical solutions remain in the device, that pilot air is shut off, and that no pressure remains in piping. Failure to do so may flow chemical solutions or other solutions, and it creates the risk of personal injury.
- After installing fittings or tubes, make sure to perform leak tests before flowing chemical solutions or other solutions and check the product for leakage. Failure to do so may leak chemical solutions or other solutions and creates the risk of personal injury.
- Do not pull tubes connected to fittings. Tubes may come off and chemical solutions or air may leak.
- When using fittings and tubes, make sure to use screws and tubes of the suitable size. If using an unsuitable part, it could lead to leakage or tubes may come off.
- Always check the catalog and other reference materials for correct solenoid valve wiring and piping. Improper wiring and piping create the risk of damage and abnormal operation of the product, etc.
- Do not locate the solenoid valve and the wiring that controls the valve near power lines running a large current, powerful magnetic fields, or where power surge occurs. Doing so could cause erratic operation.
- Do not mount solenoid valves in a control board. Leakage from piping or other parts may occur due to heat or others in the control board.

- When the energization time of the solenoid valves is long, take thermal dissipation measures to keep the ambient temperature within the temperature range in the specifications at all times. Moreover, for long-term continuous energization, consult us.
- The solenoid valves generate surge voltage and electromagnetic wave when the valve becomes OFF, and it could affect performance of peripheral devices. Take measures against surge suppression and electromagnetic wave for the electric circuit.
- Before performing any kind of wiring work of the solenoid valves, be sure to turn off power. Failure to do so creates the risk of electric shock.
- After completing wiring work of the solenoid valves, check to make sure that all connections are correct before turning on power.
- Apply the specified voltage properly to the solenoid of the solenoid valves. Application of incorrect voltage may prevent the functions from working properly and cause the product to be damaged or burned out.
- Do not damage lead wires of the solenoid valves. Allowing a lead wire to become damaged, bent excessively, pulled, rolled up, or squeezed between two objects creates the risk of current leaks or defective continuity that can lead to fire, electric shock, abnormal operation, or others.
- Do not connect or disconnect connectors while power is turned on. Also, never apply unnecessary force to connectors. Doing so creates the risk of personal injury, device damage, and electric shock due to abnormal machine operation.
- Do not touch terminals or switches while power of the solenoid valves is turned on. Doing so creates the risk of electric shock and abnormal operation.
- Design a system that ensures safety and prevents damage to machinery and personal injury when the machine is shut down due to an emergency stop or electrical power failure.
- When the machine has been idle for over 48 hours or is in first operation after storage, make sure to check before commencement of operation and to perform a test operation. Sliding parts of components may have stuck after a long time without operation, and it could lead to operation delays or sudden movements of the device.
- When the device is not used for long periods (over 30 days), it is possible that the contacting parts may have become stuck leading to slow operation or sudden movements. Check for proper operation a minimum of once every 30 days.
- Do not sit on the product, place your foot on it, or place other objects on it. Doing so creates the risk of injury due to tripping or the product tipping over or dropping, resulting in product damage and abnormal, erratic, or runaway operation.
- Do not allow the product to be thrown into fire. Doing so creates the risk of explosion and the release of toxic gases.

## CAUTION

- Do not use the product in locations that are subject to direct sunlight (ultraviolet rays) or in locations with high humidity and temperature, dust, salt, or iron powder. Do not use the product when media or atmosphere include unsuitable elements for components. It could lead to early shutdown of some functions, a sudden degradation of performance, and a reduced operating life. For details on part materials, refer to material and usable media in Order Codes.
- The product is not waterproof. Do not use the product subject to dripping water, dripping chemical solutions, and others.
- When mounting the product, leave room for adequate working space around it. Failure to do so will make it more difficult to conduct daily inspections or maintenance, which could eventually lead to system shutdown or damage to the product.
- Always post an "operations in progress" sign for installations, adjustments, or other operations to avoid unintentional supplying of chemical solutions, pilot air, electrical power, or others. Unintentional supplying of chemical solutions, pilot air, electrical power, and others could lead to sudden operation or electric shock and may result in personal injury.
- Do not use a solenoid valve in locations subject to large electrical currents or strong magnetic fields. Doing so could result in erratic operation.
- Do not bring any magnetic media or memory media, or other similar items within one meter of an energized solenoid valve. Doing so creates the risk of damage to data on the magnetic media due to magnetism.
- Leakage current occurred in the control circuit of the solenoid valves could lead to unintended operation of the products. Be sure to take a countermeasure against the leakage current to the control circuit so that the current may not exceed the allowable current value specified for respective products.
- Do not clog breathing holes on the products. Pressure fluctuation occurs due to a volume change during operation. Clogging the breathing hole prevents pressure balancing and intended operation and could lead to a damaged device or personal injury.
- Oil from the compressor could lead to significant degradation of performance of the solenoid valves or a reduced operating life.

Make sure to install an air cleaning device such as a mist filter for oil removal on the primary side.

- Use of extremely dry air whose dew-point temperature exceeds -20° C may affect the quality of the lubricating oil used. This creates the risk of degraded performance, loss of function, or other problems.

## ATTENTION

- When considering the possibility of using this product in situations or environments not specifically noted in the catalog or instruction manual, or in applications where safety is an important requirement such as in aircraft equipment, combustion equipment, leisure equipment, safety equipment, and other places where human life or assets may be greatly affected, take adequate safety precautions such as allowing plenty of margin for ratings and performance, or fail-safe measures. Contact the sales department at Koganei regarding use in such applications.
- Perform a chemical-resistant evaluation test of wetted components to media to use in advance.
- Always check the catalog and other reference materials for product wiring and piping.
- Moving parts of the machine and devices should be isolated with a protection cover so as not to be directly contacted by human body.
- When handling the product, wear protective gloves, safety glasses, safety shoes, and other protective clothing.
- When the product can no longer be used or is no longer necessary, dispose of it appropriately as industrial waste.
- The compact valves for chemical solutions can exhibit degraded performance and function over its operating life. Always conduct daily inspections and confirm that all requisite system functions are satisfied to prevent accidents from happening.
- Before installation, a consultation about details on use conditions and environmental conditions is required. Be sure to contact KOGANEI. For inquiries, consult your nearest KOGANEI sales office or KOGANEI overseas department. The addresses and telephone numbers are shown on the back cover of this catalog.

## Other precautions

- Always observe the following items.
  1. When using this product in fluid systems or pneumatic systems for pilot air, always use genuine Koganei parts or compatible parts (recommended parts).  
When conducting maintenance and repairs, always use genuine Koganei parts or equivalent parts (recommended parts). Always observe the prescribed methods and procedures.
  2. Never attempt inappropriate disassembly or assembly of the product relating to basic configurations, or its performance or functions.

Koganei shall not be held responsible for any problems that occur as a result of these items not being properly observed.

## Warranty and General Disclaimer

### 1. Warranty Period

Koganei warrants this product for a period of no more than 180 days from the date of delivery.

### 2. Scope of Warranty and General Disclaimer

- (1) The Koganei product warranty covers individual products. When a product purchased from Koganei or from an authorized Koganei distributor malfunctions during the warranty period in a way that is attributable to Koganei's responsibility, Koganei will repair or replace the product free of charge. Even if a product is still within the warranty period, its durability is determined by its operation cycles and other factors. Contact your nearest Koganei sales office or the Koganei overseas department for details.
- (2) Koganei shall not be held responsible for any losses or for any damage to other machinery caused by breakdown, loss of function, or loss of performance of Koganei products.
- (3) Koganei shall not be held responsible for any losses due to use or storage of the product in a way that is outside of the product specifications prescribed in Koganei catalogs and the instruction manual, and/or due to actions that violate the mounting, installation, adjustment, maintenance and other safety precautions.
- (4) Koganei shall not be held responsible for any losses caused by breakdown of the product due to factors outside the responsibility of Koganei, including but not limited to fire, natural disaster, the actions of third parties, and intentional actions or errors by you.

# Specifications

Item	Model	PVS2	PVS2-E1	PVS3	PVS3-E1
Valve		Air operated valve	Solenoid valve	Air operated valve	Solenoid valve
Numbers of positions and ports		2-position, 2-port valve		2-position, 3-port valve	
Operation method		Air pilot			
Valve function		Normally closed		Universal	
Media		Air, water, pure water, and chemical solution <sup>Note 1</sup>			
Orifice diameter	mm	φ1.5			
Port size		φ3.2 nipple (POM), M6×1 female thread			
Operating pressure range	MPa	A/B ↔ COM : -0.054 to 0.2			
Proof pressure	MPa	0.3			
Pilot operating pressure	MPa	0.15 to 0.3			
Pilot proof pressure	MPa	0.4			
Leakage (at diaphragm portion)	cm <sup>3</sup> /min	0 for both internally and externally			
Operating temperature range	°C	5 to 45			
Operating media temperature range	°C	5 to 45 (non-condensation)			
Operating frequency	Hz	2			
Rated voltage		—	12VDC/24VDC (5VDC/6VDC) <sup>Note 2</sup>	—	12VDC/24VDC (5VDC/6VDC) <sup>Note 2</sup>
Operating voltage range	V	—	Rated voltage ± 10%	—	Rated voltage ± 10%
Power consumption	W	—	1.2	—	1.2

Note 1: Perform a chemical-resistant evaluation test of the product wetted components to media to use in advance.

2: 5VDC and 6VDC are made-to-order products.

Remark 1: This solenoid valve is not waterproof. Keep water and reagents away from the lead wire assembly portion. Failure to do so may cause a short circuit or damage the solenoid valve.

2: Take water hammer into consideration and set the product not to exceed the operating pressure.

3: An order of valve alone is not accepted. Order as unit models.

\*Before installation, a consultation about details on application conditions and environmental conditions is required. Be sure to contact KOGANEI. For inquiries, consult your nearest KOGANEI sales office or KOGANEI overseas department. The addresses and telephone numbers are shown on the back cover of this catalog.

## Internal circuit

**Solenoid with LED indicator (surge suppression provided)**

**Order code: -PSL, -PLL**

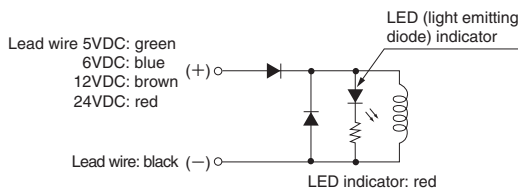

# Order Codes

## 1. Unit models

Unit model		Station	Basic model	Wiring	EC
PVSM	03 • • •	stn. 1	PVSP-01		
		stn. □	PVS2-E1-015-□□□	-PLL	12VDC, 24VDC
			PVS3-E1-015-□□□	-PSL	(5VDC, 6VDC)
	PVS2-015-□□□				
	(1)		PVSP-03		
			PVSP-04		

### (1) Number of units

PVSP-01 (pilot supply port) is mounted on stn. 1 and PVSP-04 is mounted on the last station for 3 to 23 units. The pilot supply port PVSP-03 should be mounted at the midpoint position for 12 or more units. 13 units are not available.

### (2) Station numbers of pilot supply ports

Number of units	3~12	14, 15	16, 17	18, 19	20, 21	22, 23
Station	stn. 1	stn. 1 and stn. 8	stn. 1 and stn. 9	stn. 1 and stn. 10	stn. 1 and stn. 11	stn. 1 and stn. 12

Remark 1: 5VDC and 6VDC are made-to-order products.

- 2: For combination of "solenoid valve" and "air operated valves", "air operated valves" cannot be mounted on a station whose number is lower than that of a mounted "solenoid valve".
- 3: An "air operated valve" does not operate by itself.
- 4: Up to two "air operated valves" can perform synchronous operation by one "solenoid valve".

## 2. Mounted valve models

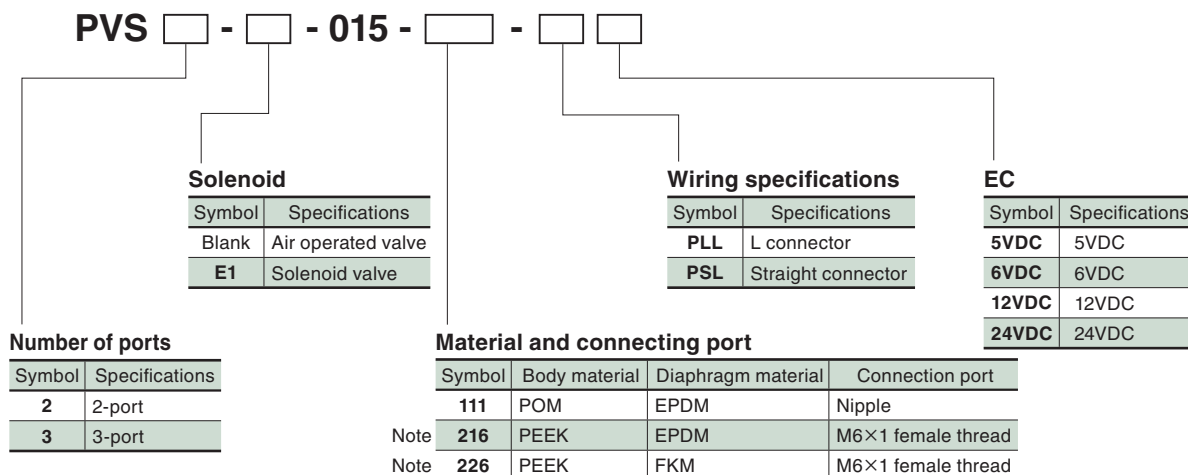

Note: For operating conditions and ordering procedures, you will need to consult with Koganei. Contact your nearest Koganei sales office. (Special specifications)

Remark 1: For inquiries about other body materials, diaphragm materials, connecting ports, and wiring specifications, contact your nearest KOGANEI sales office.

2: 5VDC and 6VDC are made-to-order products.

### Material and usable media

Combination	Body material	Diaphragm material	Usable media
1	POM	EPDM	Pure water, physiological saline, water-soluble ink, methanol or, cleaning solution (sodium hypochlorite solution (available chlorine concentration 1 w/v%))
2	PEEK	EPDM	Cleaning solution, ethylene glycol, acetylene, or acetone
3	PEEK	FKM	Cleaning solution or alcohol



## Dimensions (mm)

### Mounting example

#### PVSM12

- stn. 1 PVSP-01
- stn. 2-6 PVS3-E1-015-111-PLL 24VDC
- stn. 7-11 PVS2-E1-015-111-PLL 24VDC
- stn. 12 PVSP-04

- Notes 1: Perform a chemical-resistant evaluation test of the product wetted components to media to use in advance.
- 2: The pilot port air of **stn. 1** is for valve operation of **stn. 2-11**.

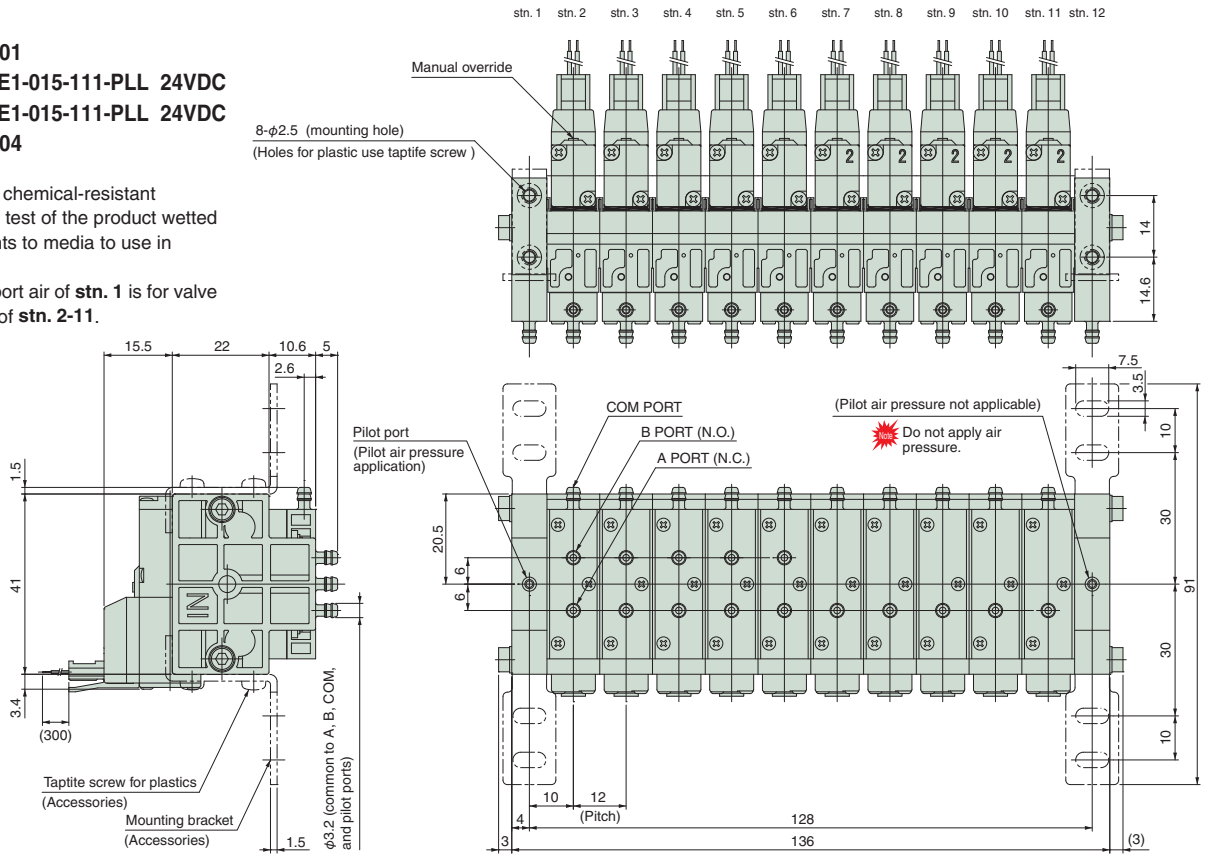

### Mounting example

#### PVSM14

- stn. 1 PVSP-01
- stn. 2-6 PVS3-E1-015-111-PLL 24VDC
- stn. 7 PVS2-015-111
- stn. 8 PVSP-03
- stn. 9-12 PVS2-E1-015-111-PLL 24VDC
- stn. 13 PVS2-015-111
- stn. 14 PVSP-04

- Notes 1: Perform a chemical-resistant evaluation test of the product wetted components to media to use in advance.
- 2: The pilot port air of **stn. 1** is for valve operation of **stn. 2-7** and the pilot port air of **stn. 8** is for valve operation of **stn. 9-13**.

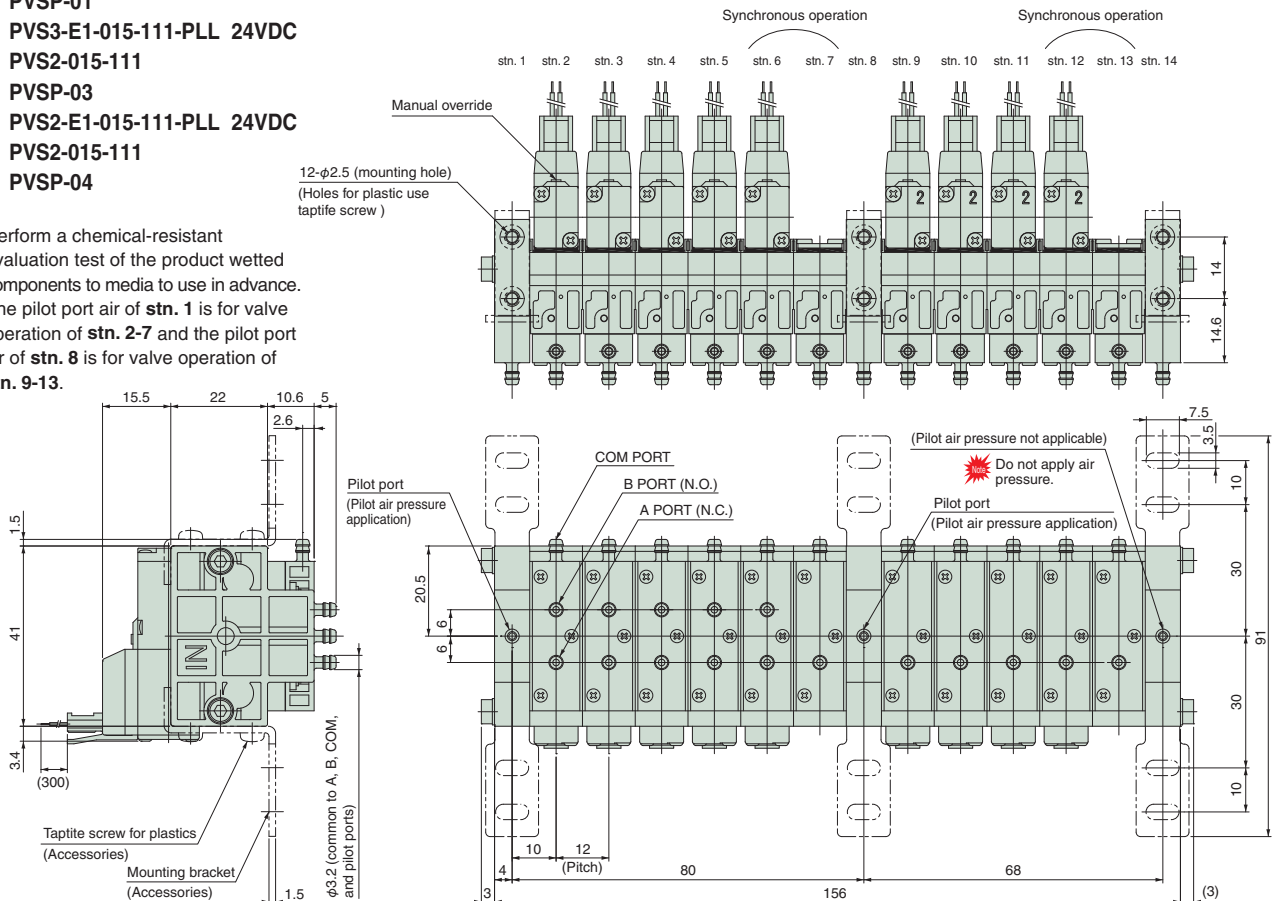

Mounting example

PVSM12

- stn. 1 PVSP-01
- stn. 2-6 PVS3-E1-015-226-PLL 24VDC
- stn. 7-11 PVS2-E1-015-226-PLL 24VDC
- stn. 12 PVSP-04

- Notes 1: Perform a chemical-resistant evaluation test of the product wetted components to media to use in advance.
- 2: The pilot port air of **stn. 1** is for valve operation of **stn. 2-11**.
- 3: This installation example is the case of special specifications.

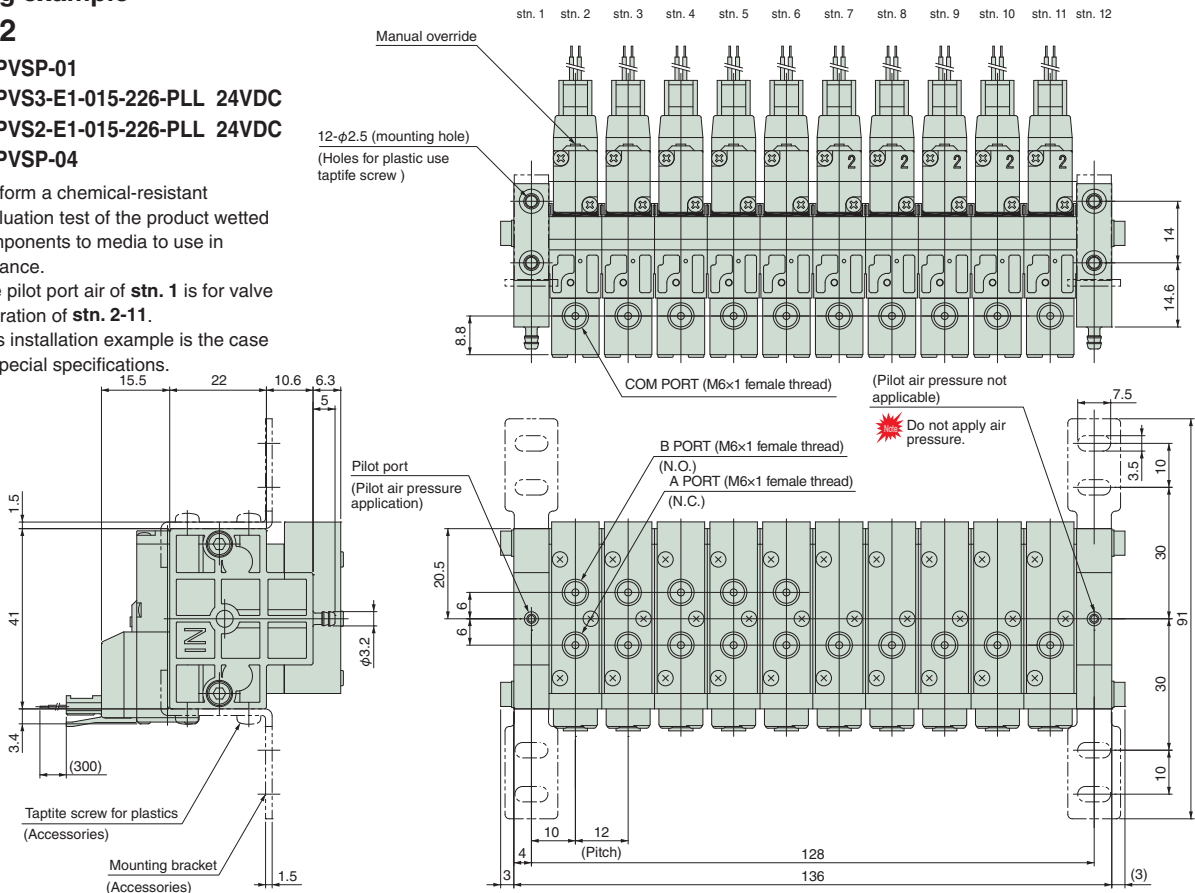

Mounting example

PVSM14

- stn. 1 PVSP-01
- stn. 2-6 PVS3-E1-015-226-PLL 24VDC
- stn. 7 PVS2-015-226
- stn. 8 PVSP-03
- stn. 9-12 PVS2-E1-015-226-PLL 24VDC
- stn. 13 PVS2-015-226
- stn. 14 PVSP-04

- Notes 1: Perform a chemical-resistant evaluation test of the product wetted components to media to use in advance.
- 2: The pilot port air of **stn. 1** is for valve operation of **stn. 2-7** and the pilot port air of **stn. 8** is for valve operation of **stn. 9-13**.
- 3: This installation example is the case of special specifications.

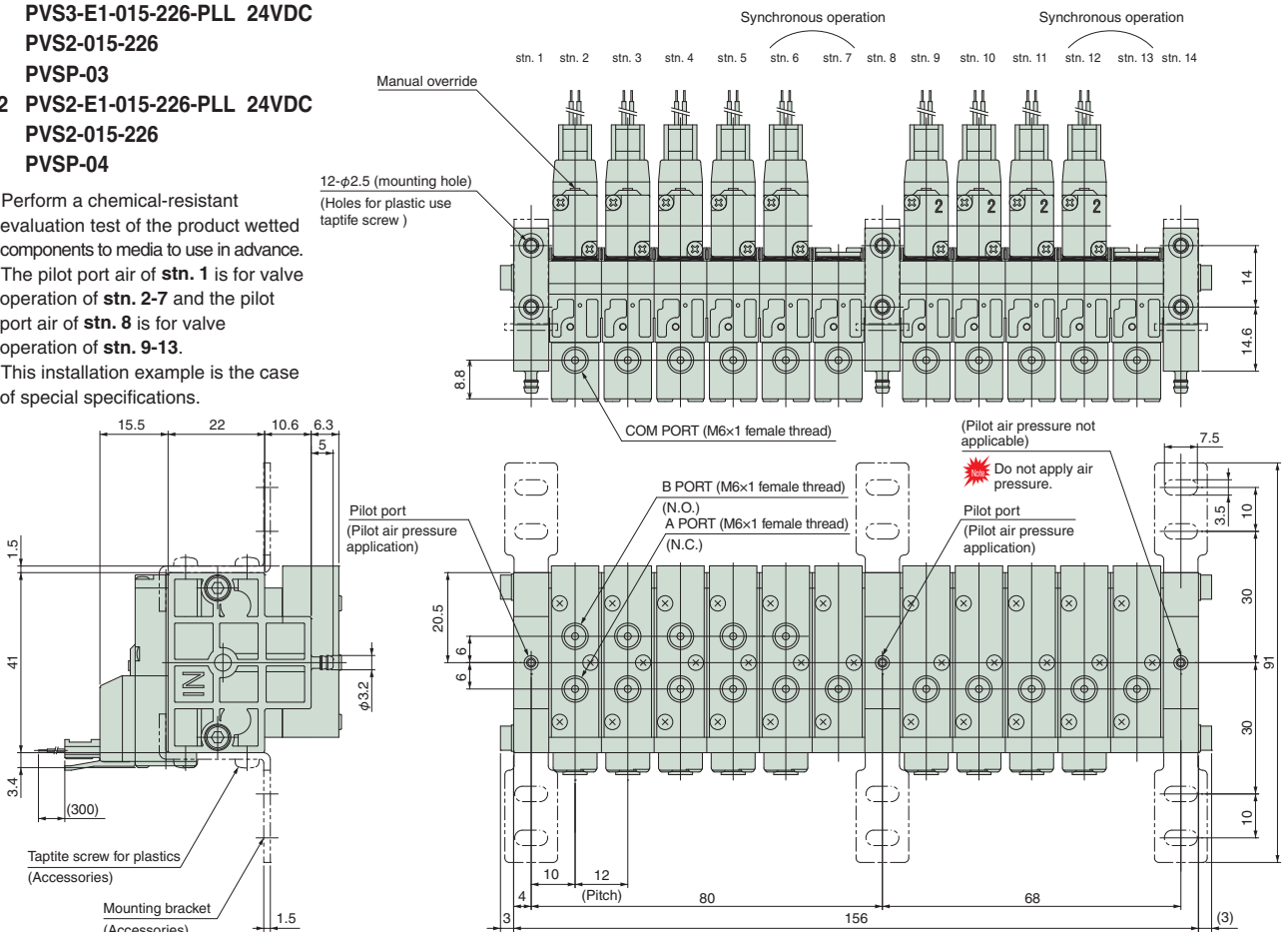

Issue date:

# For PVS series Specification Confirmation Form

Company name	
Contact person	
Order number	

Use this specification confirmation form to order complicated models of PVS series units or confirm specifications. Refer to the following description example to fill in the form with necessary information and send the form to us. (Copy and use this specification confirmation form.)

Unit model: **PVSM**

Model	Wiring connection	Voltage	Station																						
			1	2	3	4	5	6	7	8	9	10	11	12	13	14	15	16	17	18	19	20	21	22	23
PVSP-01			<input type="radio"/>																						
PVS2-015-111																									
PVS2-E1-015-111	PLL/PSL	5VDC/6VDC/12VDC/24VDC																							
PVS3-015-111																									
PVS3-E1-015-111	PLL/PSL	5VDC/6VDC/12VDC/24VDC																							
PVSP-03																									
PVSP-04																									

- : Mounting
- : Synchronous operation

- Note:
- (1) **PVSM13** is not available as a unit model.  
**PVSP-03** should be mounted at the midpoint of stations for **PVSM12** or more units. For more details, refer to Page **7**.
  - (2) Station 1 is fixed to **PVSP-01**.  
**Put only  for PVSP-01, PVSP-03, and PVSP-04.**
  - (3) Up to three valves can operate synchronously. Put up to three consecutive .

## Description example

The case where the number of units is 14 and the model are the following:

- PVSM14**
- stn. 1 PVSP-01
  - stn. 2-6 PVS3-E1-015-111-PLL 24VDC
  - stn. 7 PVS2-015-111
  - stn. 8 PVSP-03
  - stn. 9-12 PVS2-E1-015-111-PLL 24VDC
  - stn. 13 PVS2-015-111
  - stn. 14 PVSP-04

Unit model: **PVSM**

Model	Wiring connection	Voltage	Station																						
			1	2	3	4	5	6	7	8	9	10	11	12	13	14	15	16	17	18	19	20	21	22	23
PVSP-01			<input type="radio"/>																						
PVS2-015-111																									
PVS2-E1-015-111	PLL/PSL	5VDC/6VDC/12VDC/24VDC																							
PVS3-015-111																									
PVS3-E1-015-111	PLL/PSL	5VDC/6VDC/12VDC/24VDC		<input type="radio"/>	<input type="radio"/>	<input type="radio"/>	<input type="radio"/>	<input checked="" type="radio"/>																	
PVSP-03												<input type="radio"/>													
PVSP-04																									

URL <http://www.koganei.co.jp>

E-mail: [overseas@koganei.co.jp](mailto:overseas@koganei.co.jp)



## **KOGANEI CORPORATION**

### **OVERSEAS DEPARTMENT**

3-11-28, Midori-cho, Koganei City, Tokyo 184-8533, Japan  
Tel: 81-42-383-7271 Fax: 81-42-383-7276

### **KOGANEI INTERNATIONAL AMERICA, INC.**

39300 Civic Center Dr., Suite 280, Fremont, CA 94538, U.S.A.  
Tel: 1-510-744-1626 Fax: 1-510-744-1676

### **SHANGHAI KOGANEI INTERNATIONAL TRADING CORPORATION**

Room 2606-2607, Tongda Venture Building No.1, Lane 600, Tianshan Road,  
Shanghai, 200051, China  
Tel: 86-21-6145-7313 Fax: 86-21-6145-7323

### **KOGANEI KOREA CO., LTD.**

KT&G Cosmo Bldg., 3F, 40-13, Maesanno 2-ga, Paldal-gu, Suwon-si, Gyeonggi-do,  
442-847, Korea  
Tel: 82-31-246-0414 Fax: 82-31-246-0415

### **KOGANEI-PORNCHAI CO., LTD.**

89/174 Moo 3, Vibhavadee Rangsit Road, Talad Bangkhen, Laksi, Bangkok,  
10210, Thailand  
Tel: 66-2551-4025 Fax: 66-2551-4015

### **KOGANEI ASIA PTE. LTD.**

12 Arumugam road #03-12, Lion Building B, 409958, Singapore  
Tel: 65-6293-4512 Fax: 65-6293-4513