

KOGANEI

ACCESSORIES GENERAL CATALOG

AIR TREATMENT, AUXILIARY, VACUUM,
AND FLUORORESIN PRODUCTS

DESKTOP TYPE COMPRESSORS CONTENTS

DESKTOP TYPE COMPRESSORS



Features	187
Handling Instructions and Precautions	189
Compressors	
Pneumatic Circuit Diagram/	
Specifications/ Optional Specifications	191
Order Codes/Performance Graph	192
Dimensions	193
Air Tanks	
Pneumatic Circuit Diagram/	
Specifications/ Order Codes	194
Dimensions	195

Desktop Type Compressors

- Footprint: A4 size (210 × 297 mm [8.27 × 11.69 in.])
compact-design horizontal type
(Vertical type saves even more space: 85 × 297 mm [3.35 × 11.69 in.]
- Quiet design: 55 dB or less
- Lightweight: 4.6 kg [10.1 lb.]

Horizontal type

A4 Size

DPP-AY □□

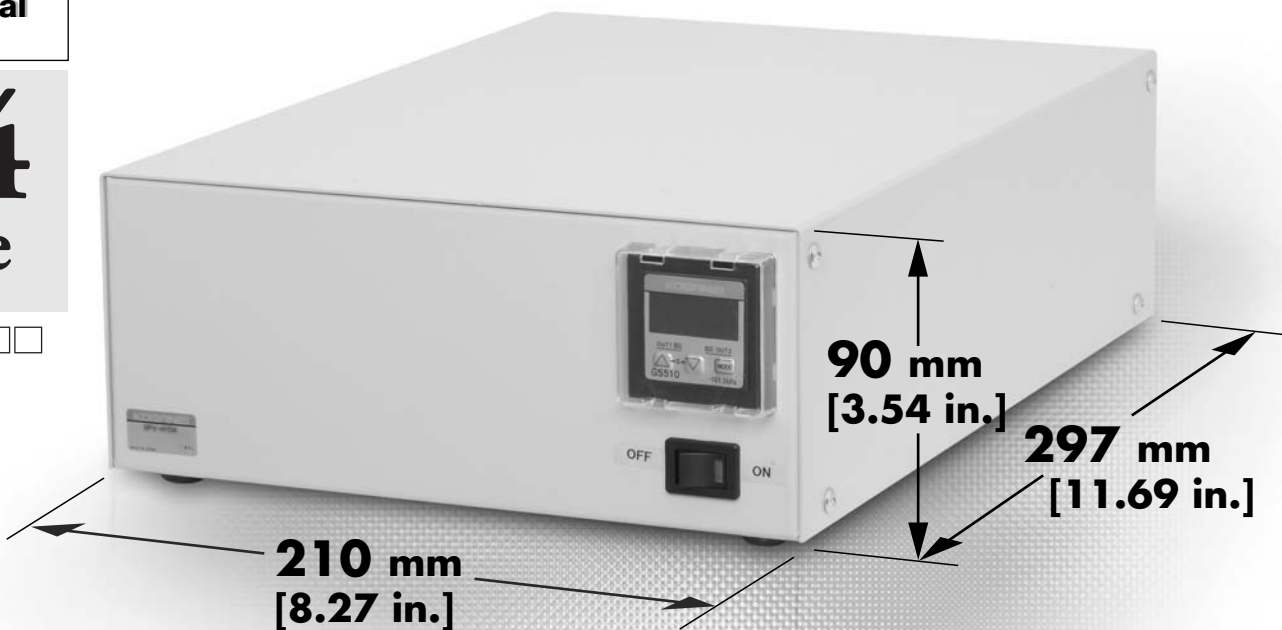

Desktop Type Air Tanks (Capacity 1800 mℓ [109.8 in.³])



Vertical type
DPT-T18

- These air tanks can be installed on either the compressor side or vacuum side.
- Optimum as an auxiliary tank for the desktop type compressor.
- With the same dimensions as the compressor, it does not occupy much space.



Horizontal type
DPT-Y18

- Adding an auxiliary tank to the compressor effectively reduces pressure fluctuations that arise during momentary high-volume consumption of compressed air or vacuum.

Vertical
type
DPP-AT □□

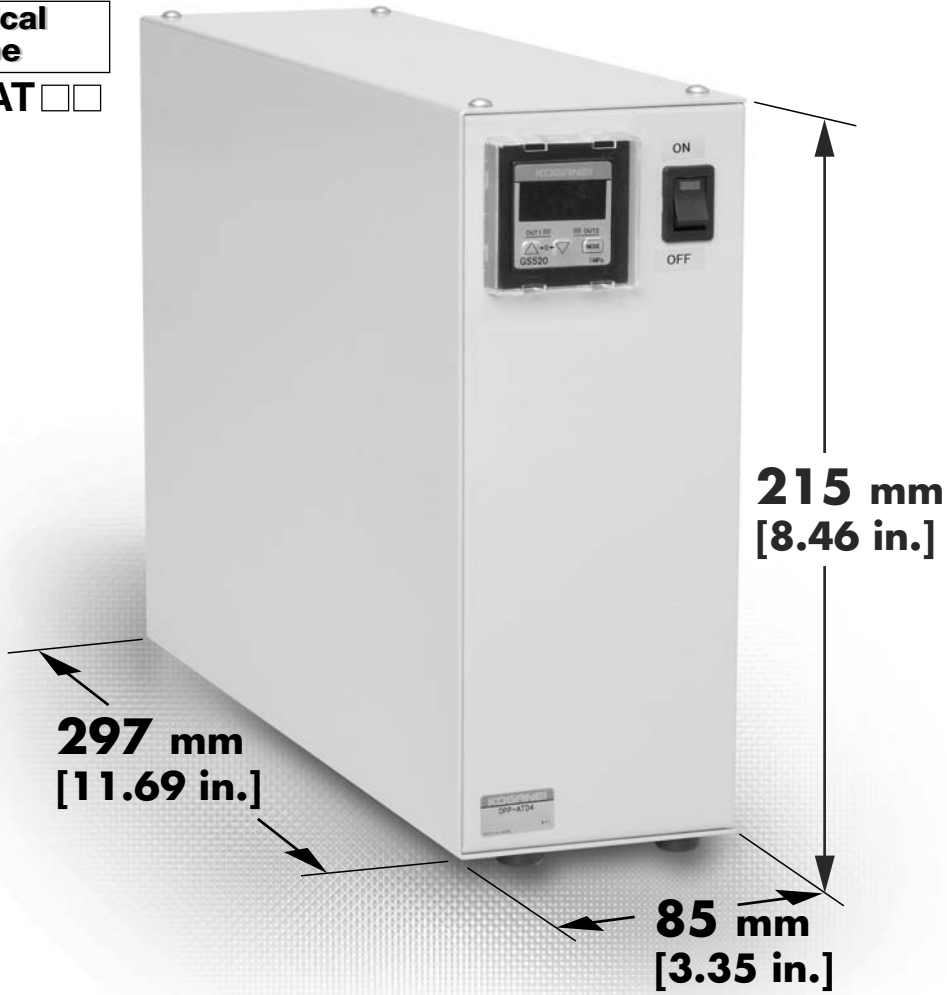

Example of the air tank in combination
with the compressor



Handling Instructions and Precautions

Installation

1. Install the product in a horizontal, flat, firmly supported location, and ensure that it does not rattle during operation.
2. Allow plenty of room for the installation.
3. Avoid use in locations where the body may be subject to dripping water or oil, or to dust.
4. Position so that the side of the compressor with ventilator holes is at least 40 mm [1.57 in.] from any wall, and take care to avoid letting the ventilator holes become blocked. Failure to ensure adequate ventilation space will lead to a reduction in air circulation, causing internal temperatures to rise and a drastic deterioration in operating life.



5. Avoid use in locations where sulfuric acid, hydrochloric acid, or other corrosive gases or ozone are present.
6. Avoid use in locations subject to strong vibrations or shocks.
7. The compressor does not incorporate any internal filter or other filtration device. Mount an air filter and regulator for use.

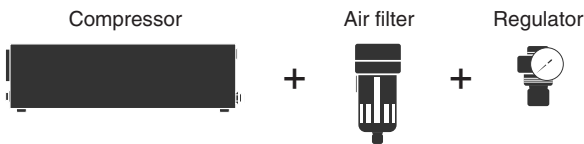

8. Always be sure to equip a residual pressure exhaust mechanism on the compressor's OUT side.

Example

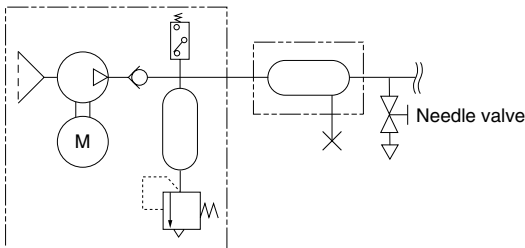

Wiring

1. For a power supply when not using the optional AC adaptor, connect DC24V 2 A (instantaneous current 5 A or more) to a power input jack (ϕ 2.5 mm [0.098 in.] DC jack center plus, any product compatible with the old EIAJ standard RC-6705).
2. When using the AC adaptor, connect the input plug to the power input jack, and then connect the plug to the AC100V power supply.
3. When connecting the power cord, always plug the jack and plug all the way in.
Loose connections can be the cause of electric shock or leak.
4. If the current flowing through the AC adaptor (AD-DPA) exceeds 3.3 A, an overcurrent protection circuit will cut off the circuit. If the unit fails to activate even when the power switch has been turned on, check the AC adaptor's primary outlet. If it still fails to activate when the switch is turned on, inspection and repair is required. Consult us.
5. If not using the optional AC adaptor, place a 3 A overcurrent protection circuit in the power circuit.

Piping

1. The piping port of the compressor and air tank is a quick fitting for a tube with an outer diameter of 6 mm [0.236 in.].
2. Either a nylon tube or urethane tube can be used. For the tube outer diameter precision, use a nylon tube with nominal dimension of ± 0.1 mm [± 0.004 in.], and a urethane tube with nominal dimension of ± 0.15 mm [± 0.0059 in.], while the degree of ellipticity (difference between long diameter and short diameter) should be 0.2 mm [0.008 in.] or less.

- Cautions:**
1. Use tubes without scratches on the outer surface. If scratches appear due to repeated use, cut off that portion.
 2. Do not excessively bend or twist the tube near the fitting. It could be the cause of air leaks.

3. Connecting and disconnecting tube

Caution: Before connecting or disconnecting tubes, always turn off the power switch, and use the residual pressure exhaust mechanism to vent the air.

Precautions for connecting the tube

- (1) Check that the tube cut surface is perpendicular to the tube length, that there is no scratch on the outside of the tube, and that the tube shape has not become elliptical.
- (2) When connecting tubes, failure to push the tube in all the way to the fitting end could result in leaks.

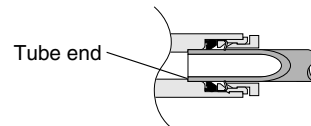

- (3) After connection, check that the tube cannot be pulled out.

Precautions for disconnecting the tube

- (1) When releasing a tube, always check that pressure inside the compressor is at zero.
- (2) Push the release ring evenly all the way to the end, and then pull the tube straight out. An insufficient push could prevent the tube from being pulled out, or leave scratched or scarred tube fragments remaining behind inside the fitting.

Tube connection and disconnection method

1) Connecting the tube

The operator merely needs to push the tube all the way to the end of the quick fitting, after which a lock claw secures it in place, and an elastic sleeve seals the circumference around the tube.

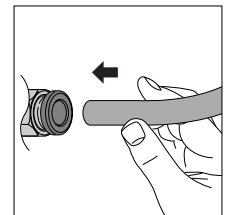

2) Disconnecting the tube

When removing the tube, push the release ring to open the lock claw, and then pull out the tube. Always shut off the air before removal.

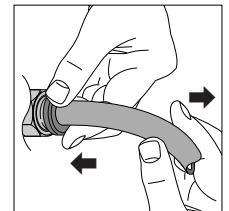

Operation

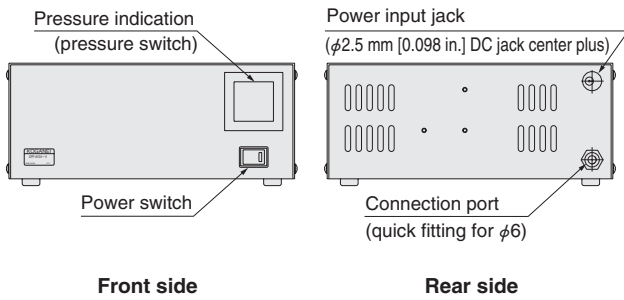

1. Before operation, check that piping and wiring have been properly connected.
2. When the power switch is turned on, the switch lamp lights up and the pressure display value rises. When the pressure inside the compressor reaches 0.55 MPa [80 psi.], it automatically shuts off (unloads). When compressed air is consumed and pressure inside the compressor drops to 0.50 MPa [73 psi.], it automatically restarts (loads).

Caution: If the compressed air consumption exceeds the compressor capacity, the compressor will operate continuously.

3. Turning off the power switch shuts down the equipment operation.

Caution: Take notice that even after compressor operation shuts down, residual pressure remains inside the tank and piping, etc.

4. If a large amount of compressed air is needed for short intervals, installing an air tank **DPT** can be effective.
5. Do not change the pressure switch settings. It could shorten the equipment operating life.
6. The compressor drains collected liquid (moisture). This is not a problem. Make sure to attach an air filter on the secondary side and periodically drain the collected liquid.

Collected liquid draining

On the air tank, remove the drain port plug to drain out the collected liquid. Before removing the drain plug, always release the pressure inside the tank, and check that the pressure is at normal atmospheric pressure. After the collected liquid has been drained, always restore the drain plug to its original position.

-V: drain port with hand valve

For the air tank with a hand valve, the collected liquid can be drained out merely by rotating the flow selector. When the tank is in use, always use in the closed state, as shown in the figure below. To drain out the collected liquid, first release the pressure inside the tank, check that the pressure is at normal atmospheric pressure, and then open the hand valve. To open the valve, rotate the top knob clockwise 90°. When the collected liquid is drained, return the knob to the original closed position.

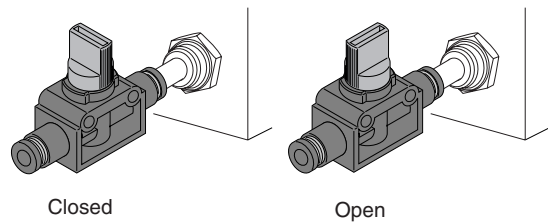

DESKTOP TYPE

Compressors



Pneumatic Circuit Diagram

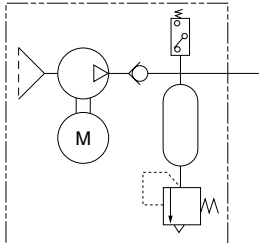

Specifications

Compressor

Item	Model	DPP-AY□□	DPP-AT□□
		Horizontal	Vertical
Input voltage		DC24V (Switching power supply use possible)	
Rated current		2 A (Instantaneous current 5 A or more)	
Input plug		Compatible with ϕ 2.5 mm [0.098 in.] DC jack (Center plus)	
Discharge flow rate		2.0 ℓ /min [0.0706 ft ³ /min.] (at 0.5 MPa [73 psi.])	
Ambient temperature range		0 to 40°C [32 to 104°F] (No freezing or condensation)	
Maximum pressure		0.55 MPa [80 psi.]	
Control pressure	OFF/ON	0.55/0.50 MPa [80/73 psi.] (Unload/Load)	
Built-in tank capacity		900 m ℓ [54.91 in. ³]	
Noise		55 dB	
Connection port		Quick fitting for tube with outer diameter ϕ 6 mm [0.236 in.] ^{Note}	
Mass		4.6 kg [10.1 lb]	

Note: For the tubes used, see p.189 on piping and wiring.

Optional Specifications

AC Adaptor

Items	Model	AD (AD-DPA)
Input voltage		AC100~240V
Output voltage		DC24V
Rated current		2.5 A
Mass		0.32 kg [0.71 lb.]

Order Codes

DPP - [] - [] - []

Desktop type compressor

Device input power supply
D4 : No AC adaptor
AD : With AC adaptor

Assembled option
Blank : None
P : With block-off plug for outlet port



Installation direction
AY : Horizontal



AT : Vertical



Additional Part
AC adaptor
 Model : **AD-DPA**



For the order codes for air tanks with the right fit for the desktop type compressor, see p.194.

Performance Graph

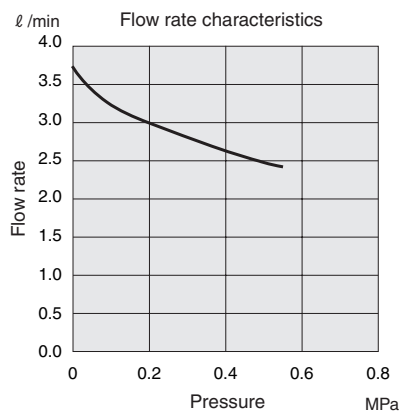

1 l /min = 0.0353 ft.³/min.
 1 MPa = 145 psi.

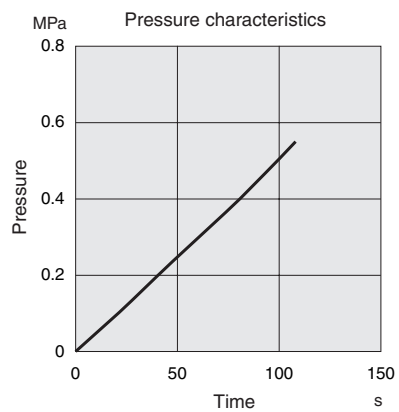

1 MPa = 145 psi.

DPP-AYD4(-P)
DPP-AYAD(-P)
 (Horizontal)

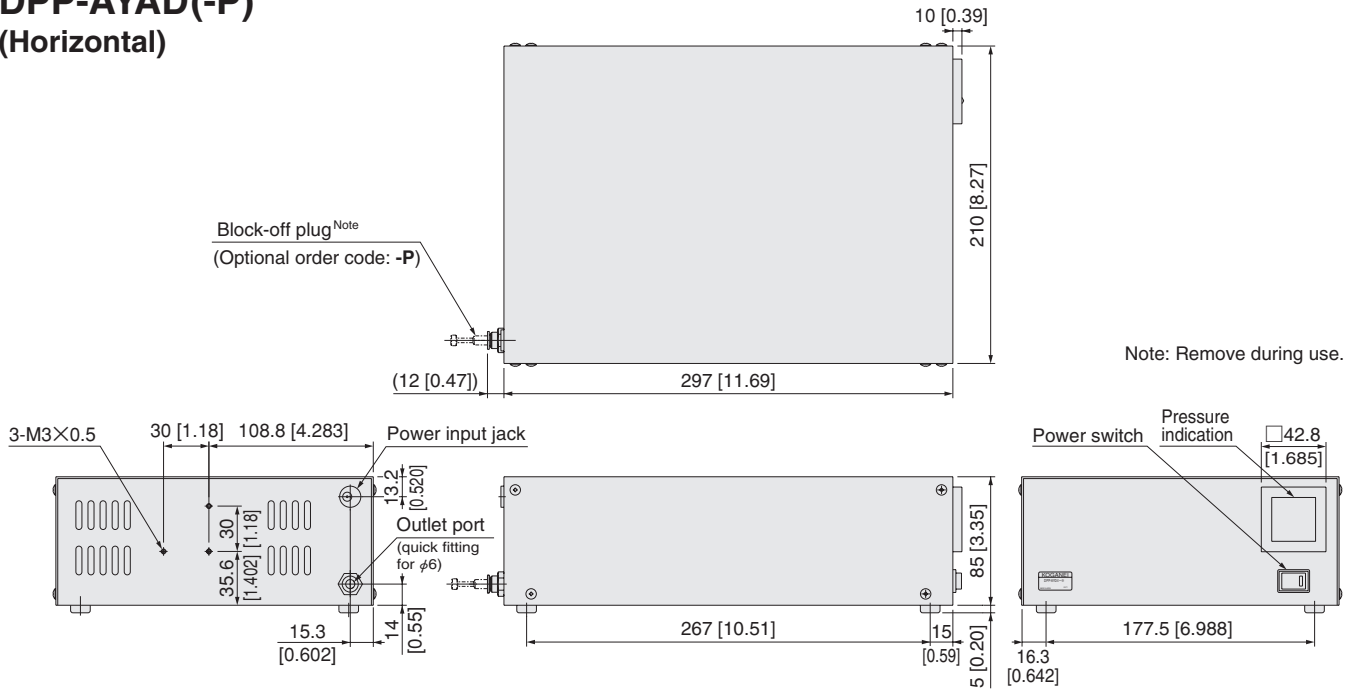

DPP-ATD4(-P)
DPP-ATAD(-P)
 (Vertical)

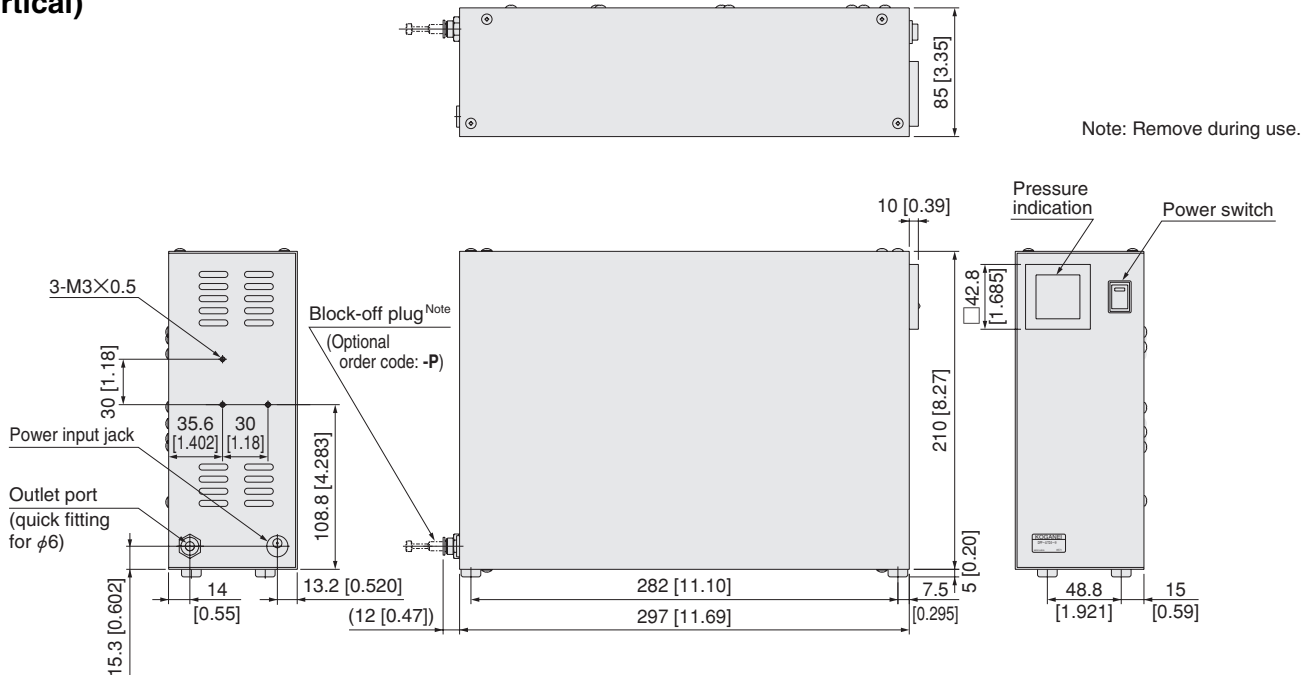

Option
AD (AC adaptor AD-DPA)

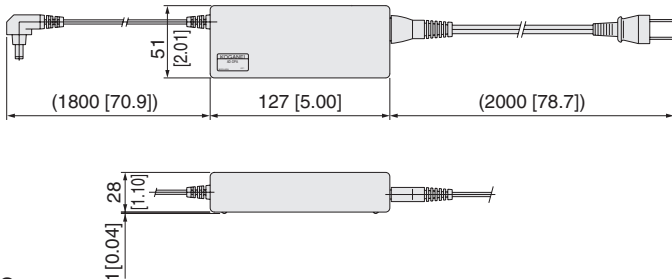

KOGANEI

ACCESSORIES GENERAL CATALOG

AIR TREATMENT, AUXILIARY, VACUUM,
AND FLUORORESIN PRODUCTS

DESKTOP TYPE VACUUM PUMPS CONTENTS



Features	749
Handling Instructions and Precautions	751
Vacuum Pumps	
Pneumatic Circuit Diagram/	
Specifications/ Optional Specifications	753
Order Codes/Performance Graph	754
Dimensions	755
Air Tanks	
Pneumatic Circuit Diagram/	
Specifications/ Order Codes	756
Dimensions	757

Desktop Type Vacuum Pumps

- Footprint: A4 size (210 × 297 mm [8.27 × 11.69 in.])
compact-design horizontal type
(Vertical type saves even more space: 85 × 297 mm [3.35 × 11.69 in.]
- Quiet design: 55 dB or less
- Lightweight: 4.6 kg [10.1 lb.]

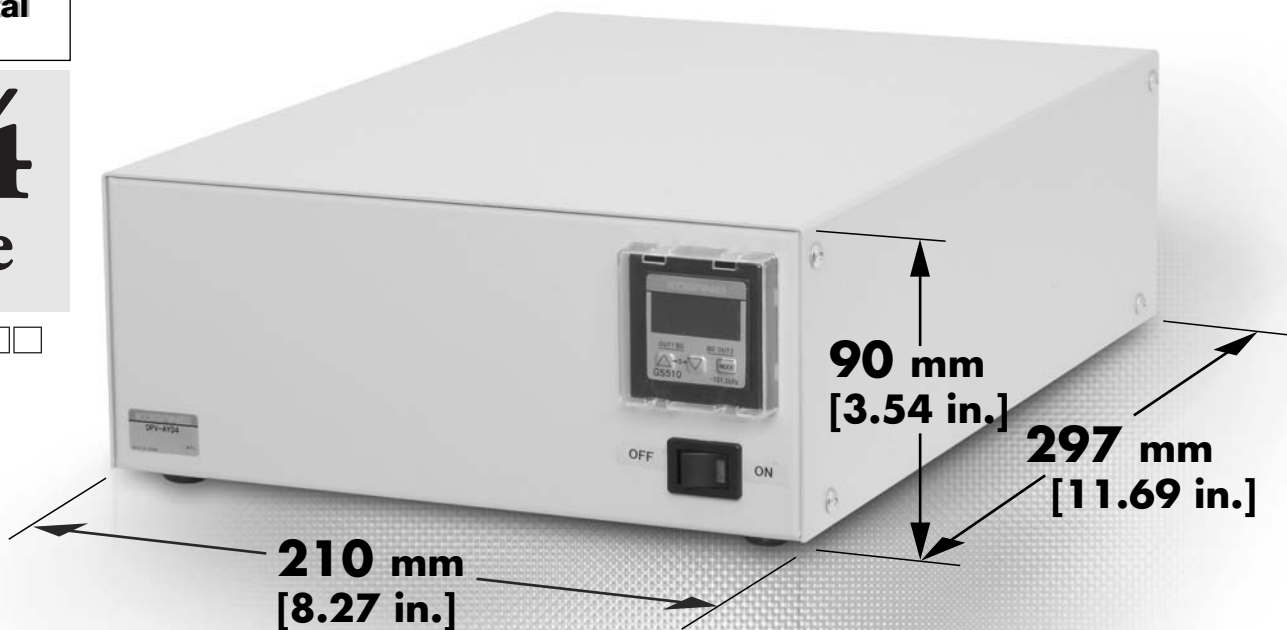

Desktop Type Air Tanks (Capacity 1800 mℓ [109.8 in.³])



Vertical type
DPT-T18

- These air tanks can be installed on either the compressor side or vacuum side.
- Optimum as an auxiliary tank for the desktop type compressor.
- With the same dimensions as the compressor, it does not occupy much space.



Horizontal type
DPT-Y18

- Adding an auxiliary tank to the compressor effectively reduces pressure fluctuations that arise during momentary high-volume consumption of compressed air or vacuum.

**Vertical
type**
DPV-AT □ □

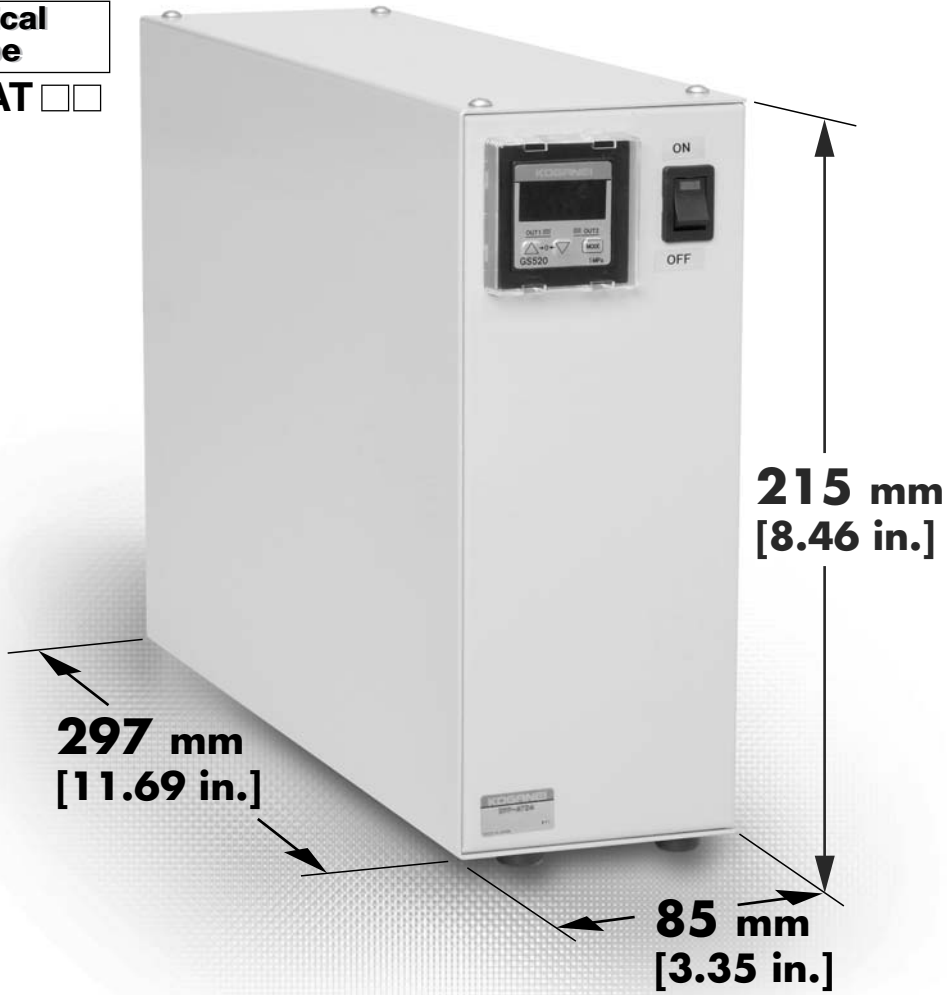

**Example of the air tank in combination
with the compressor**



Handling Instructions and Precautions

Installation

1. Install the product in a horizontal, flat, firmly supported location, and ensure that it does not rattle during operation.
2. Allow plenty of room for the installation.
3. Avoid use in locations where the body may be subject to dripping water or oil, or to dust.
4. Position so that the side of the vacuum pump with ventilator holes is at least 40 mm [1.57 in.] from any wall, and take care to avoid letting the ventilator holes become blocked. Failure to ensure adequate ventilation space will lead to a reduction in air circulation, causing internal temperatures to rise and a drastic deterioration in operating life.

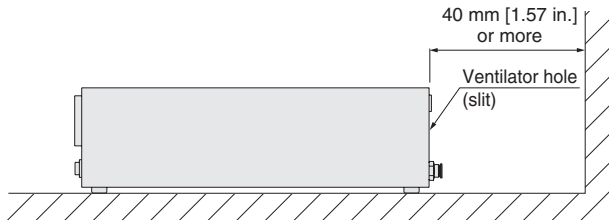

5. Avoid use in locations where sulfuric acid, hydrochloric acid, or other corrosive gases or ozone are present.
6. Avoid use in locations subject to strong vibrations or shocks.
7. Always be sure to install a filter to the vacuum pump inlet port. Failure to use a filter will result in grit and dust particles clogging the pump, leading to function shutdown in a short time, to rapid deterioration of performance, and to shortened operating life.
8. Always be sure to equip a residual pressure exhaust mechanism on the vacuum pump's OUT side.

Example

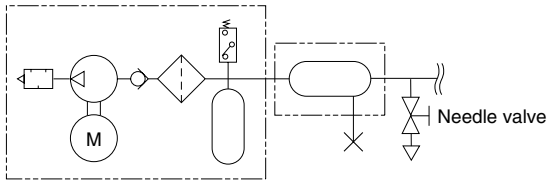

Wiring

1. For a power supply when not using the optional AC adaptor, connect DC24V 2 A (instantaneous current 5 A or more) to a power input jack (ϕ 2.5 mm [0.098 in.] DC jack center plus, any product compatible with the old EIAJ standard RC-6705).
2. When using the AC adaptor, connect the input plug to the power input jack, and then connect the plug to the AC100V power supply.
3. When connecting the power cord, always plug the jack and plug all the way in.
Loose connections can be the cause of electric shock or leak.
4. If the current flowing through the AC adaptor (**AD-DPA**) exceeds 3.3 A, an overcurrent protection circuit will cut off the circuit. If the unit fails to activate even when the power switch has been turned on, check the AC adaptor's primary outlet. If it still fails to activate when the switch is turned on, inspection and repair is required. Consult us.
5. If not using the optional AC adaptor, place a 3 A overcurrent protection circuit in the power circuit.

Piping

1. The piping port of the vacuum pump and air tank is a quick fitting for a tube with an outer diameter of 6 mm [0.236in.].
2. Either a nylon tube or urethane tube can be used. For the tube outer diameter precision, use a nylon tube with nominal dimension of ± 0.1 mm [± 0.004 in.], and a urethane tube with nominal dimension of ± 0.15 mm [± 0.0059 in.], while the degree of ellipticity (difference between long diameter and short diameter) should be 0.2 mm [0.008 in.] or less.

- Cautions:**
1. Use tubes without scratches on the outer surface. If scratches appear due to repeated use, cut off that portion.
 2. Do not excessively bend or twist the tube near the fitting. It could be the cause of air leaks.

3. Connecting and disconnecting tube

- Caution:** Before connecting or disconnecting tubes, always turn off the power switch, and use the residual pressure exhaust mechanism to vent the air.

Precautions for connecting the tube

- (1) Check that the tube cut surface is perpendicular to the tube length, that there is no scratch on the outside of the tube, and that the tube shape has not become elliptical.
- (2) When connecting tubes, failure to push the tube in all the way to the fitting end could result in leaks.

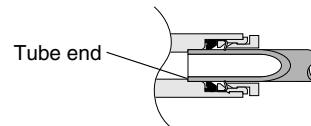

- (3) After connection, check that the tube cannot be pulled out.

Precautions for disconnecting the tube

- (1) When releasing a tube, always check that pressure inside the compressor is at zero.
- (2) Push the release ring evenly all the way to the end, and then pull the tube straight out. An insufficient push could prevent the tube from being pulled out, or leave scratched or scarred tube fragments remaining behind inside the fitting.

Tube connection and disconnection method

1) Connecting the tube

The operator merely needs to push the tube all the way to the end of the quick fitting, after which a lock claw secures it in place, and an elastic sleeve seals the circumference around the tube.

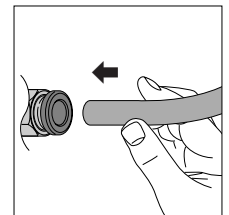

2) Disconnecting the tube

When removing the tube, push the release ring to open the lock claw, and then pull out the tube. Always shut off the air before removal.

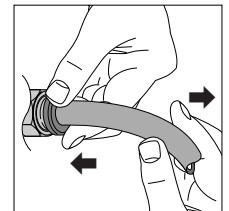

Operation

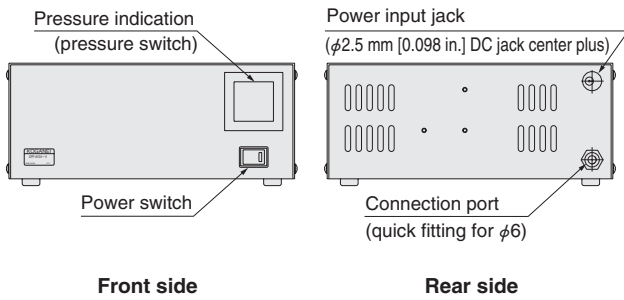

1. Before operation, check that piping and wiring have been properly connected.
2. The power switch lamp lights up when the switch is on and the pressure display value to drop. When pressure inside the vacuum pump reaches -50 kPa [-14.77 in.Hg], it automatically stops (unloads). Sucking in air causes the pressure inside the vacuum pump to rise, and when the pressure reaches -30 kPa [-8.86 in.Hg], the pump automatically restarts (loads).

Caution: If the air suction amount exceeds the vacuum pump capacity, the vacuum pump will operate continuously.

3. Turning off the power switch shuts down the equipment operation.

Caution: Take notice that even after vacuum pump operation shuts down, residual pressure remains inside the tank and piping, etc.

4. If a large amount of vacuum is needed for short intervals, installing an air tank **DPT** can be effective.
5. Do not change the pressure switch settings. It could shorten the equipment operating life.

Collected liquid draining

On the air tank, remove the drain port plug to drain out the collected liquid. Before removing the drain plug, always release the pressure inside the tank, and check that the pressure is at normal atmospheric pressure. After the collected liquid has been drained, always restore the drain plug to its original position.

-V: drain port with hand valve

For the air tank with a hand valve, the collected liquid can be drained out merely by rotating the flow selector. When the tank is in use, always use in the closed state, as shown in the figure below. To drain out the collected liquid, first release the pressure inside the tank, check that the pressure is at normal atmospheric pressure, and then open the hand valve. To open the valve, rotate the top knob clockwise 90° . When the collected liquid is drained, return the knob to the original closed position.

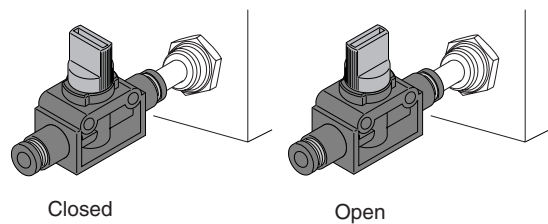

DESKTOP TYPE

Vacuum Pumps



Pneumatic Circuit Diagram

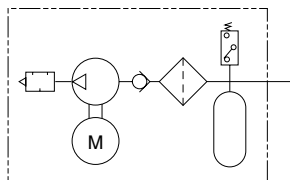

Specifications

Vacuum Pump

Item	Model	DPV-AY□□	DPV-AT□□
		Horizontal	Vertical
Input voltage		DC24V (Switching power supply use possible)	
Rated current		2 A (Instantaneous current 5 A or more)	
Input plug		Compatible with ϕ 2.5 mm [0.098 in.] DC jack (Center plus)	
Suction flow rate		5.7 ℓ /min [0.201 ft. ³ /min.]	
Ambient temperature range		0 to 40°C [32 to 104°F] (No freezing or condensation)	
Maximum vacuum		-75 kPa [-22.16 in.Hg]	
Control vacuum	OFF/ON	-50/-30 kPa [-14.77/-8.86 in.Hg] (Unload/Load)	
Built-in tank capacity		900 m ℓ [54.91 in. ³]	
Noise		55 dB	
Connection port		Quick fitting for tube with outer diameter ϕ 6 mm [0.236 in.] ^{Note}	
Mass		4.6 kg [10.1 lb.]	

Note: For the tubes used, see p.751 on piping and wiring.

Optional Specifications

AC Adaptor

Items	Model	AD (AD-DPA)
Input voltage		AC100~240V
Output voltage		DC24V
Rated current		2.5 A
Mass		0.32 kg [0.71 lb.]

Order Codes

DPV - [] - [] - []

Desktop type vacuum pump

Device input power supply
D4 : No AC adaptor
AD : With AC adaptor

Assembled option
Blank : None
P : With block-off plug for inlet port



Installation direction
AY : Horizontal



AT : Vertical



Additional Part
AC adaptor
 Model : **AD-DPA**



For the order codes for air tanks with the right fit for the desktop type vacuum pump, see p.756.

Performance Graph

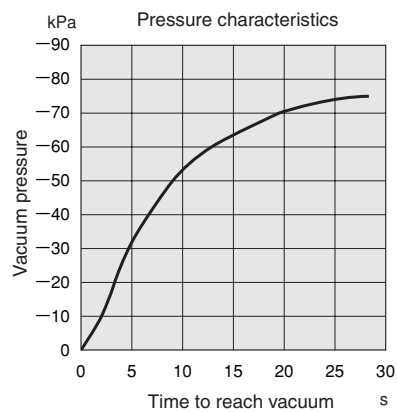
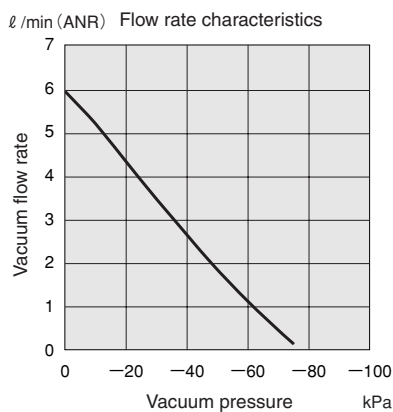

1 ℓ/min = 0.0353 ft.³/min.

-100 kPa = -29.54 in.Hg

DPV-AYD4(-P)
DPV-AYAD(-P)
 (Horizontal)

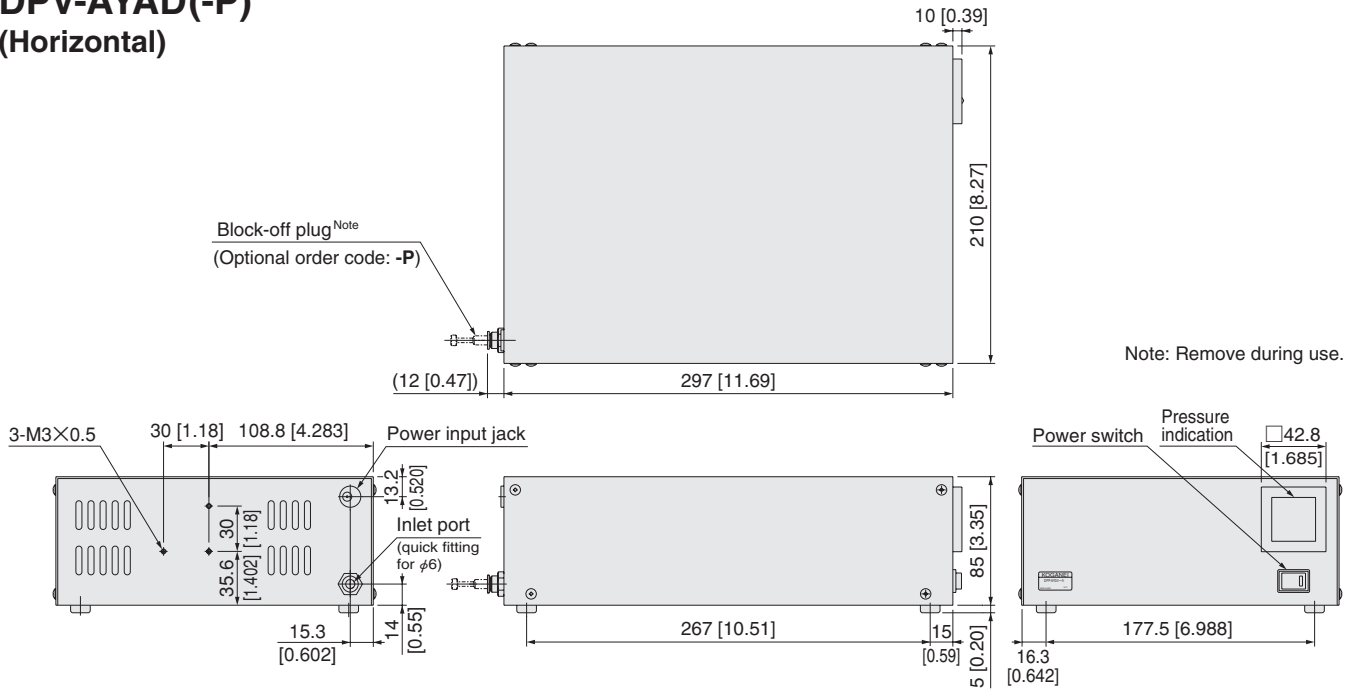

DPV-ATD4(-P)
DPV-ATAD(-P)
 (Vertical)

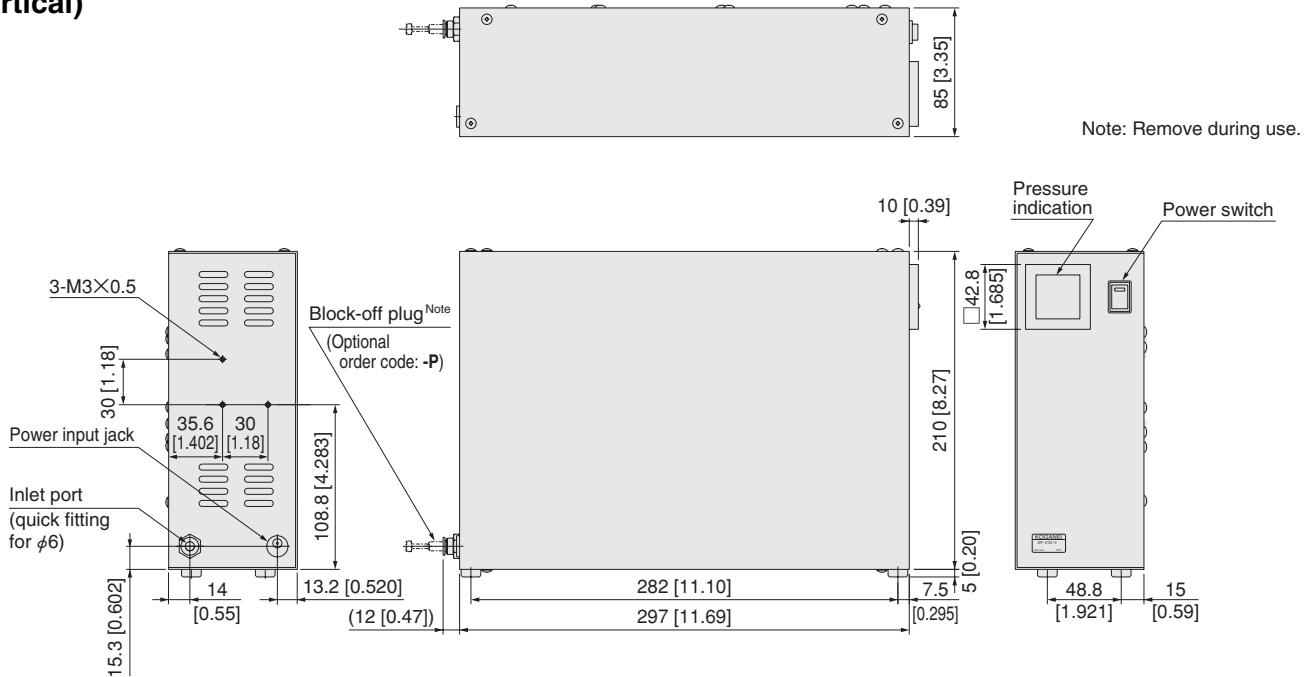

Option
AD (AC adaptor AD-DPA)

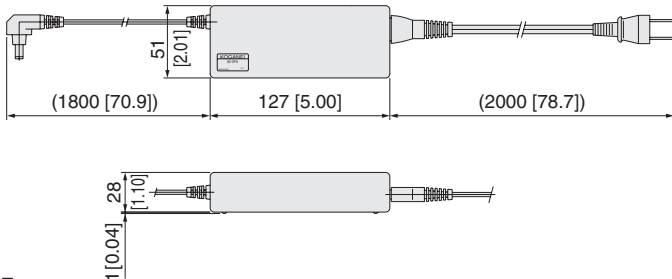

DESKTOP TYPE

Air Tanks

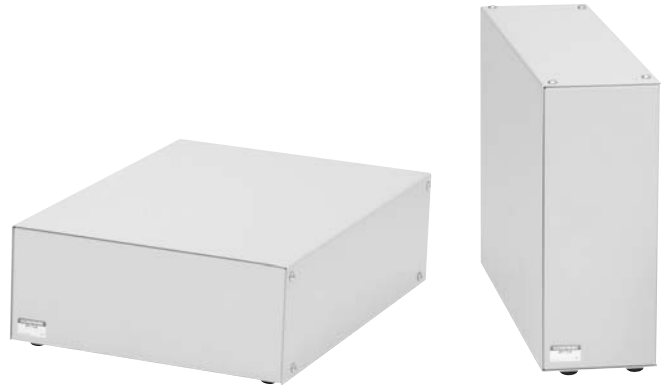

Pneumatic Circuit Diagram

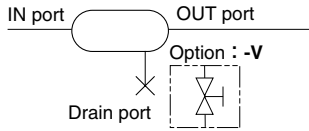

Specifications

Air tank

Item	Model	DPT-Y18	DPT-T18
Installation direction		Horizontal	Vertical
Media		Air	
Maximum operating pressure		0.8 MPa [116 psi.]	
Ambient temperature range		0 to 40°C [32 to 104°F] (No freezing)	
Built-in tank capacity		1800 mℓ [109.82 in. ³]	
Connection port		Quick fitting for tube with outer diameter ϕ 6 mm [0.236 in.] ^{Note}	
Mass		3.2 kg [7.1 lb.]	

Note: For the tubes used, see p.751 on piping and wiring.

Order Codes

DPT - [] 18 - [] - []

Desktop type air tank

Tank capacity
18 : 1800 mℓ [109.82 in.³]

Installation direction
Y : Horizontal

Drain port
P : With block-off plug

Assembled option
Blank : None
P : With block-off plug

T : Vertical

V : With hand valve

DPT-Y18-P(-P)
(Horizontal)

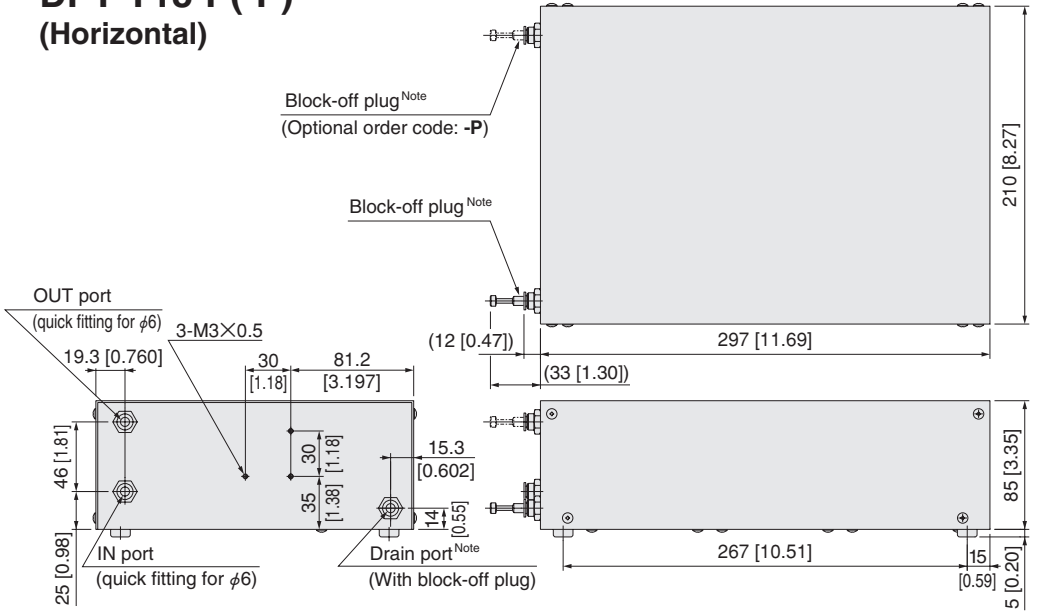

Note: During use, remove the block-off plug on the OUT port. Other than for draining collected liquid, never remove the block-off plug on the drain port.

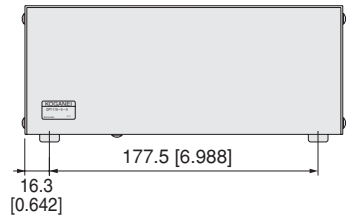

DPT-T18-P(-P)
(Vertical)

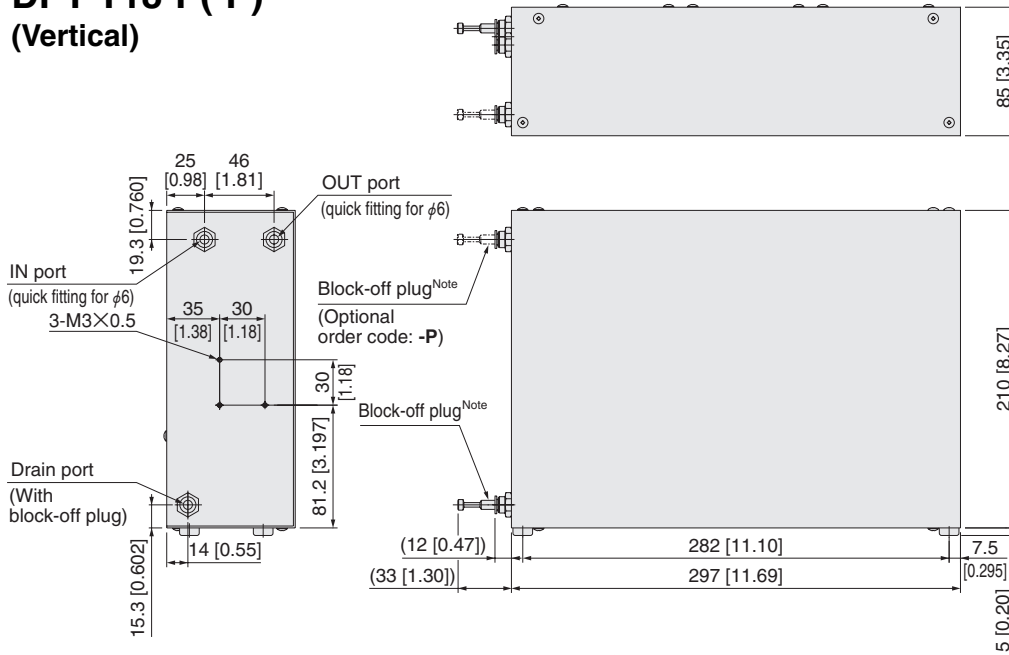

Note: During use, remove the block-off plug on the OUT port. Other than for draining collected liquid, never remove the block-off plug on the drain port.

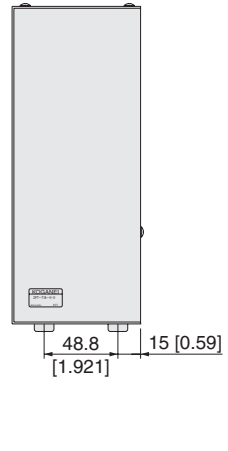

Options

DPT-Y18-V

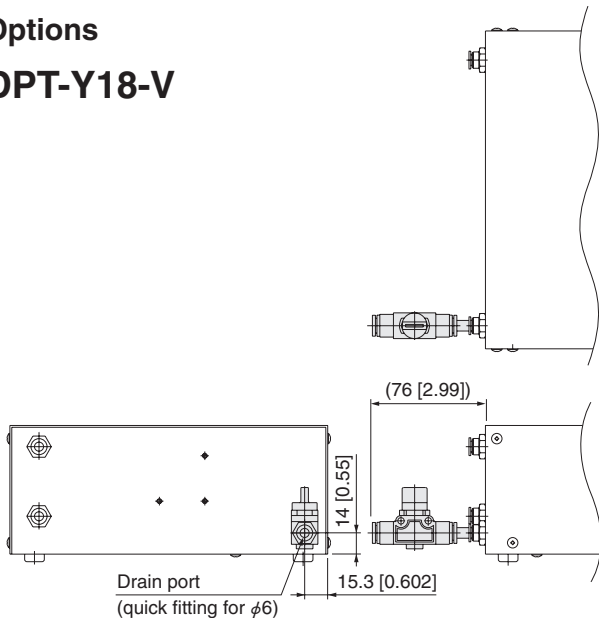

DPT-T18-V

