

# COMPACT FR Series

- Compact and lightweight Air Filters, Regulators, and Filter/Regulators.
- A diaphragm is used in the regulator to provide good regulating performance. Conforms to non-grease specification.<sup>Note</sup>
- It is easy to install and use at airline ends.
- Fittings are supplied with the product as standard, making it easy to connect into applications.
- Standard products can be used as non-ion (NCU) specification products (excluding pressure gauge).

Note: When assembling, a minimal amount of grease must be applied to required parts.  
Accordingly this product does not completely conform to non-grease specification.

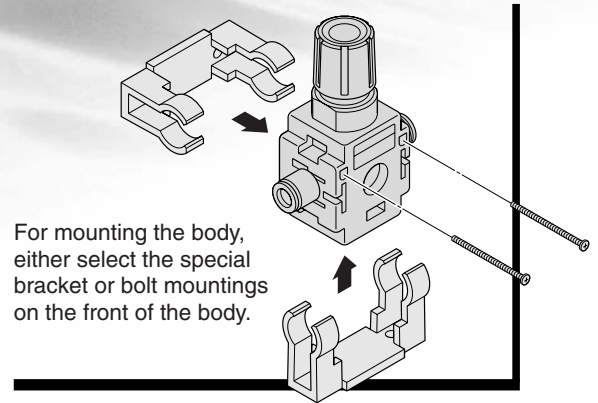

## Air Filters



### ■ FN100

- This can be used for both pressure and vacuum use.

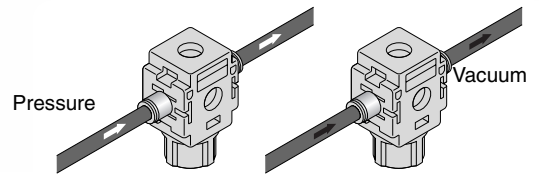

### ■ VFN100

- Air filters for both vacuum and vacuum breaking.
- Suitable to install and use just before vacuum pads, etc.

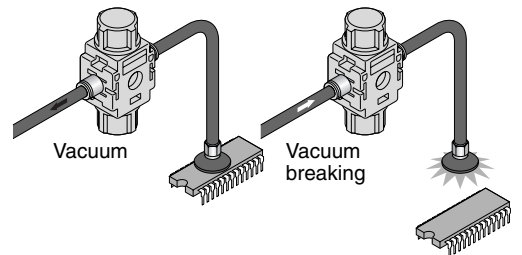

Side piping

Bottom piping



## Regulators

- Available in side piping and bottom piping (for panel mounting).
- Two pressure ranges are offered, 0.7MPa [102psi.] and 0.25MPa [36psi.].
- Relief or non-relief options are available.



## Filter/Regulators

- Integral filter and regulator unit.
- Total height is a compact 72mm [2.835in.].

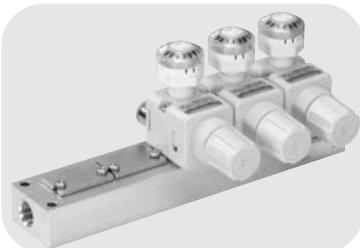

## Manifold Regulators

- Regulators can be installed on manifolds from two to five stations.
- Choose from a selection of four types in pressure range and relief specifications.



## Mounting and piping

1. While any mounting direction is acceptable, be careful to avoid directly applying strong shocks or vibrations to the body.

2. Pressure gauge connection port tightening torque

Since the body is made of plastic, ensure that the tightening torque for the pressure gauge connection port (Rc1/8) remains within the figures shown below, and always use sealing tape.

The recommended tightening torque for Rc1/8 fitting of 686~886N·cm [5.06~6.54ft·lb] will damage the body.

### MAX.150N·cm [13.3in·lb]

When mounting the pressure gauge, always use a wrench on the hexagonal section to tighten, and take care to avoid applying force on the gauge section. Moreover, if not mounting a pressure gauge to the pressure gauge connection port, use a plug wound sealing tape round it to block with the specified tightening torque.

3. When connecting piping to single units of the Compact FR Series, ensure that the piping matches the flow direction mark (▷). The flow marks are located as shown in the figure below.

#### ● For filters

The piping direction differs in accordance with using pressure or vacuum. Follow the figures below when piping.

#### FN100(Pressure)

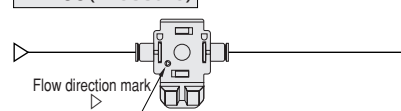

#### FN100(Vacuum)

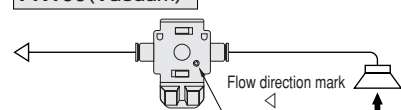

#### VFN100 (Get air supply on the flow direction mark side)

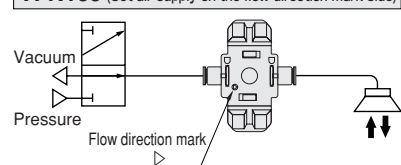

● For side piping regulators and filter regulators, the flow direction mark (▷) is located as shown in the figure below.

#### RN1

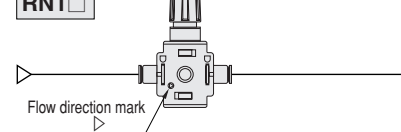

4. When mounting single units of the Compact FR Series, use either the body mounting holes or brackets (optional). Mounting rings (optional) can also be used for panel mounting. The mounting hole for mounting on panels, etc., is  $\phi$  18.5 [0.728in.].



## Pressure regulating

5. For regulators, connect the piping so that the air supply side is connected to the IN port, and the actuator side is connected to the OUT port.

**Cautions:** 1. The product cannot be used with the IN and OUT port piping connections reversed.

2. Avoid mounting that blocks the relief holes. Blocked relief holes will hinder pressure regulating.

6. As filters in the Compact FR Series are provided for the purpose of eliminating solid contents, always eliminate any moisture or oil before operation. To remove collected liquid is not possible.

#### ● Recommended circuit

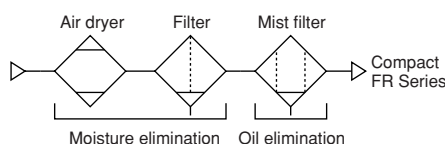

7. The Compact FR Series cannot be disassembled or reassembled. If a filter element reaches the end of its operating life, replace the product with a new unit.

8. Cracks or scratches on the air filter's bowl or body can lead to damage. Replace with a new unit.

9. Connecting and disconnecting tubes  
For tube connection, insert a tube as far as contacting with the tube stopper, and pull it to check the connection.

For tube disconnection, push the tube against the tube stopper, then push the release ring and at the same time pull the tube out.

#### 10. Usable tubes

Use either a nylon tube or urethane tube. Use tubes with an outer diameter tolerance within  $\pm 0.1\text{mm}$  [ $\pm 0.004\text{in.}$ ] of the nominal diameter for nylon tubes, and within  $\pm 0.15\text{mm}$  [ $\pm 0.006\text{in.}$ ] for urethane tubes, and allowance of out-of-ellipticity (difference between long diameter and short diameter) is 0.2mm [0.008in.] or less.

**Cautions:** 1. Only use tubes without scratch on the outer surface. When scratch has been made during repeated use, cut off the scratched section.

2. Do not bend the tube excessively near the fittings. The minimum bending radius for nylon tubes is as shown in the table below.

		mm [in.]
Tube size		Minimum bending radius
$\phi 4$ [0.157], 1/8		20 [0.79]
$\phi 6$ [0.236], 1/4		30 [1.18]

11. Use sufficient size tubes for piping to the IN port of the manifold regulators, and to supply air from the IN ports on both manifold ends is recommended.

1. Do not set the pressure to exceed the setting pressure ranges. It could damage the regulator or cause a sudden rise in secondary pressure (up to the same pressure as the primary pressure).

2. Set the pressure in the increasing pressure direction, while checking with the pressure gauge. Setting the pressure in the decreasing pressure direction can result in inaccurate pressure setting.

3. Maintain the primary pressure so that it has enough margin to the set pressure.

4. If the secondary pressure exceeds the set pressure for some reason, design the safety circuit and equipment to prevent damage to devices and personal injury.

5. Firmly pull out the knob for pressure regulating. Turning it to the right (clockwise direction) increases the pressure, while turning it to the left (counterclockwise direction) decreases the pressure. After regulating pressure, push the knob back into the body and lock it in place.

When regulating the pressure, rotating the knob excessively in pressure increasing or decreasing direction, knob's inner center section might deform and it would cause hard regulating. The knob is fixed to the bonnet by snap hook, accordingly applying excessive axial force to the knob when releasing the lock could cause it to disengage. Re-snap hook for use, in the case.

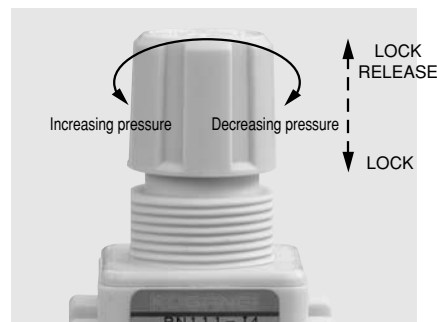

## General precautions

1. Before piping, always thoroughly blow off (use compressed air) the tubing. Entering metal chips, sealing tape, rust, etc., generated during plumbing could result in air leaks or other defective operation.

2. Use air for the media. For the use of any other media, consult us.

3. The product cannot be used when the media or ambient atmosphere contains any of the substances listed below. Organic solvents, phosphate ester type hydraulic oil, sulphur dioxide, chlorine gas, or acids, etc.

4. If using in locations subject to dripping water, dripping oil, etc., or to large amounts of dust, use something to cover and protect the unit.

# FILTER REGULATORS



## Symbols

### ● Relief specification

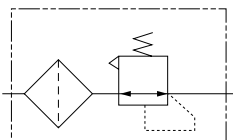

### ● Non-relief specification

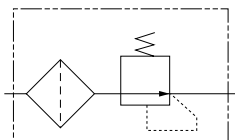

## Order Codes

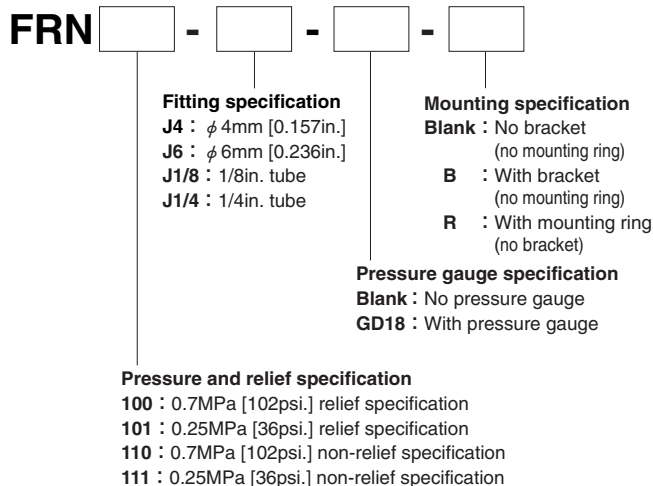

### ● Order code for bracket only

**B-RN100**

### ● Order code for mounting ring only

**R-RN100**

### ● Order code for pressure gauge only

**G1-18D**

## Specifications

Item	Model	Standard	Low pressure
		FRN100	FRN101
		FRN110	FRN111
Media		Air	
Piping connection fitting		$\phi$ 4mm [0.157in.], $\phi$ 6mm [0.236in.], 1/8in. or 1/4in.	
Pressure setting range	MPa [psi.]	0.05~0.7 [7~102]	0.05~0.25 [7~36]
Maximum operating pressure	MPa [psi.]	1 [145]	
Proof pressure	MPa [psi.]	1.5 [218]	
Operating temperature range (atmosphere and media)	$^{\circ}$ C [ $^{\circ}$ F]	5~50 [41~122]	
Lubrication		Prohibited	
Mass	g [oz]	42 [1.48]	
	Option	Pressure gauge: 15 [0.53], Mounting ring: 1.2 [0.042], Bracket: 5.5 [0.194]	
Filtration	$\mu$ m	5	
Materials	Body	Plastic	
	Bonnet	Plastic	
	Bowl	Nylon	
	Diaphragm	Synthetic rubber	
	O-ring	Synthetic rubber	
	Valve	Synthetic rubber and aluminum alloy	
	Element	PVF	
Regulating spring	Piano wire (zinc plated)		

## Inner Construction

FRN1

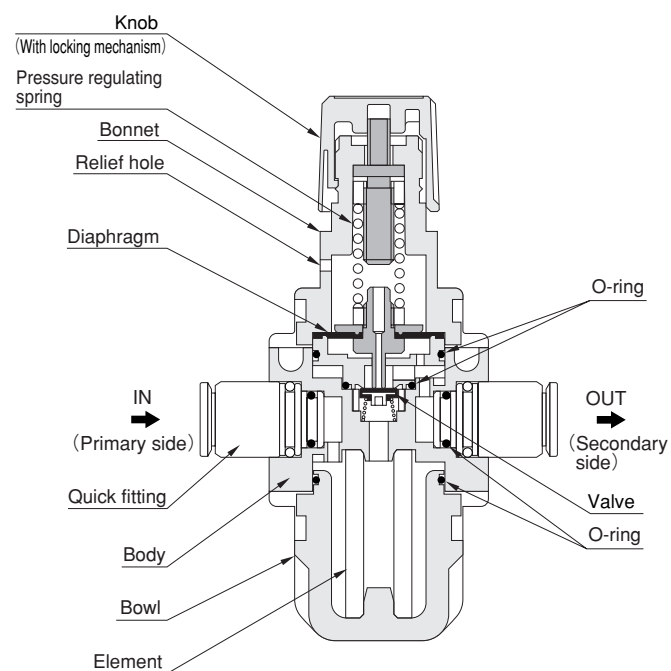

## Flow Rate Characteristics

FRN1□0-J4, J1/8

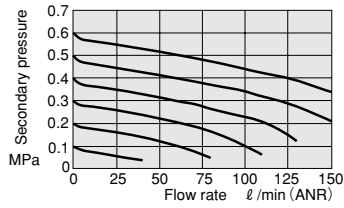

FRN1□0-J6, J1/4

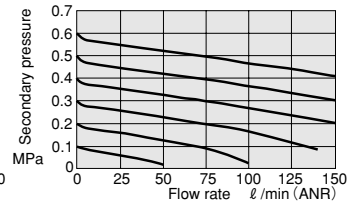

FRN1□1-J4, J1/8

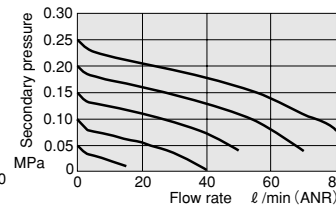

FRN1□1-J6, J1/4

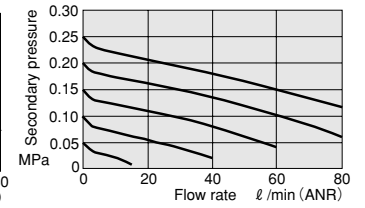

1MPa = 145psi. 1 l/min = 0.0353ft<sup>3</sup>/min.

Remark: Graphs show the flow rate when the primary pressure is constant at 0.7MPa [102psi.].

## Pressure Characteristics

FRN1□0

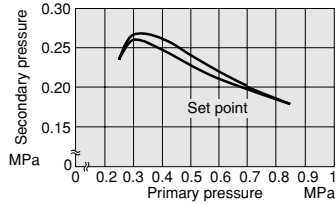

FRN1□1

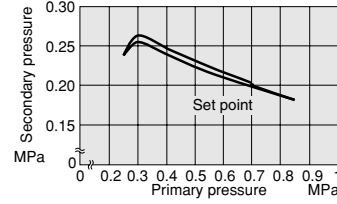

1MPa = 145psi.

## Dimensions of Filter Regulators (mm)

FRN1□□

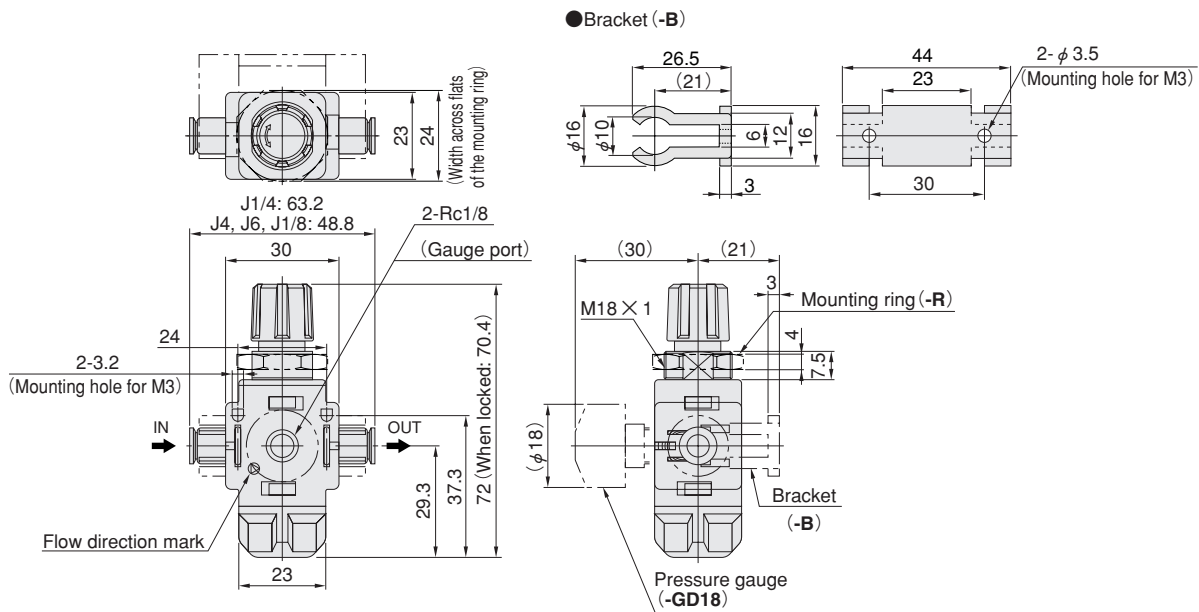

Note: The required mounting hole when the regulator is installed to a panel, etc., is φ 18.5 [0.728in.].

# COMPACT PRESSURE GAUGE

G1-18D



## Symbol

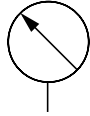

## Order Code

G1-18D

## Specifications

Item	Model	G1-18D
Media		Air
Port size		R1/8
Pressure indication range MPa [psi.]		0~1.0 [0~145]
Accuracy		F.S.±5%
Outer diameter mm [in.]		φ 18 [0.71]
Maximum operating pressure MPa [psi.]		0.93 [135]
Mass g [oz]		15 [0.53]
Material		Zinc die-casting

## Dimensions of Compact Pressure Gauge (mm)

G1-18D

CAD G1-18d

