

VACUUM GAUGES

GV-40, GPV-40



Symbol



Specifications

Item	Model	GV-40-01	GV-40, GPV-40
Media		Air	
Pressure indication range kPa [in.Hg]		0 ~ 100 [0 ~ 29.54]	
Accuracy		F.S. ± 3%	
Operating temperature range °C [°F]		5 ~ 60 [41 ~ 140]	
Port size		R1/8 (female thread M5 × 0.8)	R1/4 (female thread M5 × 0.8)
Mass	kg [lb.]	0.08 [0.18]	0.09 [0.20]

Order Codes

GV - 40 - [] - []

Non-ion specification
Blank — Standard specification
NCU — Non-ion specification

Port size
Blank — R1/4
01 — R1/8

Outer diameter
40 — Outer diameter 40mm [1.57in.]

Vacuum gauge

Dimensions (mm)

GV-40-01

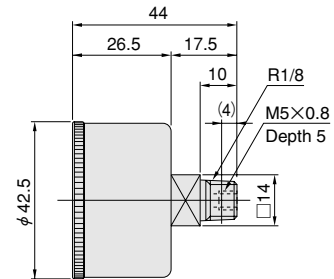
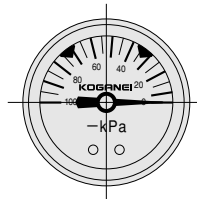

GV-40

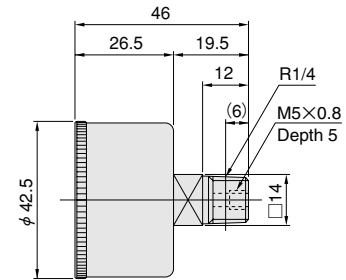
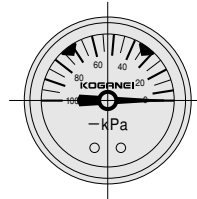

GPV - 40

Outer diameter
40 — Outer diameter 40mm [1.57in.]

Panel mounting vacuum gauge

GPV-40

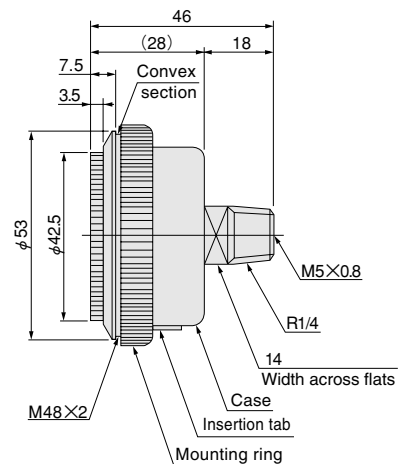
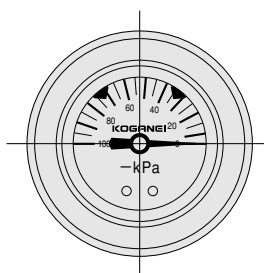

※ For handling instructions and precautions, see p.176.
 ※ For the panel cut dimensions, see p.173.

Handling Instructions and Precautions



**Small Pressure Gauge, Pressure Gauge, Panel Mounting Pressure Gauge
Small Precision Pressure Gauge, Vacuum Gauge**

Mounting and piping

● Small Pressure Gauge, Pressure Gauge, Small Precision Pressure Gauge, Vacuum Gauge

1. While any mounting direction is acceptable, install a throttle mechanism, etc., when mounting between a valve and actuator, or other location where pressure fluctuation can be intense.
2. When mounting and piping a pressure gauge, never grab the pressure gauge body for the purpose of tightening. To tighten, always use a wrench on the hexagonal or square section of the connection port. The tightening torque should be at 294.2N·cm [26.0in.·lbf] or less.

● Panel Mounting Pressure Gauge

■ Panel Mounting Pressure Gauge (GP1-40, GP3-40, GPV-40)

1. When mounting the panel mounting pressure gauge on a panel, machine the mounting holes in accordance with the panel cut dimensions. (See the panel cut dimensions)
2. Since the panel mounting pressure gauge in its packaged condition already has the pressure gauge assembled into the panel mount assembly, always remove the mounting ring from the assembly and then mount on a panel for use.
3. When mounting on a panel, first align the convex section of the back side of the panel mounting case flange to the small hole used for positioning on the panel cut hole (see Figure 1).
4. The tightening torque for the mounting ring used to secure the panel mounting case in position should be 980.7N·cm [86.8in.·lbf] or less.
5. If removing the pressure gauge itself from the panel mounting case, first remove the mounting ring, and then pull up on the tab located on the bottom of the panel mount case. The pressure gauge can now be easily removed by pushing it out. Be aware that forcibly attempting to remove the pressure gauge without first pulling on the tab could damage the convex section inside the tab that is used to prevent falling. (see Figure 2)

■ Panel mounting assembly (PM-40)

If purchasing the pressure gauge and panel mounting assembly separately, take the following steps when combining them to use as the panel mounting pressure gauge.

1. Remove the mounting ring from the panel mounting case, and insert the square part of the pressure gauge connection port into the square part at the bottom of the case.
2. When inserting, check that (1) the two set screws on the back of the pressure gauge case are on the lower side, and (2) two set screw holes are found on the bottom of the panel mounting case's square part. After confirming the above two items, push in the pressure gauge.
3. With the unit in the inserted position, check to see that the convex section at the bottom of the panel mounting case that is used to prevent falling is inserted into the mounting hole (φ 2.3) [0.091in.] at the bottom of the pressure gauge case. If the pressure gauge and panel mounting case have been assembled correctly, the insertion tab will snap smoothly into place. If it does not go in smoothly, lift up on the tab and the unit should then slide in easier (see Figure 3).



(PM-40)

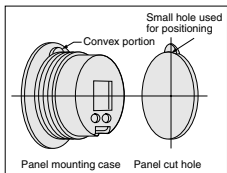

Figure 1

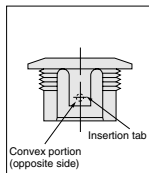

Figure 2

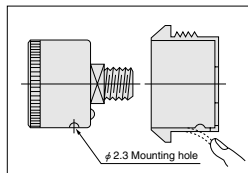

Figure 3

● Small Precision Pressure Gauge

1. The small precision pressure gauge is a pressure indicator designed for more sensitive pressure measurements. Avoid use in locations subject to vibrations or shocks.
2. The throttle valve uses an extremely small orifice for protection from shock pressure transmitted to the Bourdon tube and other internal devices, and is therefore sensitive to intrusions of particles, sludge mist, and other contaminants. For the media, use clean, dry air that has passed through a mist filter, etc.

Preset marker

● Small Pressure Gauge, Pressure Gauge

Preset markers can be used on the pressure gauges G1-40 and G3-40. Rotate the cover ring first to set the low pressure side, and then set the high pressure side.

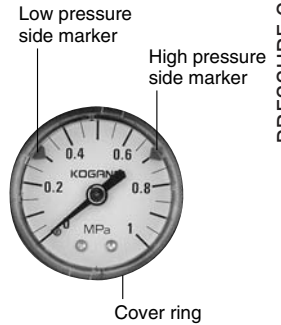

Temperature characteristics

● Small Precision Pressure Gauge

1. The guaranteed temperature accuracy range is 25°C±5 [77±9°F]. Check the ambient temperature of the measurement location before proceeding with measurement.
2. If the temperature is out of the guaranteed temperature accuracy range, perform a pressure compensation by multiplying the ambient temperature by the humidity coefficient 0.05% F.S./°C.
3. In performing pressure compensation, add plus or minus in accordance with temperature characteristics, subtracting when the temperature is at 30°C or higher, and adding when the temperature is at 20°C or lower.

Example: The measured value is 0.2MPa and the ambient temperature is 40°C (the pressure compensation value is ±0.00015MPa)

$$P_0 = P_1 \pm 0.00015 \times (T_1 - T_2)$$

$$= 0.2 - 0.00015 \times 10$$

$$= 0.1985 \text{ MPa}$$

P_0 : Actual pressure (MPa)
 P_1 : Measured pressure (MPa)
 T_1 : Guaranteed accuracy temperature (°C)
 T_2 : Ambient temperature (°C)

※ (Even after performance of pressure compensation, there is an error of ±1% F.S.)

4. If not performing pressure compensation, the pressure indication accuracy value is accurate within the operating temperature range shown on the temperature characteristics graph. Be aware that the ambient temperature can change the indicated accuracy.
5. The graph below positions 25°C [77°F] as the standard temperature, and shows the amount of change from the indicated accuracy at 25°C [77°F] required for the ambient temperature to come within the operating temperature range, in terms of percent of full scale (F.S.).
6. The temperature characteristic lines shown in the graph below are representative examples only. Individual products will exhibit some variance from these lines in terms of characteristics.
7. The chain line ----- shows the indicated accuracy ±1% F.S., while the dotted line shows the amount of change required for the ambient temperature to come within the operating temperature range, calculated using the humidity coefficient. The figures within the framed area □ show the compensation range.

