

Easy-to-use, simple construction valves!
 Suitable for various needs and offering high-performance control, while achieving still lower power consumption, quicker response, and a larger flow rate!

**New
 Standard Valve**

Solenoid Valves JC, JE Series

(2, 3, 5-port pilot type solenoid valves)

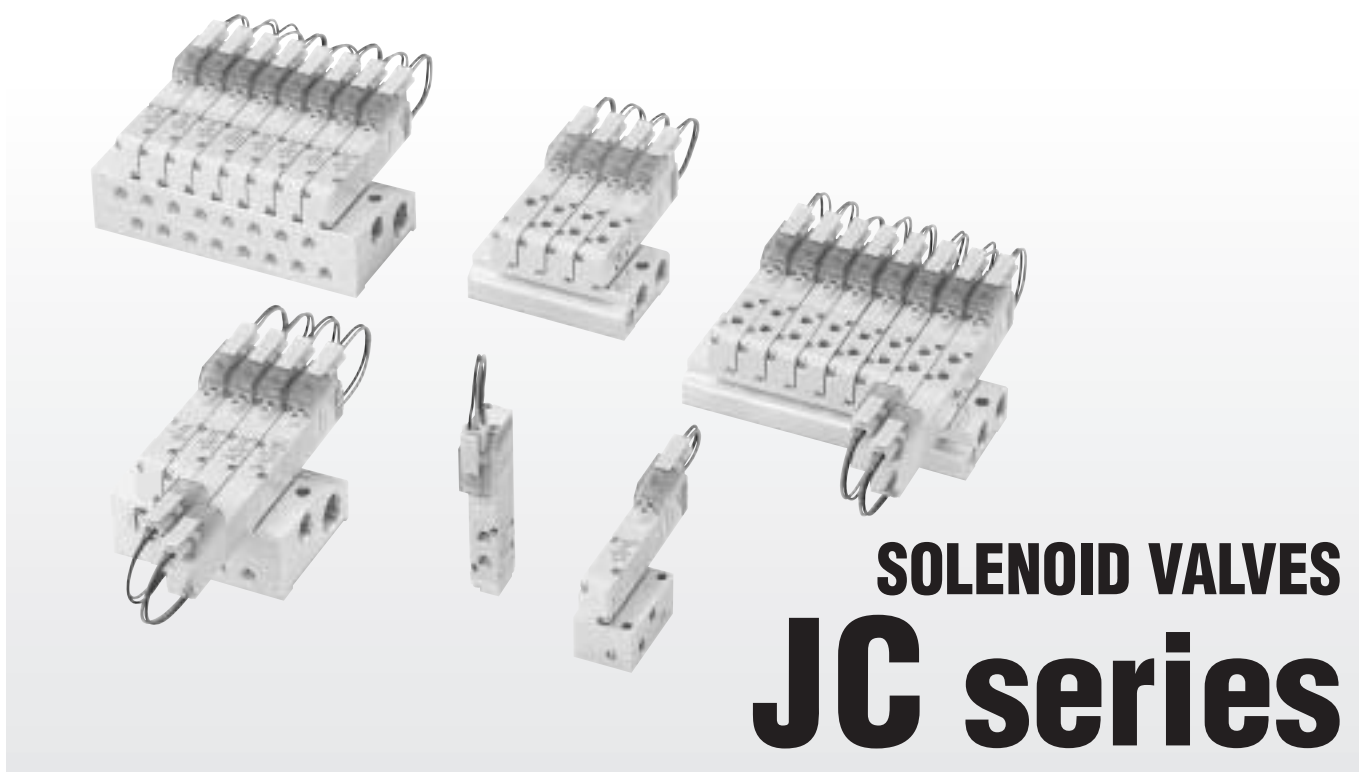

SOLENOID VALVES JC series

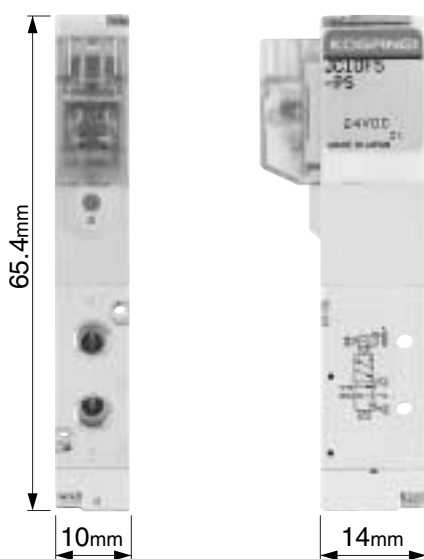

- **Space Saving—Thin and compact size**
 Valve width: 10mm [0.394in.]
 Valve length: 65.4mm [2.575in.]
- **Flow—Large flow rate with a compact body**
 Sonic conductance C: 0.6dm³/(s·bar)
 (Effective area S: 3.0mm² [Cv: 0.17])
 Optimum for operating up to ϕ 40 bore size cylinders.
- **Response—Quick response**
 Response time: When ON, 6ms or below
 When OFF, 7ms or below
 (in the case of quick response type single solenoid)
- **Power—Lower power consumption**
 Standard type: 0.55W, Low current type: 0.15W

Provides sure performance for all situations in which solenoid valves are required, in the manufacturing lines, in machinery, or in equipment. A NEW standard in compact valves!

● **Reliability—Improved reliability**

New solenoid and stem construction resulting for years of valve technology experience have boosted operating life, response, and other basic performance features.

● **Option—Mountable on DIN rail**

The A type manifold (base piping type) can be mounted on a DIN rail.
(for both the JC and JE series)



● **Environmental Protection—Improved performance**

Grommet type valves offer moisture proof specification.

(for both the JC and JE series)

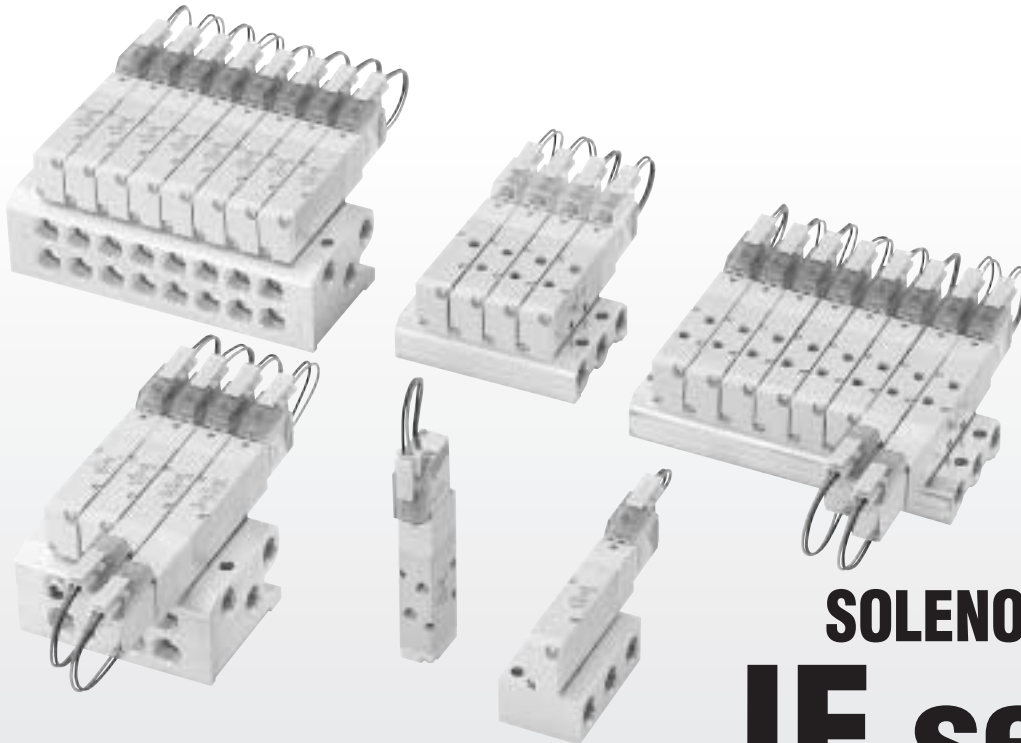

SOLENOID VALVES JE series

SOLENOID VALVES JC, JE SERIES

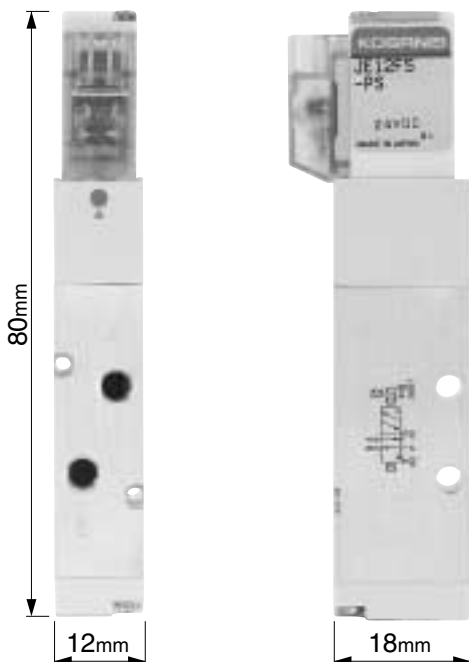

● **Space Saving—Thin and compact size**

Valve width: 12mm [0.472in.]
Valve length: 80mm [3.150in.]

● **Flow—Large flow rate with a compact body**

Sonic conductance C: 1.9dm³/(s·bar)
(Effective area: 9.5mm² [Cv: 0.53])
Optimum for operating up to ϕ 80 bore size cylinders.

● **Response—Quick response**

Response time: When ON, 6ms or below
When OFF, 10ms or below
(for quick response type single solenoid)

● **Power—Lower power consumption**

Standard type: 0.55W, Low current type: 0.15W

● **Safety—Configured to prevent erroneous operations**

Lever type manual override with erroneous operation prevention mechanism improves safety. (JE series only)



—Product Variety—
Provides a wide product range

Solenoid Valves JC Series

Solenoid Valves JE Series

**Single unit
(direct piping)**

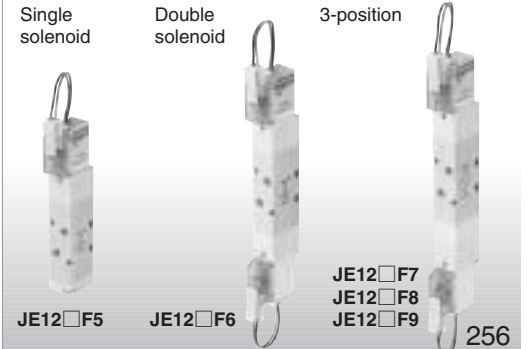
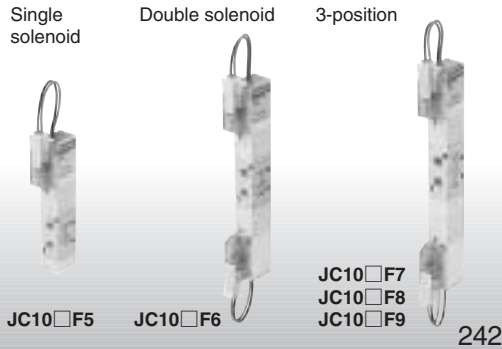

**Single unit
(base piping)**

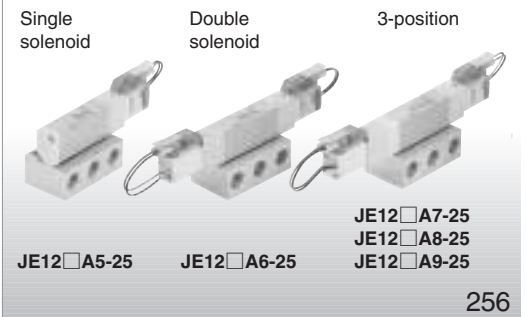
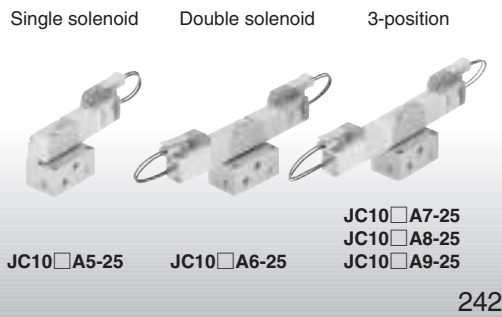

**F type manifold
(direct piping type)**

Manifold for combination mounting of 2, 3, 5-port valves

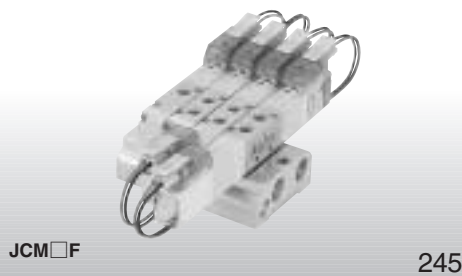

Manifold for combination mounting of 2, 3, 5-port valves

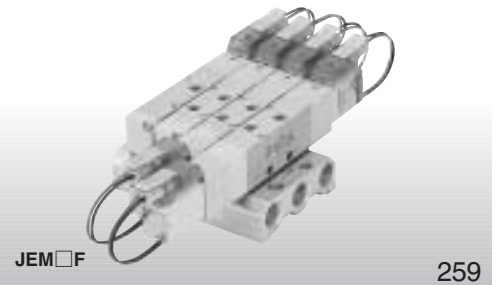

**A type manifold
(base piping type)**

Manifold for combination mounting of 2, 3, 5-port valves

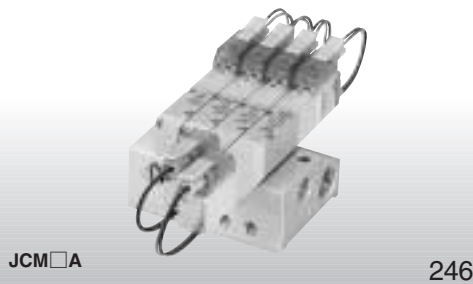

Manifold for combination mounting of 2, 3, 5-port valves

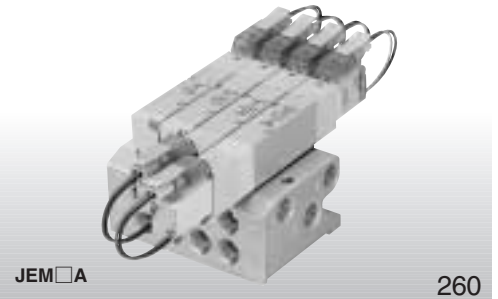

Function-specific solenoids (for both JC and JE series)

● Standard, low current and quick response types can be identified by the color of their housings.

Standard type: Blue



Low current type: Light blue



Quick response type: White





Solenoid

Internal circuit

●DC12V, DC24V

(Standard type)

Solenoid with LED indicator and surge suppression

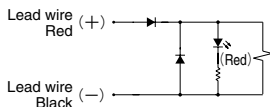

●DC24V

(Low current, quick response types)

Solenoid with LED indicator and surge suppression

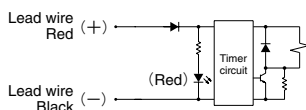

- Cautions:**
1. Do not apply megger between the pins.
 2. Leakage current inside the circuit could result in failure of the solenoid valve to return to the rest position or other erratic operation. Always use it at less than the allowable leakage current shown in the solenoid specifications on p.235, and 249. If circuit conditions, etc. cause the leakage current to exceed the maximum allowable leakage current, consult us.
 3. For the double solenoid configuration, avoid energizing both solenoids simultaneously.
 4. The standard housing type is colored blue, while the low current type is light blue, and the quick response type is white.
 5. The low current and quick response types will not activate when the power supply voltage is raised too slowly. Always apply the appropriate voltage.

Operating principles of low current and quick response types

The low current and quick response types use a timer circuit, as shown above, that achieves power savings by switching to the holding operations mode after a certain period of time and operates at about 1/3 of the starting power consumption.

●Power waveform for low current type

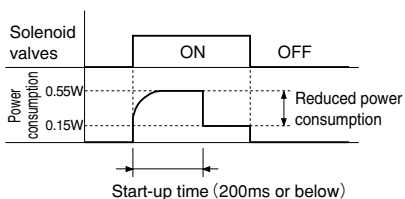

●Power waveform for quick response type

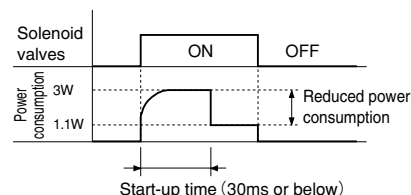

Plug connector

Attaching and removing plug connector

Use fingers to insert the connector into the pin, push it in until the lever claw latches onto the protruded section of the connector housing, and complete the connection. To remove the connector, squeeze the lever along with the connector, lift the lever claw up from the protruded section of the connector housing, and pull it out.

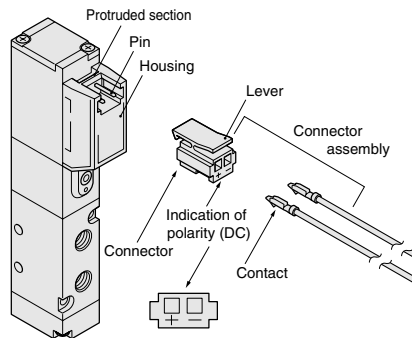

Crimping of connecting lead wire and contact

To crimp lead wires into contacts, strip off 4mm [0.16in.] of the insulation from the end of the lead wire, insert it into the contact, and crimp it. Be sure to avoid catching the insulation on the exposed wire crimping section.

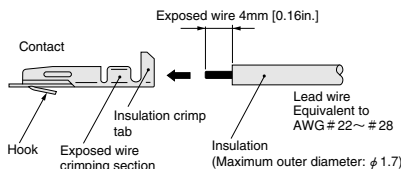

- Cautions:**
1. Do not pull hard on the lead wire.
 2. Always use a dedicated tool for crimping of connecting lead wire and contact.

Contact: Model 702062-2M
Manufactured by Sumiko Tech, Inc.

Crimping tool: Model F1-702062
Manufactured by Sumiko Tech, Inc.

Attaching and removing contact and connector

Insert the contact with lead wire into a plug connector □ hole until the contact hook latches on and is secured to the plug connector. Confirm that the lead wire cannot be easily pulled out.

To remove it, insert a tool with a fine tip (such as a small screwdriver) into the rectangular hole on the side of the plug connector to push up on the hook, and then pull out the lead wire.

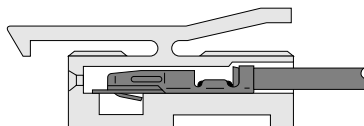

- Cautions:**
1. Do not pull hard on the lead wire. It could result in defective contacts, breaking wires, etc.
 2. If the pin is bent, use a small screwdriver, etc. to gently straighten out the pin, and then complete the connection to the plug connector.



Side mounting precautions (JE series)

When using a JE series single solenoid valve unit in a side mounting, as shown in the diagram below, mounting base -22 for the side mounting is required, because the fitting interferes with the mounting surface. The **TS6-M5** and **TL6-M5** quick fitting standard types for the 6mm tube cannot be mounted. Use the hexagon socket straight fitting or the quick fitting mini type instead.

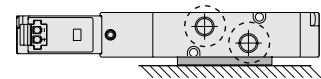

Manual override

Non-locking type

To operate the manual override, press it all the way down.

For the single solenoid, the valve works the same as when in the energized state as long as the manual override is pushed down, and returns to the rest position upon release.

For the double solenoid, pressing the manual override on the 14 (SA) side switches the 14 (SA) to the energized state, and the valve remains in that state even after the manual override is released. To return it to the rest position, operate the manual override on the 12 (SB) side. This is the same for the solenoid 12 (SB).

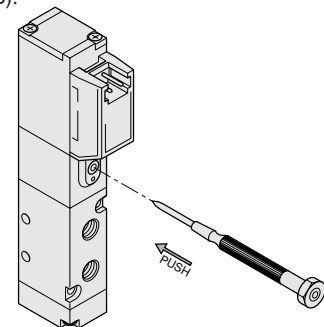

Locking type

To lock the manual override, use a small screwdriver to push down on the manual override all the way down and turn it clockwise 45 degrees. When locked, turning the manual override 45 degrees in the counterclockwise direction returns it to its rest position, and releases the lock. (Excluding the quick response type)

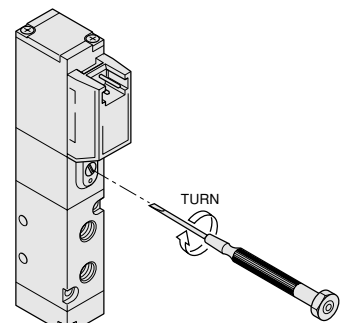

Lever type (JE series only)

To lock the manual override, push the manual lever all the way down and turn it clockwise 90 degrees. When locked, turning the manual lever 90 degrees in the counterclockwise direction returns it to its rest position and releases the lock. When the manual lever is not turned, this type acts just like the non-locking type, and the valve remains in the energized state as long as the manual lever is pushed down, and returns to the rest position upon release.

The manual lever is equipped with a safety plate to avoid erroneous operation. Care should be taken that the safety plate cannot be operated when the manual lever is locked in place.

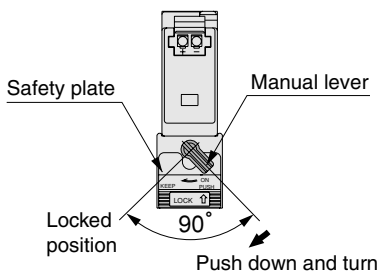

● Safety plate operation

- ① Check that the manual lever is in the off position.
- ② Slide the center of the safety plate in the direction shown by the arrow until it comes to a stop, at a distance of about 3mm [0.12in.]. In this position, the manual lever can no longer be pushed in.
- ③ To release the safety plate, slide it in the direction opposite to that shown by the arrow until it comes to a stop.

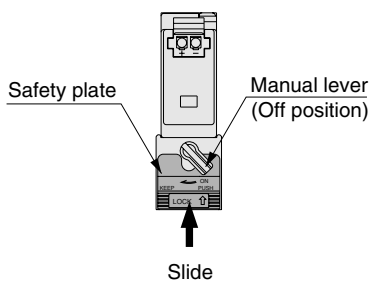

- Cautions:**
1. The JC and JE series are pilot type solenoid valves. As a result, the manual override button or manual lever cannot switch the main valve without air supplied from the 1(P) port.
 2. Always release the lock of the manual override button or manual lever before commencing normal operation.
 3. Do not attempt to operate the manual override button or manual lever with a pin or other object having an extremely fine tip. It could damage the button.
 4. For the lever type, do not apply excessive force when sliding the safety plate. It could result in a breakdown. (Recommended force: 3N)

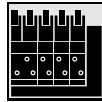

Manifold

Mounting on a DIN rail (A type manifold)

With the DIN rail mounting bracket option, a mounting bracket and mounting screw are provided. First, use the mounting screw to temporarily secure the mounting bracket on the manifold.

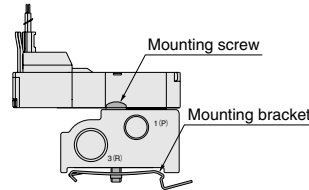

● Mounting

- ① Approaching from the direction shown in the diagram, let the mounting bracket hook latch onto the DIN rail fringe, then press down the manifold to secure the bracket onto the DIN rail.

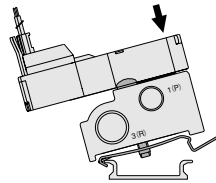

- ② To ensure that the mounting bracket is firmly set against the bottom of the manifold, tighten the mounting screw to secure the DIN rail in place. Recommended tightening torque: 98N·cm {10kgf·cm} [8.7in·lbf]

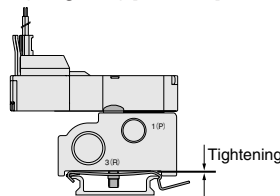

Caution: Since the mounting bracket cannot slide along the DIN rail once it is set onto the rail, make sure to set the manifold in the appropriate position beforehand.

● Removing

- ① Loosen the mounting screw and lift the manifold off and away from the mounting bracket.
- ② Insert a flatblade screwdriver, etc. underneath the mounting bracket's release lever, and gently pry it away to remove the mounting bracket.

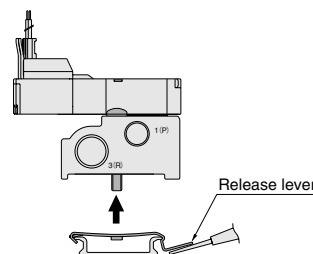

Cautions: Spring force from the mounting bracket's plate could cause the bracket to pop out during the removal operation. To ensure safety, proceed with caution during the operation. In addition, always use a flatblade screwdriver, etc. when removing the mounting bracket from the DIN rail. Never use your fingers because of the danger of serious injury due to the potential strong forces.

● Vertical mounting

When mounting the manifold in a vertical direction, mount it so that the release lever is pointing downward.

Caution: Caution should be taken not to drop the manifold.

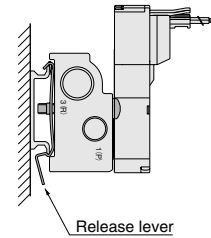

Mounting a valve on the manifold

When mounting a valve on the manifold, the recommended tightening torque for the valve mounting screw is 14.7N·cm {1.5kgf·cm} [1.30in·lbf].

Tube

1. Attaching and removing tubes

For tube connection, insert an appropriate size tube until it comes into contact with the tube stopper, and lightly pull it to check the connection.

For tube removal, push the tube against the tube stopper, then push the release ring and at the same time pull the tube out.

2. Either a nylon or urethane tube can be used.

Use tubes with an outer diameter tolerance within $\pm 0.1\text{mm}$ [$\pm 0.004\text{in.}$] of the nominal diameter, and ensure the ovalness (difference between large diameter and small diameter) is 0.2mm [0.008in.] or less. (Using Koganei tubes is recommended.)

- Cautions:**
1. Do not use extra-soft tubes since their pull-out strength is significantly reduced.
 2. Only use tubes without scratches on their outer surfaces. If a scratch occurs during repeated use, cut off the scratched section.
 3. Do not bend the tube excessively near the fittings. The minimum bending radius is as shown in the table below.
 4. When attaching or removing tubes, always stop the air supply. In addition, always confirm that air has been completely exhausted from the manifold.

Tube size	Minimum bending radius	
	Nylon tube	Urethane tube
φ3	—	7 [0.28]
φ4	20 [0.79]	10 [0.39]
φ6	30 [1.18]	15 [0.59]
φ8	50 [1.97]	20 [0.79]

Solenoid Valves JE Series

JE

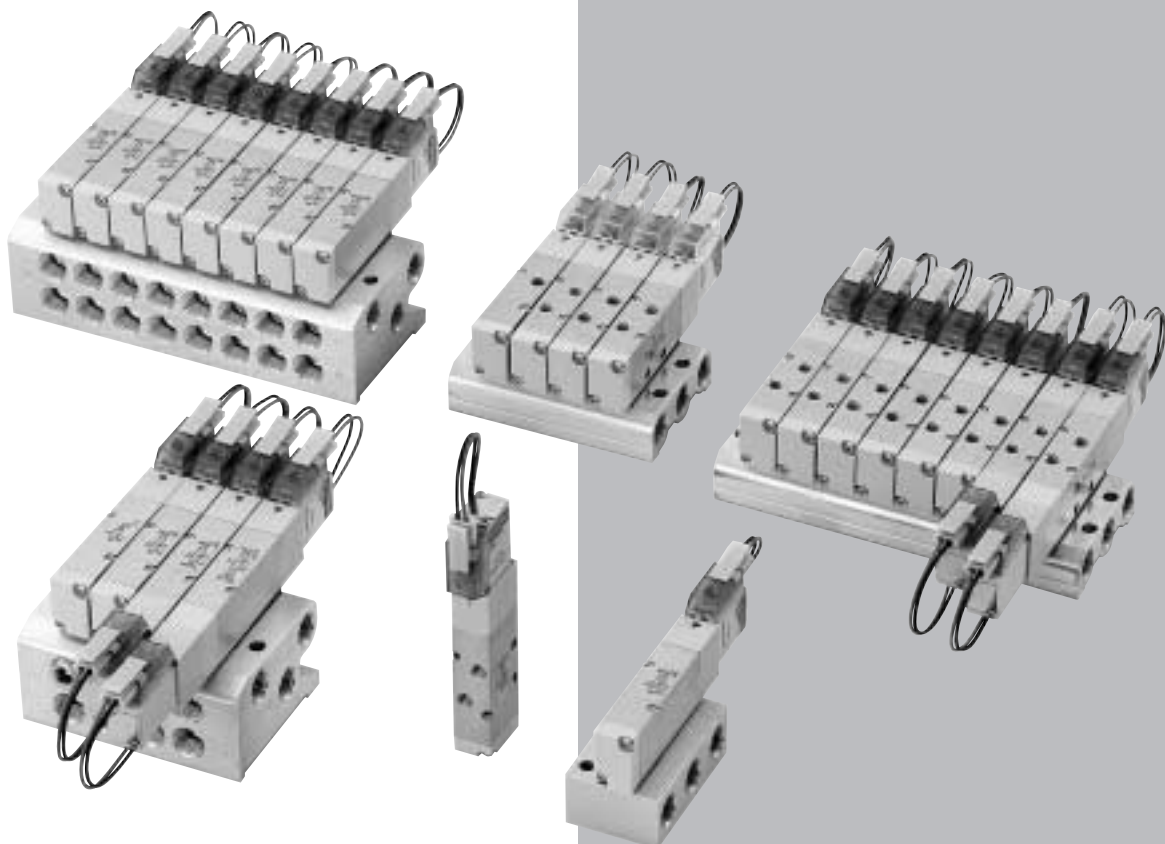

SOLENOID VALVES JC, JE SERIES

JE SERIES SPECIFICATIONS

Specifications

Basic Models and Functions

Basic model	For direct piping, F type manifolds	JE12□F1 ^{Note} JE12□F2 ^{Note} JE12□F3 ^{Note} JE12□F4 ^{Note}	JE12□F5	JE12□F6	JE12□F7 JE12□F8 JE12□F9
	For base piping, A type manifolds	JE12□A1 ^{Note} JE12□A2 ^{Note} JE12□A3 ^{Note} JE12□A4 ^{Note}	JE12□A5	JE12□A6	JE12□A7 JE12□A8 JE12□A9
Item					
Number of positions		2 positions			3 positions
Number of ports		2, 3 ports	5 ports		
Valve function		Single solenoid NC, NO	Single solenoid	Double solenoid	Closed center, Exhaust center, Pressure center

Remark: For the optional specifications and order codes, see p.253.

Note: Valves with valve specifications F1, F2, F3, F4, A1, A2, A3, and A4 are for mounting on manifolds only, and cannot be used as single valve units.

Specifications

Basic model	For direct piping, F type manifolds	JE12□F1 JE12□F2 JE12□F3 JE12□F4	JE12□F5	JE12□F6	JE12□F7 JE12□F8 JE12□F9
	For base piping, A type manifolds	JE12□A1 JE12□A2 JE12□A3 JE12□A4	JE12□A5	JE12□A6	JE12□A7 JE12□A8 JE12□A9
Item					
Media		Air			
Operation type		Internal pilot type			
Flow rate characteristics ^{Note 1} Sonic conductance C dm ³ /(s · bar)		Base piping (A type): 1.9			
Port size ^{Note 2}		Direct piping (F type): M5×0.8, Base piping (A type): Rc1/8			
Lubrication		Not required			
Operating pressure range MPa {kgf/cm ² }[psi.]		0.2~0.7 {2~7.1} [29~102]			
Proof pressure MPa {kgf/cm ² }[psi.]		1.05 {10.7} [152]			
Response time ^{Note 3} ON/OFF	ms	Standard type	12/28 or below	20 or below	12/30 or below
		Low current type (L)	12/60 or below	20 or below	12/60 or below
		Quick response type (S)	6/10 or below	8 or below	6/10 or below
Maximum operating frequency	Hz	Standard type	5		
		Low current type (L)	2		
		Quick response type (S)	10		
Minimum time to energize for self holding ^{Note 4}		ms	—	50	—
Operating temperature range (atmosphere and media)		°C [°F] 5~50 [41~122]			
Shock resistance		m/s ² {G}	1373.0 {140} (Axial direction 294.2 {30})	1373.0 {140} (Axial direction 245.0 {25})	
Mounting direction		Any			

Notes: 1. For details, see the flow rate characteristics on p.250.

2. For details, see the port size on p.251.

3. Values when air pressure is 0.5MPa [73psi.]. The values for the 3-position valves are the switching time from the neutral position.

4. For double solenoid valve.

Solenoid Specifications

Item	Rated voltage	DC12V (Standard type)		DC24V (Standard type)		DC24V (Low current type)		DC24V (Quick response type)	
Operating voltage range		V		10.8~13.2 (12±10%)	21.6~26.4 (24±10%)	21.6~26.4 (24±10%)	21.6~26.4 (24±10%)	21.6~26.4 (24±10%)	
Standard type	Current (when rated voltage is applied)	mA (r.m.s)		46	23	—	—	—	
	Power consumption	W		0.55	0.55	—	—	—	
Low current type Quick response type	Current (when rated voltage is applied)	Starting	mA	—	—	23	—	125	
		Holding	mA	—	—	6.3	—	46	
	Power consumption	Starting	W	—	—	0.55	—	3	
		Holding	W	—	—	0.15	—	1.1	
Start-up time (standard time)		ms		—	—	200 or below		30 or below	
Allowable leakage current		mA		2	1	0.5		4	
Insulation resistance		MΩ		Over 100 (value at DC500V megger)					
Color of LED indicator		Red							
Surge suppression (as standard)		Flywheel diode							

Flow Rate Characteristics

The test method for flow rate characteristics conforms to JIS B 8390:2000 (test method for pneumatic equipment — equipment for compressible fluids — flow rate characteristics).

● When used as a single unit (with fittings)

Basic model		Flow path	Sonic conductance C dm ³ /(s·bar)	Critical pressure ratio b	Effective area S ^{Note 5} mm ² [Cv]	
Direct piping ^{Note 1}	JE12□F5	1 (P) → 4 (A)	0.81	0.55	4.05 [0.225]	
		1 (P) → 2 (B)	0.81	0.54	4.05 [0.225]	
		4 (A) → 5 (R1)	0.75	0.44	3.75 [0.208]	
	JE12□F6	2 (B) → 3 (R2)	0.76	0.43	3.80 [0.211]	
		JE12□F7	1 (P) → 4 (A)	0.80	0.51	4.00 [0.222]
			JE12□F8	1 (P) → 2 (B)	0.80	0.52
	4 (A) → 5 (R1)			0.71	0.41	3.55 [0.197]
	JE12□F9	2 (B) → 3 (R2)	0.72	0.43	3.60 [0.200]	
		Base piping ^{Note 2} (with sub-base)	JE12□A5	1 (P) → 4 (A)	1.91	0.19
1 (P) → 2 (B)	1.93			0.18	9.65 [0.536]	
4 (A) → 5 (R1)	1.90			0.15	9.50 [0.528]	
JE12□A6	2 (B) → 3 (R2)		1.90	0.12	9.50 [0.528]	
	JE12□A7		1 (P) → 4 (A)	1.42	0.20	7.10 [0.394]
			JE12□A8	1 (P) → 2 (B)	1.49	0.21
4 (A) → 5 (R1)				1.37	0.18	6.85 [0.381]
JE12□A9	2 (B) → 3 (R2)		1.28	0.14	6.40 [0.356]	

● When mounted on a manifold (with fittings)

Basic model		Flow path	Sonic conductance C dm ³ /(s·bar)	Critical pressure ratio b	Effective area S ^{Note 5} mm ² [Cv]	
F type manifold ^{Note 3} (direct piping type)	JE12□F1	1 (P) → 4 (A)	0.88	0.64	4.40 [0.244]	
		1 (P) → 2 (B)	0.88	0.63	4.40 [0.244]	
	JE12□F2	4 (A) → 5 (R1)	0.90	0.20	4.50 [0.250]	
		JE12□F3	2 (B) → 3 (R2)	0.91	0.20	4.55 [0.253]
	JE12□F4		1 (P) → 4 (A)	0.84	0.59	4.20 [0.233]
		JE12□F5	1 (P) → 2 (B)	0.85	0.59	4.25 [0.236]
	JE12□F6		4 (A) → 5 (R1)	0.85	0.20	4.25 [0.236]
		JE12□F7	2 (B) → 3 (R2)	0.85	0.21	4.25 [0.236]
	A type manifold ^{Note 4} (base piping type)		JE12□A1	1 (P) → 4 (A)	1.62	0.38
		1 (P) → 2 (B)		1.63	0.38	8.15 [0.453]
JE12□A2		4 (A) → 5 (R1)	1.82	0.10	9.10 [0.506]	
		JE12□A3	2 (B) → 3 (R2)	1.77	0.18	8.85 [0.492]
JE12□A4			1 (P) → 4 (A)	1.34	0.40	6.70 [0.372]
		JE12□A5	1 (P) → 2 (B)	1.37	0.24	6.85 [0.381]
JE12□A6			4 (A) → 5 (R1)	1.34	0.08	6.70 [0.372]
		JE12□A7	2 (B) → 3 (R2)	1.26	0.17	6.30 [0.350]

- Notes: 1. Quick fitting TSH6-M5Ms are mounted on connection ports 1(P), 2(B), and 4(A).
 2. Quick fitting TS8-01s are mounted on connection ports 1(P), 2(B), and 4(A).
 3. Quick fitting TSH6-M5Ms are mounted on connection ports 2(B) and 4(A).
 4. Quick fitting TS6-01Ms are mounted on connection ports 2(B) and 4(A).
 5. Figures in effective area S are calculated based on sonic conductance C ($S=5.0 \times C$).

Base piping type
(Effective area S = 9.5mm² [Cv: 0.53])

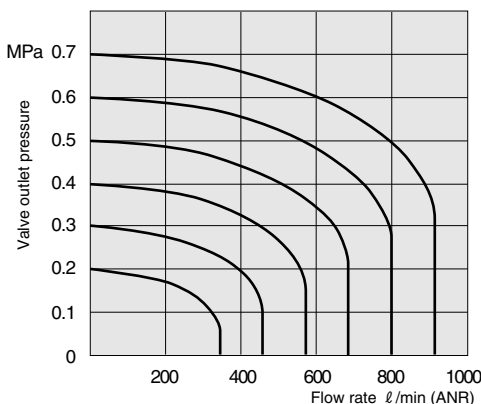

Direct piping type
(Effective area S = 4.4mm² [Cv: 0.25])

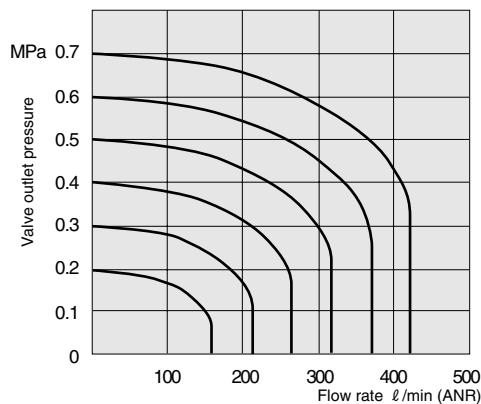

1MPa = 145psi., 1 l / min = 0.0353ft³/min

- Graphs use flow rate calculations based on the discharge method.
- Use the flow rate as a guide.

Port Size

Port specification	Port	2(B), 4(A)	1(P)	3, 5(R)
Single unit	Direct piping	M5×0.8	M5×0.8	M5×0.8
	Base piping (with sub-base)	Rc1/8	Rc1/8	Rc1/8
Manifold	F type	M5×0.8	Rc1/8	Rc1/8
	A type	Rc1/8	Rc1/8	Rc1/8

Mass

Single Valve Unit Mass

g [oz.]

Basic model	Mass	Additional mass		
		-21 (with bottom mounting base)	-22 (with side mounting base)	-25 (with sub-base)
JE12□F1	39 [1.38]	—	—	—
JE12□F2				
JE12□F3				
JE12□F4				
JE12□F5	36 [1.27]	6 [0.21]	5 [0.18]	—
JE12□F6	52 [1.83]			
JE12□F7	55 [1.94]	—	5 [0.18]	—
JE12□F8				
JE12□F9				
JE12□A1	39 [1.38]	—	—	—
JE12□A2				
JE12□A3				
JE12□A4				
JE12□A5	36 [1.27]	—	—	48 [1.69]
JE12□A6	52 [1.83]			
JE12□A7	55 [1.94]			
JE12□A8				
JE12□A9				

Manifold Mass

g [oz.]

Basic model	Mass calculation of each unit (n = number of units)	Block-off plate	With DIN rail mounting bracket
JEM□F	$(13 \times n) + 17$ [(0.46×n)+0.60]	7 [0.25]	—
JEM□A	$(32 \times n) + 59$ [(1.13×n)+2.08]		15 [0.53]

Calculation example: **JEM8A**

stn.1~8 JE12A5-PS-D4

$$(32 \times 8) + 59 + (36 \times 8) = 603\text{g} [21.27\text{oz.}]$$

5-port, 2-position

Single solenoid

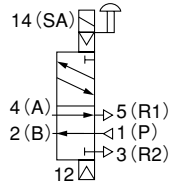

JE12F5

De-energized

Double solenoid

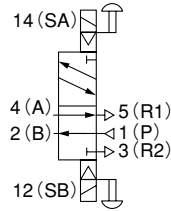

JE12F6

[De-energized condition after energizing solenoid 12 (SB)]

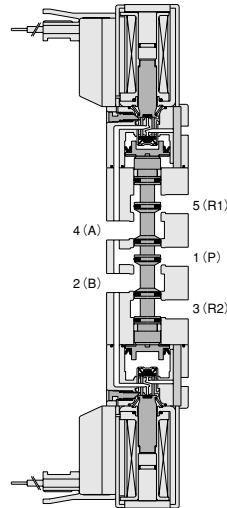
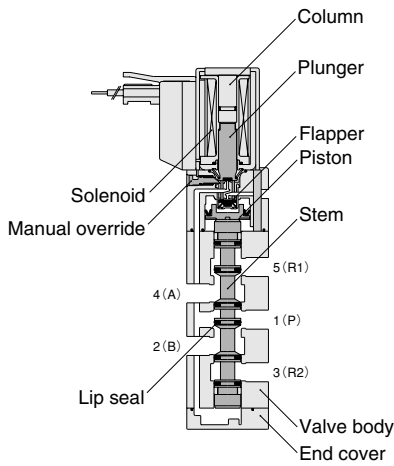

Major Parts and Materials

Parts	Materials
Body	Aluminum alloy
Stem	(anodized)
Lip seal	Synthetic rubber
Flapper	
Valve	Mounting base Mild steel (nickel plated)
	Sub-base Aluminum alloy (anodized)
	Plunger Magnetic stainless steel
	Column
	End cover Plastic
Manifold	Body Aluminum alloy (anodized)
	Block-off plate Mild steel (nickel plated)
	Seal Synthetic rubber

SOLENOID VALVES JC, JE SERIES

5-port, 3-position

[Both 14 (SA) and 12 (SB) are de-energized]

Closed center

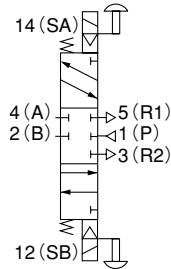

JE12F7

Exhaust center

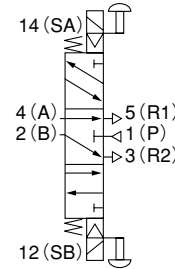

JE12F8

Pressure center

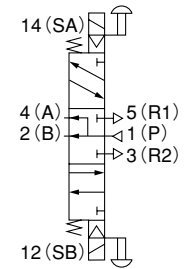

JE12F9

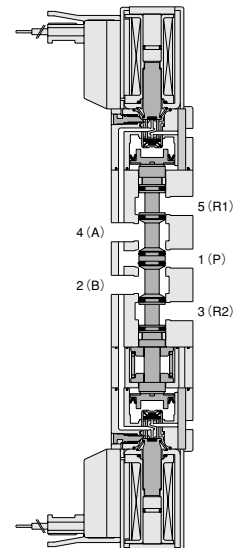
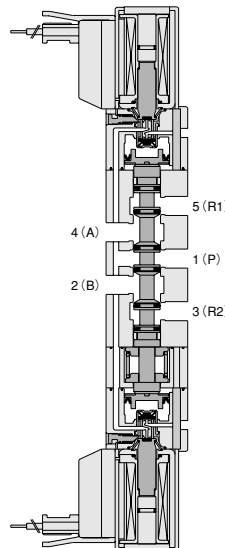
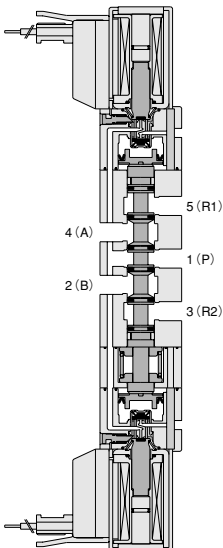

JE Series Single Valve Unit Order Codes



Valve specification

- F1, A1: 2-port normally closed (NC)^{Note1}
- F2, A2: 2-port normally open (NO)^{Note1}
- F3, A3: 3-port normally closed (NC)^{Note1}
- F4, A4: 3-port normally open (NO)^{Note1}
- F5, A5: 5-port 2-position, single solenoid
- F6, A6: 5-port 2-position, double solenoid
- F7, A7: 3-position, closed center
- F8, A8: 3-position, exhaust center
- F9, A9: 3-position, pressure center

Model

- JE12**
Standard type
- JE12L**
Low current type
- JE12S**
Quick response type

Mounting base

Without mounting base

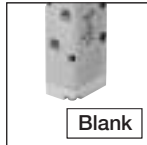

Blank

With mounting base (for bottom mounting)



-21

With mounting base (for side mounting)



-22

Mounting base for side mounting is supplied with a valve.

Sub-base

Without sub-base



Blank

With sub-base

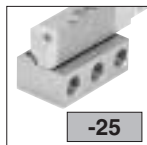

-25

Muffler

Without muffler

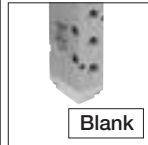

Blank

With muffler for direct piping^{Note2}

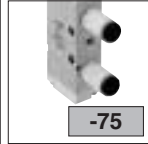

-75

With muffler for sub-base piping^{Note3}

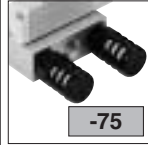

-75

Manual override

Non-locking type

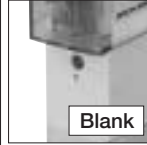

Blank

Locking type^{Note4}



-81

Lever type (with erroneous operation prevention mechanism)



-84

Wiring specification

S type plug connector
Lead wire 300mm

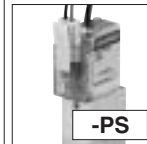

-PS

L type plug connector
Lead wire 300mm

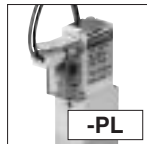

-PL

S type plug connector
Lead wire 1000mm

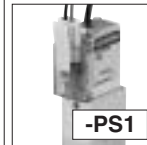

-PS1

L type plug connector
Lead wire 1000mm

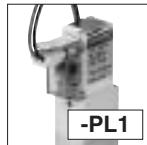

-PL1

S type plug connector
Lead wire 3000mm

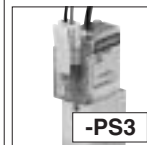

-PS3

L type plug connector
Lead wire 3000mm

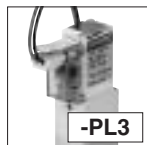

-PL3

S type plug connector
Without connector ass'y



-PSN

L type plug connector
Without connector ass'y

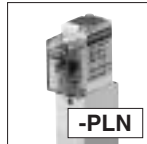

-PLN

Grommet type^{Note5}
Lead wire 300mm
(moisture proof specification)



-GL

Voltage

-D4

DC24V

-D5

DC12V^{Note6}

300mm = [11.8in.]
1000mm = [39in.]
3000mm = [118in.]

	Model	Valve specification	Mounting base	Sub-base	Muffler	Manual override	Wiring specification	Voltage
Direct piping	JE12 JE12L JE12S	F1 ^{Note1} F2 ^{Note1} F3 ^{Note1} F4 ^{Note1}	Blank -21 -22		Blank -75 ^{Note2}	Blank -81 ^{Note4} -84	-PS -PS1 -PS3 -PSN -PL -PL1 -PL3 -PLN -GL ^{Note5}	-D4 -D5 ^{Note6}
		F5	Blank -22					
		F6 F7 F8 F9	Blank -22					
Base piping	JE12 JE12L JE12S	A1 ^{Note1} A2 ^{Note1} A3 ^{Note1} A4 ^{Note1}				Blank -81 ^{Note4} -84	-PS -PS1 -PS3 -PSN -PL -PL1 -PL3 -PLN -GL ^{Note5}	-D4 -D5 ^{Note6}
		A5		Blank -25	Blank -75 ^{Note3}			
		A6 A7 A8 A9						

Notes: 1. Valves with valve specifications F1, F2, F3, F4, A1, A2, A3, and A4 are for mounting on manifolds only, and cannot be used as single valve units.

2. The muffler thread for direct piping is M5X0.8 and the muffler cannot be used for sub-base piping.
3. When ordering the sub-base piping with muffler, always enter both -25 (sub-base) and -75 (muffler). The muffler thread for sub-base piping is Rc1/8 and the muffler cannot be used for direct piping.

4. The locking-type manual override is not available in the quick response type JE12S.

5. The grommet type is not available in the low current type JE12L and quick response type JE12S.

6. The DC12V specification is not available in the low current type JE12L and quick response type JE12S.

JE Series Manifold Order Codes

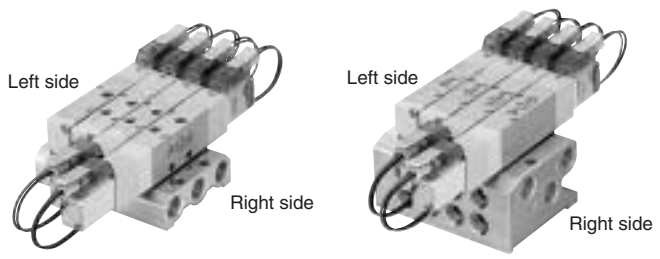

Manifold specification

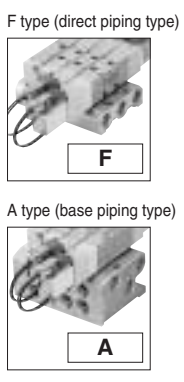

Mounting type

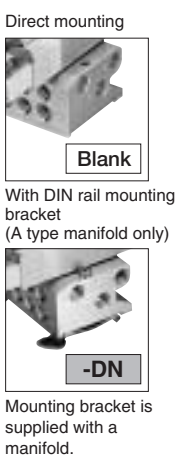

Valve specification

- F1, A1:** 2-port normally closed (NC)
- F2, A2:** 2-port normally open (NO)
- F3, A3:** 3-port normally closed (NC)
- F4, A4:** 3-port normally open (NO)
- F5, A5:** 5-port 2-position, single sol.
- F6, A6:** 5-port 2-position, double sol.
- F7, A7:** 3-position, closed center
- F8, A8:** 3-position, exhaust center
- F9, A9:** 3-position, pressure center

Manual override

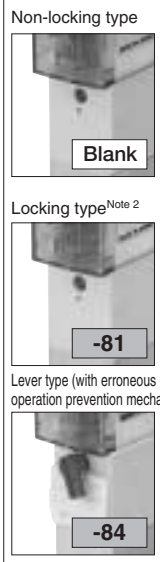

Wiring specification

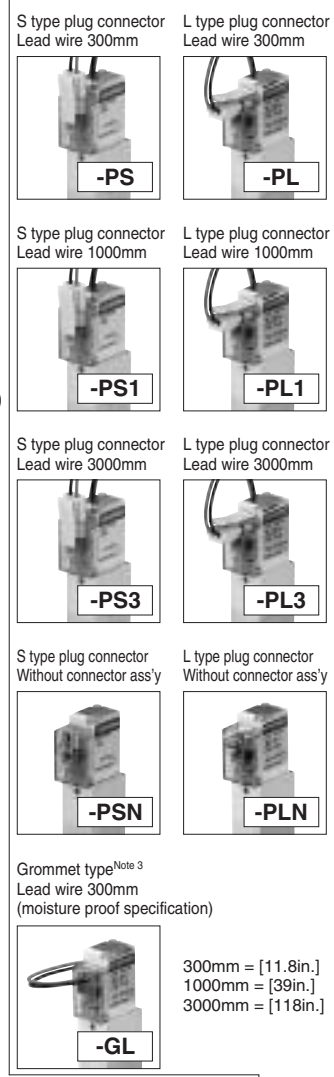

Voltage

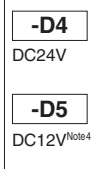

Model

- JE12**
Standard type
- JE12L**
Low current type
- JE12S**
Quick response type

Model	Number of units	Manifold specification	Mounting type	Station	Model	Valve specification	Manual override	Wiring specification	Voltage
-------	-----------------	------------------------	---------------	---------	-------	---------------------	-----------------	----------------------	---------

Manifold model				Mounting valve model					
F type manifold (direct piping type)	JEM	2 20	F	stn.1 . . . stn.□ Note1	JE12 JE12L JE12S	F1 F2 F3 F4 F5 F6 F7 F8 F9	Blank -81 ^{Note2} -84	-PS -PS1 -PS3 -PSN -PL -PL1 -PL3 -PLN -GL ^{Note3}	-D4 -D5 ^{Note4}
			JEBP (for block-off plate)						
A type manifold (base piping type)	JEM	2 20	A	stn.1 . . . stn.□ Note1	JE12 JE12L JE12S	A1 A2 A3 A4 A5 A6 A7 A8 A9	Blank -81 ^{Note2} -84	-PS -PS1 -PS3 -PSN -PL -PL1 -PL3 -PLN -GL ^{Note3}	-D4 -D5 ^{Note4}
			JEBP (for block-off plate)						

Notes: 1. The valve mounting location is from the left side of the manifold.
 2. The locking-type manual override is not available in the quick response type JE12S.
 3. The grommet type is not available in the low current type JE12L and quick response type JE12S.
 4. The DC12V specification is not available in the low current type JE12L and quick response type JE12S.

SOLENOID VALVES JC, JE SERIES

JE Series Additional Parts Order Codes

Block-off plate (block-off plate and 2 mounting screws)

JEBP

Connector-related

EAZ -

Connector specification

- P** : Connector, lead wire length 300mm [11.8in.]
- P1** : Connector, lead wire length 1000mm [39in.]
- P3** : Connector, lead wire length 3000mm [118in.]
- PN** : Connector, without lead wire (contacts included)

DIN rail mounting bracket (with screws)

JEZ -DN



Common connector assembly

EAZ -

Connector specification

- PA** : Positive common A type, connector, lead wire length 300mm [11.8in.]
- PA1** : Positive common A type, connector, lead wire length 1000mm [39in.]
- PA3** : Positive common A type, connector, lead wire length 3000mm [118in.]
- PB** : Positive common B type, connector, lead wire length 300mm [11.8in.]
- PB1** : Positive common B type, connector, lead wire length 1000mm [39in.]
- PB3** : Positive common B type, connector, lead wire length 3000mm [118in.]
- PC** : Positive common C type, connector, lead wire length 300mm [11.8in.]
- PC1** : Positive common C type, connector, lead wire length 1000mm [39in.]
- PC3** : Positive common C type, connector, lead wire length 3000mm [118in.]
- CPN** : Positive common, connector, without lead wire (short bar and contacts included)

A type: EAZ-PA ※



B type: EAZ-PB ※

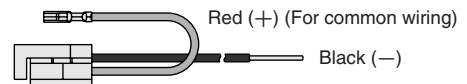

C type: EAZ-PC ※

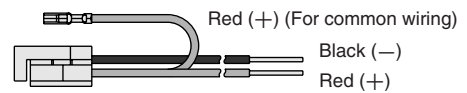

※Lead wire length

Blank : 300mm [11.8in.]
1 : 1000mm [39in.]
3 : 3000mm [118in.]

Application example

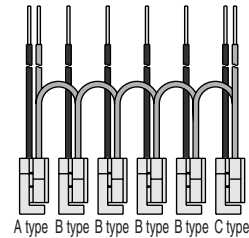

Dimensions of JE Series Single Valve Unit (mm)

5-port, single solenoid JE12□F5-PL

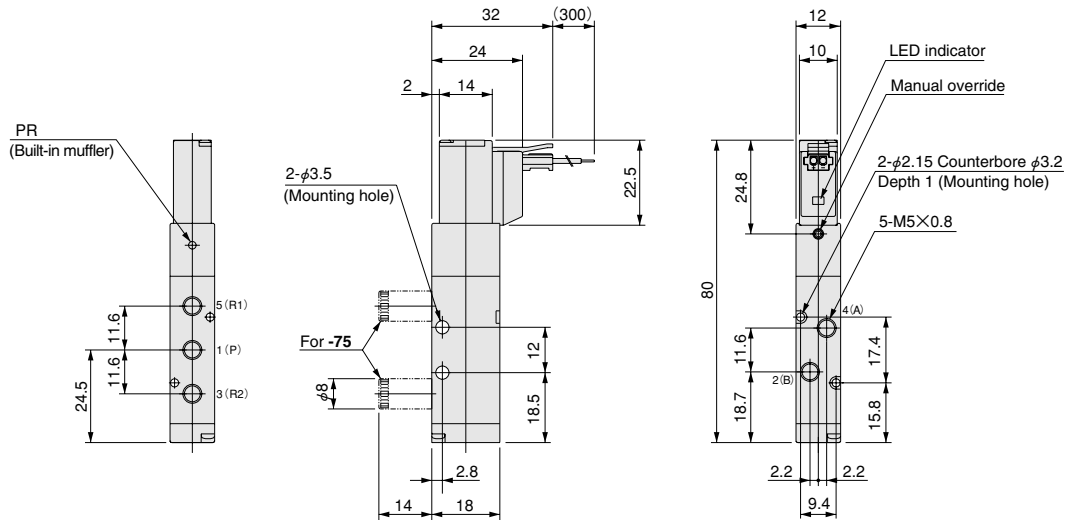

5-port, single solenoid (with sub-base) JE12□A5-25-PL

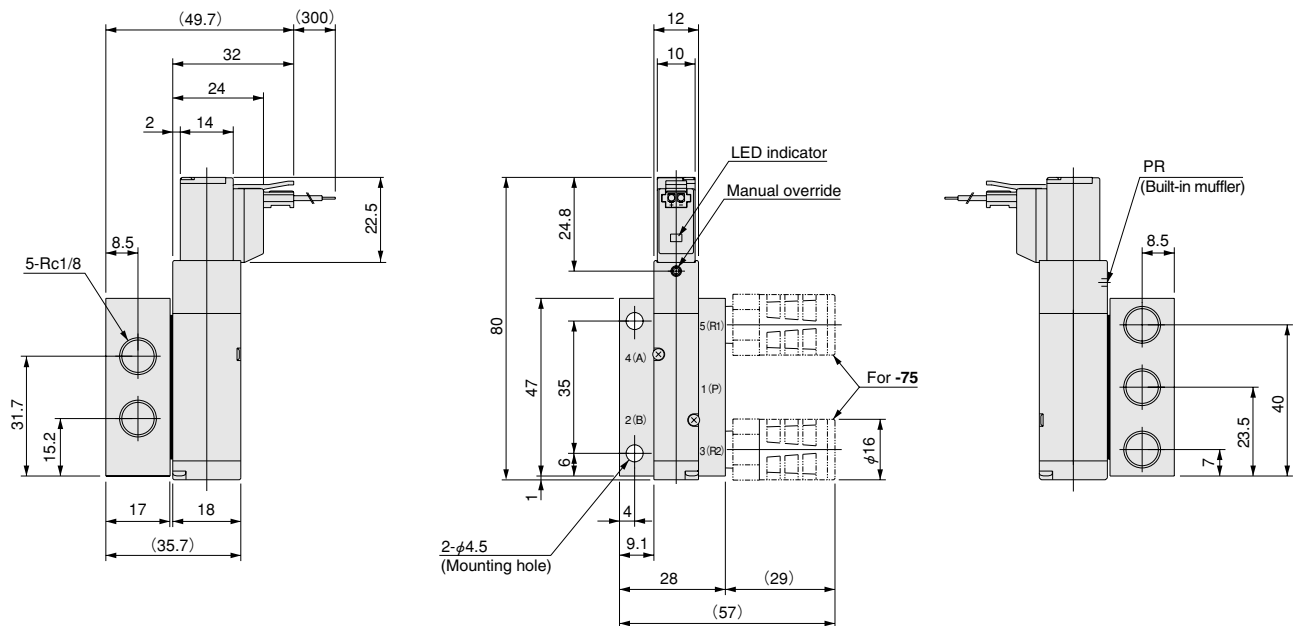

Options

● Mounting base: -21

● Mounting base: -22
(for side mounting)

● Locking type manual override: -81

● Grommet: -GL

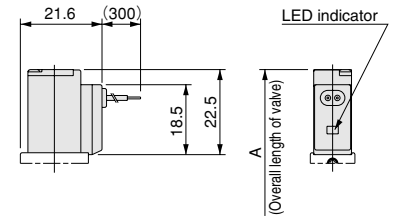
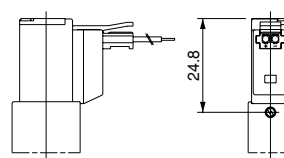
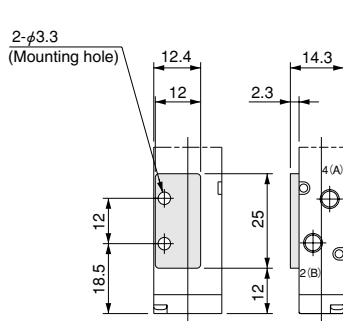
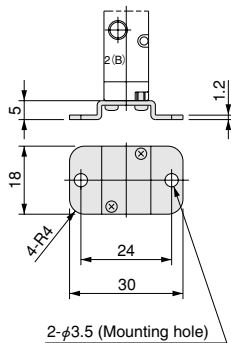

● Lever type manual override: -84

● S type plug connector: -PS

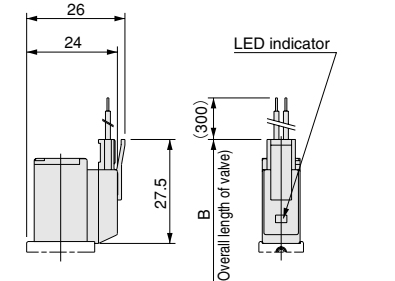
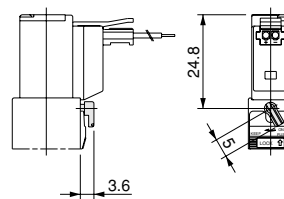

Model	Code	A	B	Remark
JE12F5, JE12A5		80	85	Overall length to the end of the valve
JE12LF5, JE12LA5, JE12SF5, JE12SA5		—	85	

Dimensions of JE Series Single Valve Unit (mm)

5-port, double solenoid JE12□F6-PL

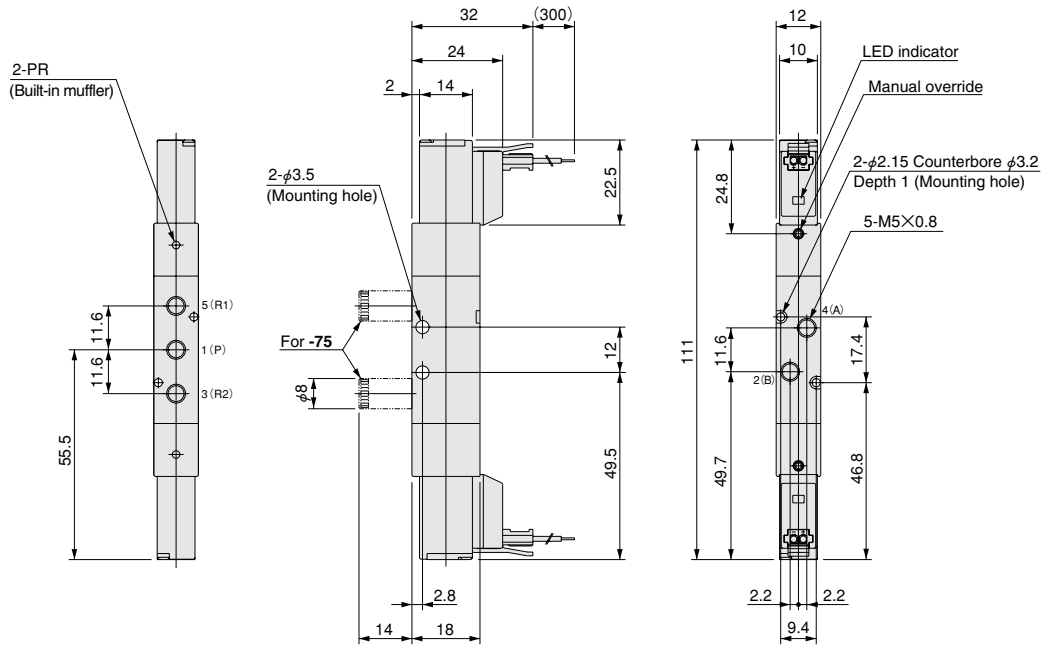

5-port, double solenoid (with sub-base) JE12□A6-25-PL

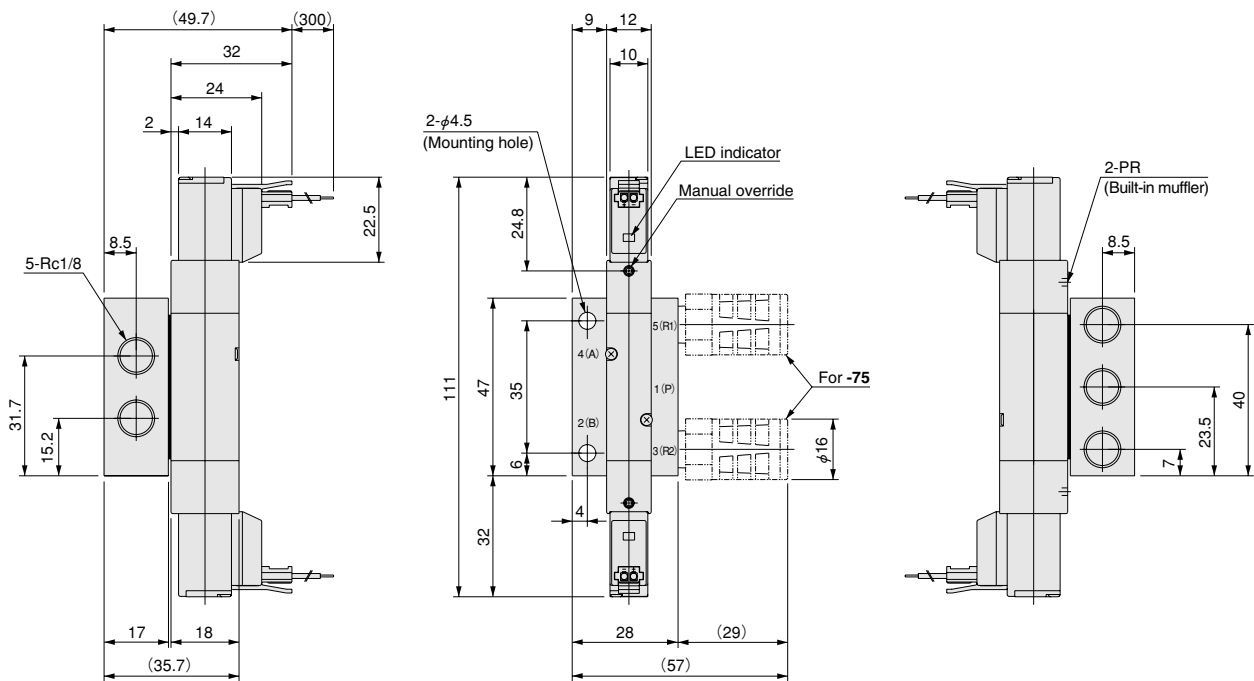

Dimensions of JE Series Single Valve Unit (mm)

5-port, 3-position

JE12□F7-PL

JE12□F8-PL

JE12□F9-PL

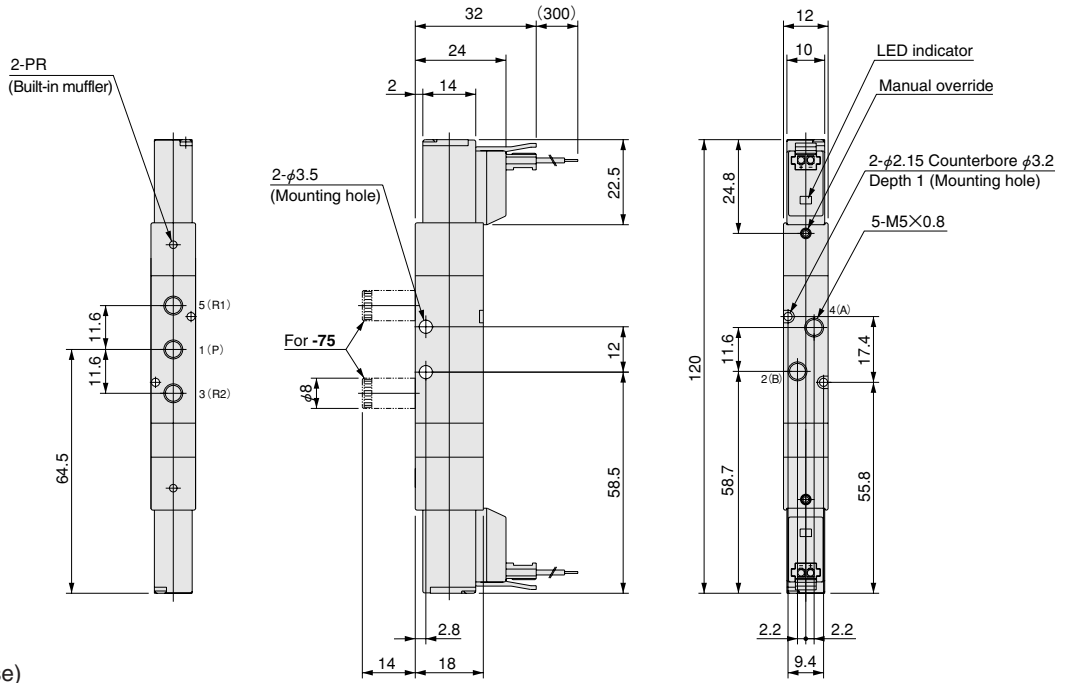

5-port, 3-position (with sub-base)

JE12□A7-25-PL

JE12□A8-25-PL

JE12□A9-25-PL

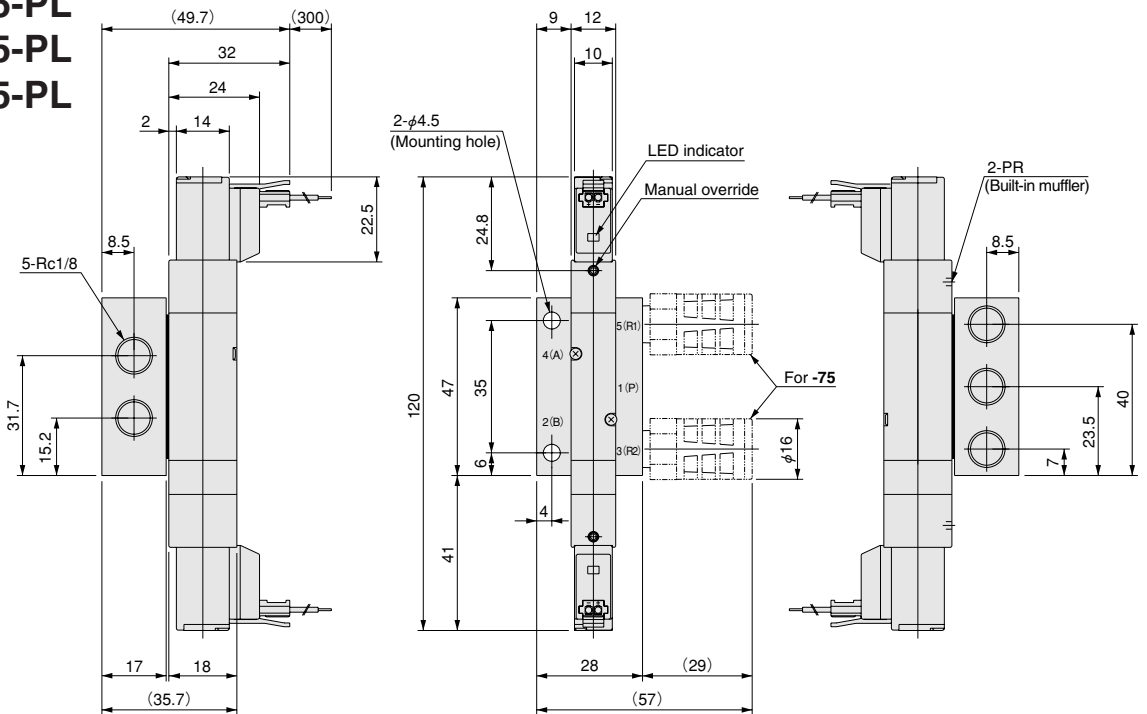

Options

● Mounting base: **-22**
(for side mounting)

● Locking type manual override: **-81**

● Lever type manual override: **-84**

● Grommet: **-GL**

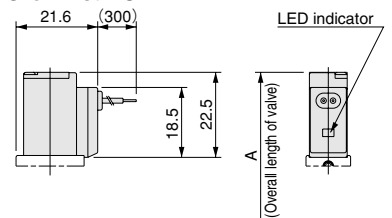
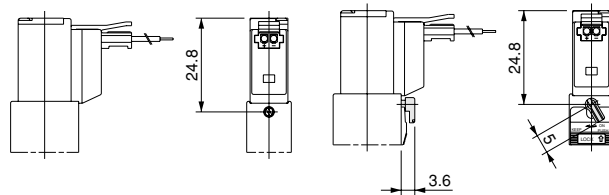
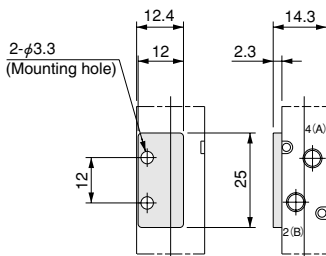

● S type plug connector: **-PS**

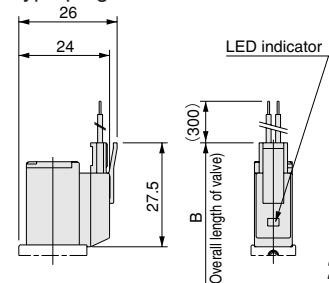

Model	Code	A	B	Remark
JE12F6, JE12A6		111	121	Overall length to the opposite end of the solenoid
JE12F7~JE12F9, JE12A7~JE12A9		120	130	
JE12LF6, JE12LA6, JE12SF6, JE12SA6		—	121	
JE12LF7~JE12LF9, JE12LA7~JE12LA9		—	130	
JE12SF7~JE12SF9, JE12SA7~JE12SA9		—	130	

Dimensions of JE Series Manifold (mm)

Manifold for combination mounting of 2, 3, 5-port valves

JEM□F

(Direct piping type)

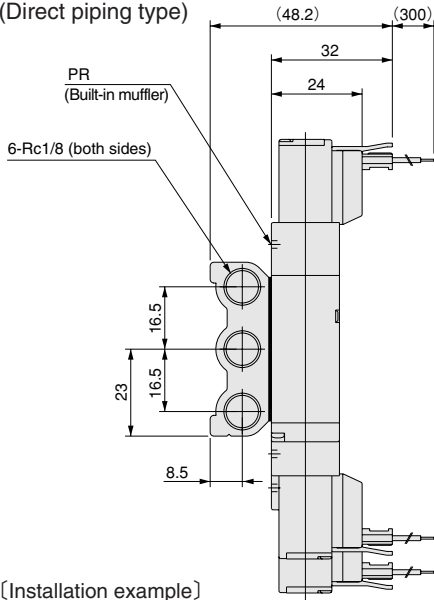

[Installation example]

JEM6F

- stn.1 JE12F3-PL-D4
- stn.2 JE12F4-PL-D4
- stn.3 JE12F5-PL-D4
- stn.4 JE12F6-PL-D4
- stn.5 JE12F7-PL-D4
- stn.6 JEBP

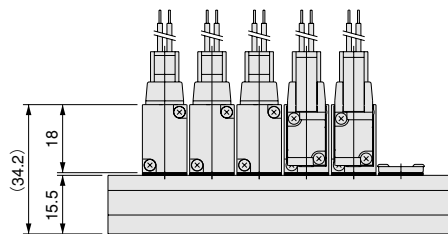
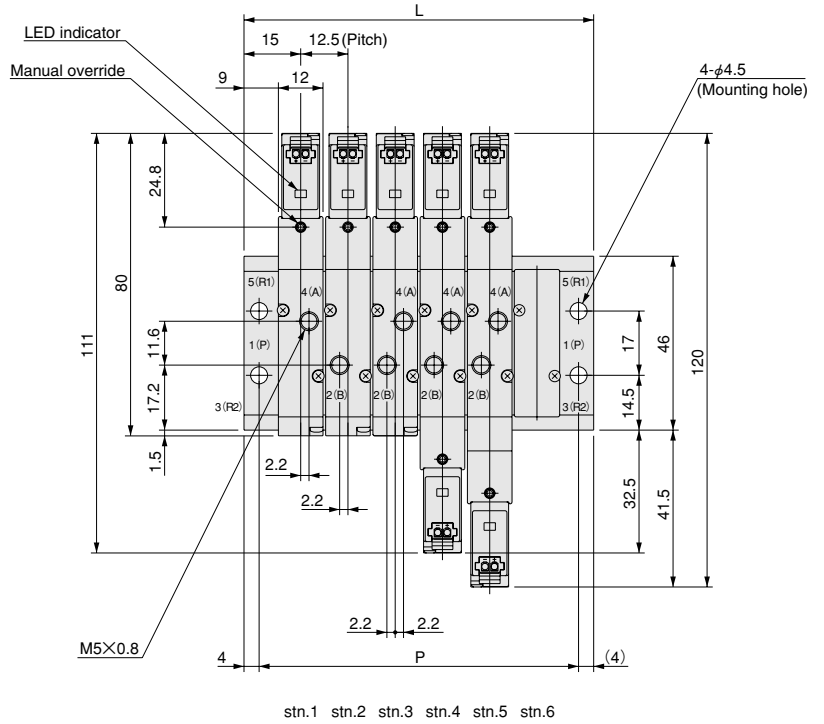

Unit dimensions

Number of units	L	P
2	42.5	34.5
3	55.0	47.0
4	67.5	59.5
5	80.0	72.0
6	92.5	84.5
7	105.0	97.0
8	117.5	109.5
9	130.0	122.0
10	142.5	134.5
11	155.0	147.0
12	167.5	159.5
13	180.0	172.0
14	192.5	184.5
15	205.0	197.0
16	217.5	209.5
17	230.0	222.0
18	242.5	234.5
19	255.0	247.0
20	267.5	259.5

Dimensions of JE Series Manifold (mm)

Manifold for combination mounting of 2, 3, 5-port valves

JEM□A

(Base piping type)

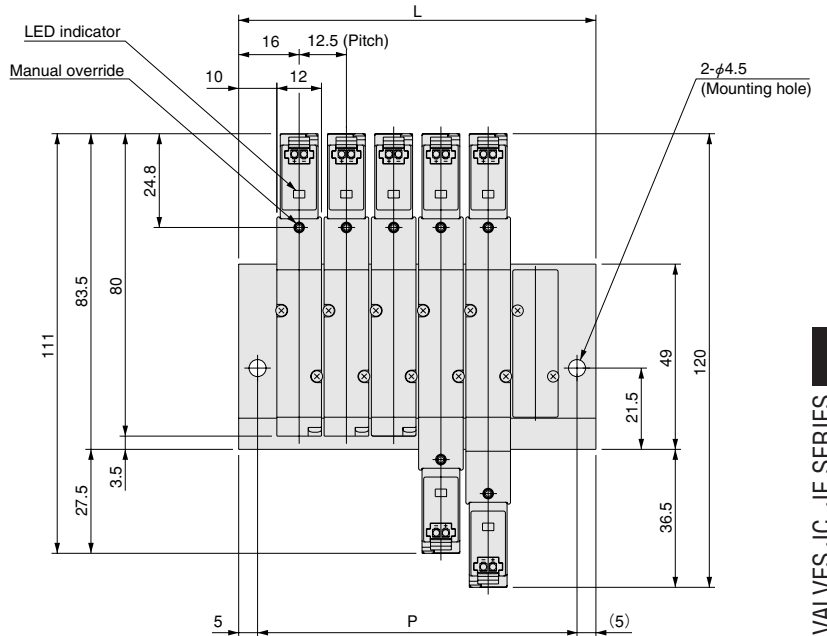
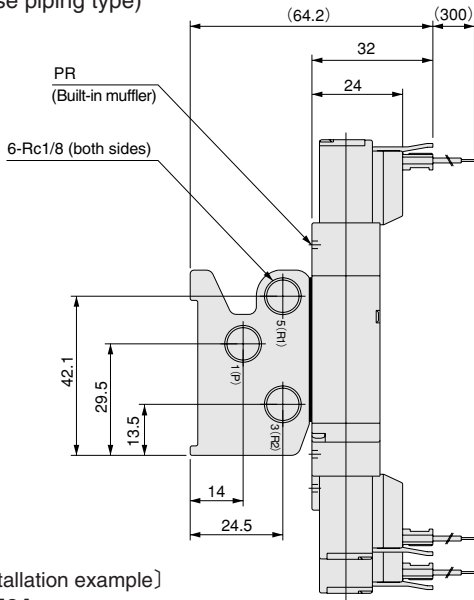

[Installation example]

JEM6A

- stn.1 JE12A3-PL-D4
- stn.2 JE12A4-PL-D4
- stn.3 JE12A5-PL-D4
- stn.4 JE12A6-PL-D4
- stn.5 JE12A7-PL-D4
- stn.6 JEBP

stn.1 stn.2 stn.3 stn.4 stn.5 stn.6

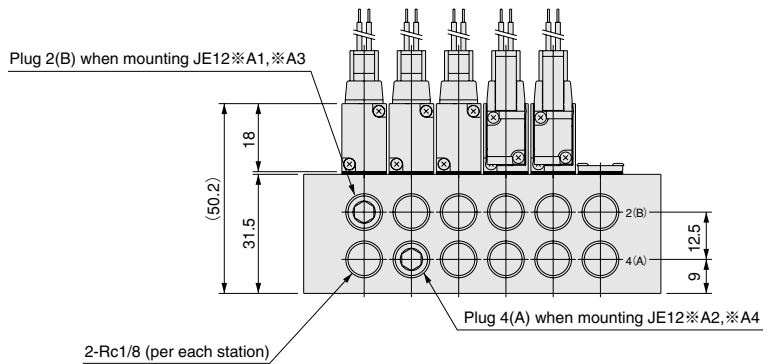

● DIN rail mounting bracket (-DN)

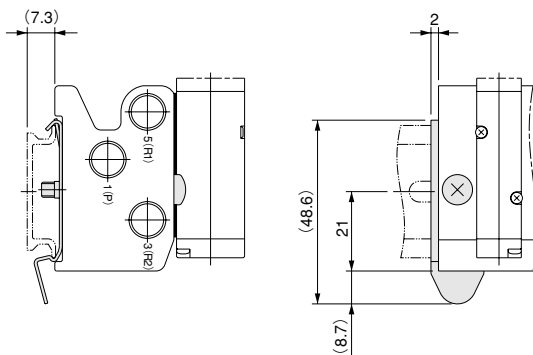

Unit dimensions

Number of units	L	P
2	44.5	34.5
3	57.0	47.0
4	69.5	59.5
5	82.0	72.0
6	94.5	84.5
7	107.0	97.0
8	119.5	109.5
9	132.0	122.0
10	144.5	134.5
11	157.0	147.0
12	169.5	159.5
13	182.0	172.0
14	194.5	184.5
15	207.0	197.0
16	219.5	209.5
17	232.0	222.0
18	244.5	234.5
19	257.0	247.0
20	269.5	259.5