

# MEMBRANE AIR DRYERS Using Hollow Fiber Membranes to Dehumidify Compressed Air.

## ● No freon, no power supply

Freon-free air dryer uses hollow fiber membranes for a gentle touch on the global environment.

A power supply is unnecessary.

## ● No vibrations, no heat emissions, long service life

No mechanical moving parts means no vibration and no heat emissions, for longer operating life.

## ● With dew point indicator

Dew point indicator allows condensation check.

## ● No drain media

The extracted moisture is emitted as water vapor, preventing drain media problems.

## ● Compact, lightweight

Compact, lightweight body occupies 1/5th the installation space and less than 1/10th the mass (compared to Koganei refrigerating type air dryer).

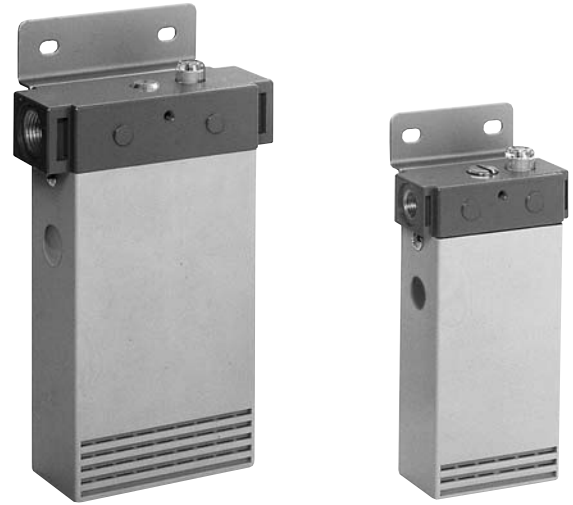

### Application example

- Dehumidification of air source for precision equipment
  - Air bearings
  - Laser processing machine
  - Electrical discharge machine
  - Slicers, etc.
- Supply of dry air for precision measurement instruments
- Supply of dry air for semiconductor devices
- Supply of dry air for packaging equipment and printers
- Air control at airline ends

## Dehumidification Principles

Compressed air (moist air) is supplied on the inside of the hollow fiber membrane, while purged air (dry air) is supplied on the outside, creating a water vapor pressure differential between the inside and outside that allows water vapor contained in the compressed air to penetrate into the membrane, where it is exhausted to the outside alongside the purged air, in a continuous dehumidification process.

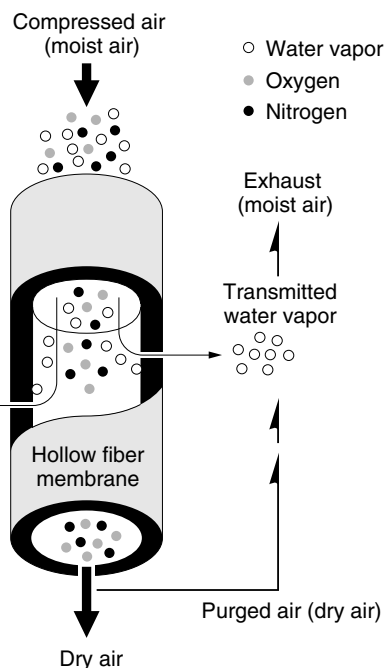

## Order Codes

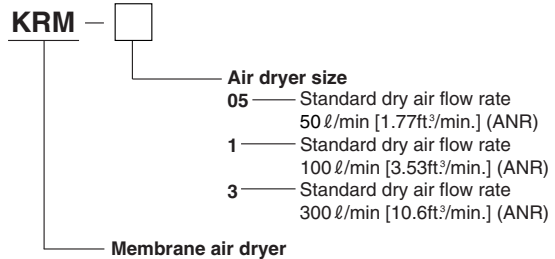

### Additional part

Dew point indicator use paper — **IN-KRM**

**Caution:** Always install a micro mist filter upstream of the membrane air dryer for use. For the order code, see p.213, "Membrane Air Dryer System Diagrams."

# Specifications

Item	Model	KRM-05	KRM-1	KRM-3
Operating conditions	Media <sup>Note 1</sup>	Air		
	Operating pressure range MPa [psi.]	0.2~0.83 [29~120]		
	Supply air temperature °C [°F]	5~55 [41~131]		5~40 [41~104]
	Ambient temperature °C [°F]	5~55 [41~131]		5~40 [41~104]
Normal ratings	Ambient temperature °C [°F]	30 [86]		
	Supply air temperature °C [°F]	28 [82.4]		
	Vapor content in supply air	Saturation at 28°C [82.4°F]		
	Supply air pressure MPa [psi.]	0.69 [100]		
	Supply air flow rate ℓ/min [ft. <sup>3</sup> /min.] (ANR)	33~133 [1.17~4.70]	65~205 [2.30~7.24] (53~193 [1.87~6.81]) <sup>Note 3</sup>	195~615 [6.89~21.71] (158~578 [5.58~20.41]) <sup>Note 3</sup>
	Purged air flow rate <sup>Note 2</sup> ℓ/min [ft. <sup>3</sup> /min.] (ANR)	13 [0.46]	25 [0.88] (13 [0.46]) <sup>Note 3</sup>	75 [2.65] (38 [1.34]) <sup>Note 3</sup>
	Dry air flow rate ℓ/min [ft. <sup>3</sup> /min.] (ANR)	20~120 [0.71~4.24]	40~180 [1.41~6.36]	120~540 [4.24~19.07]
Dry air dew point °C [°F]	-26~-10 [-14.8~14]	-26~-12 [-14.8~10.4] (-23~-10 [-9.4~14]) <sup>Note 3</sup>	-26~-12 [-14.8~10.4] (-23~-10 [-9.4~14]) <sup>Note 3</sup>	
Mass kg [lb.]	0.4 [0.88]	0.4 [0.88]	0.9 [2.0]	

- Notes: 1. For the use of other than compressed air as media, consult us. In addition, remove moisture and oil from the compressed air.  
 2. Purged air can be exhausted from piping.  
 3. Figures in parentheses ( ) show the small value for purged air flow rate (when the supplied orifice is attached).

## Relationship Between Operating Conditions and Dry Air Dew Point

The air dryness increases with higher air pressure, lower temperature, and less flow rate. Larger purged air flow rate also boosts air dryness.

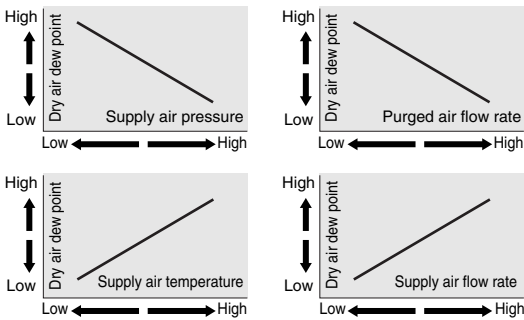

## Supply Air Pressure and Purged Air Flow Rate

When the purged air flow rate is large, the purged air flow rate can be cut almost in half by switching to the orifice provided. In this case, the dew point will rise slightly.

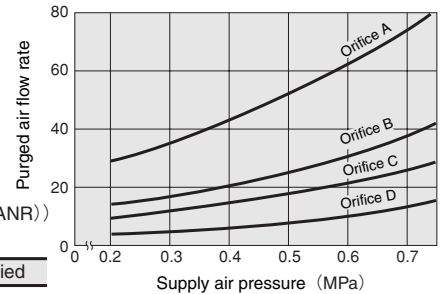

### Types of orifice

	Standard	Supplied
KRM-05	Orifice D	—
KRM-1	Orifice C	Orifice D
KRM-3	Orifice A	Orifice B

1MPa = 145psi. 1 ℓ/min = 0.0353ft.<sup>3</sup>/min.

## Dimensions (mm)

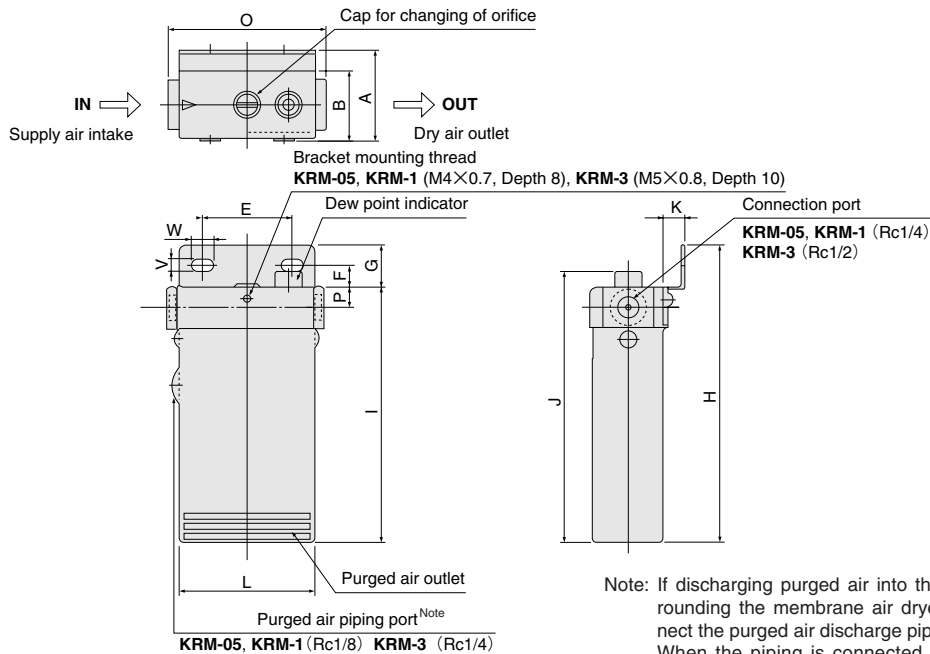

Note: If discharging purged air into the area immediately surrounding the membrane air dryer is unacceptable, connect the purged air discharge piping. When the piping is connected, the discharge from the purged air outlet will cease.

Code	A	B	E	F	G	H	I	J	K	L	O	P	V	W
KRM-05	53.5	40	46	13	25	175	150	161	12	70	82	12	6	10
KRM-1														
KRM-3	69	50	66	15	30	220	190	200	17	100	124	16	6	10

# Dry Air Flow Rate, Dry Air Dew Point, and Pressure Loss

## ● Supply air: At 0.3MPa [44psi.] (saturation at 28°C [82.4°F])

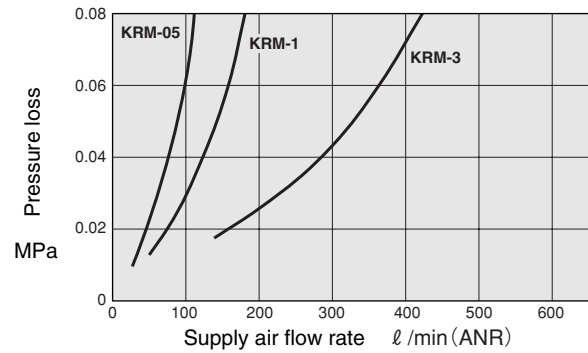
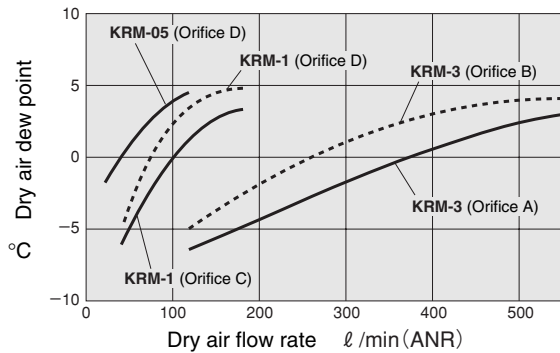

## ● Supply air: At 0.5MPa [73psi.] (saturation at 28°C [82.4°F])

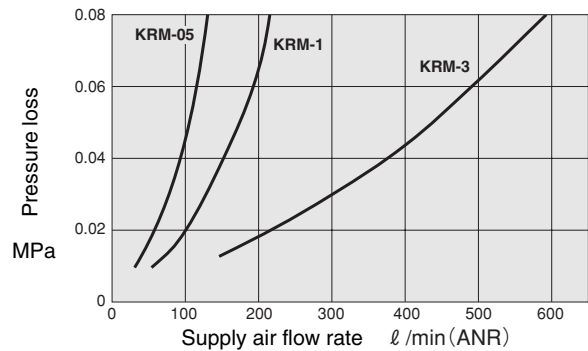
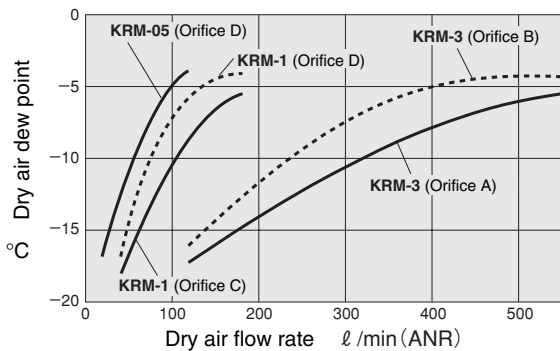

## ● Supply air: At 0.7MPa [102psi.] (saturation at 28°C [82.4°F])

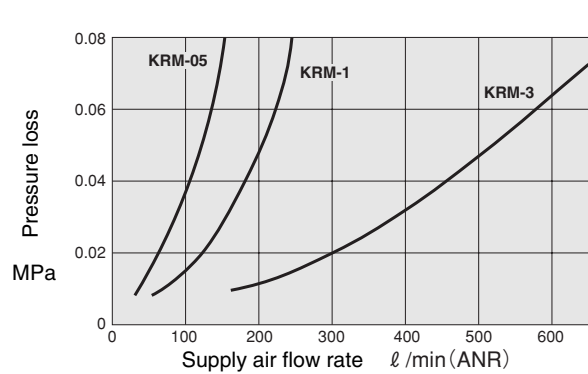
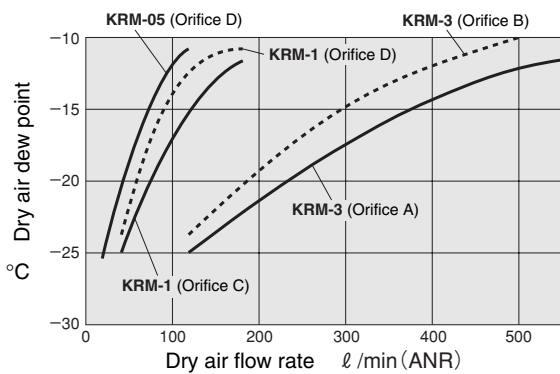

Remark: The dry air dew point can change, depending on the purged air volume.  
Replacement of the orifice inside the membrane air dryer body will change the purged air volume (KRM-1, KRM-3 only).

$$F = 9C/5 + 32, 1 \text{ l/min} = 0.0353 \text{ ft}^3/\text{min}, 1 \text{ MPa} = 145 \text{ psi.}$$

## Dew Point and Relative Humidity Conversion Table

Dew point °C [°F]	30 [86]	25 [77]	20 [68]	15 [59]	10 [50]	5 [41]	0 [32]	-5 [23]	-10 [14]	-15 [5]	-20 [-4]	-25 [-13]	-30 [-22]	-35 [-31]	-40 [-40]
Relative humidity %															
Air temperature 10°C [50°F]	—	—	—	—	100	71	50	33	21	13	8.4	5.1	3.1	1.8	1.0
Air temperature 20°C [68°F]	—	—	100	73	52	37	26	17	11	7.1	4.4	2.7	1.6	1.0	0.55
Air temperature 30°C [86°F]	100	75	55	40	29	21	14	9.5	6.1	3.9	2.4	1.5	0.89	0.52	0.30

## Model Selection on Dry Air Flow Rate

### How to select the most suitable model

#### Selection formula

$$\text{Standard dry air flow rate} > \frac{\text{Dry air flow rate}}{\text{Pressure correction coefficient} \times \text{Temperature correction coefficient} \times \text{Dew point correction coefficient}}$$

※ If the dry air flow rate is 20 ℓ /min [0.706ft<sup>3</sup>/min.] (ANR) or less, certain conditions may prevent some models from being selected. Consult us.

#### Selection example 1

**Conditions**

- Dry air flow rate: 100 ℓ /min (ANR)
- Supply air pressure: 0.5MPa
- Supply air temperature: 35°C
- Dry air dew point: -10°C



From the conditions at left:

- Dry air flow rate **100 ℓ /min (ANR)**
- Supply air pressure: At 0.5MPa, Coefficient Table 1. gives a correction coefficient of **0.45**.
- Supply air temperature: At 35°C, Coefficient Table 2. gives a correction coefficient of **0.6**.
- Dry air dew point : At -10°C, Coefficient Table 3. gives a correction coefficient of **2.2**.

$$\frac{100}{0.45 \times 0.6 \times 2.2} \doteq 168$$

Using the Standard Dry Air Flow Volume and Orifice Table, 168 ℓ /min (ANR) is satisfied by **KRM-3 (Orifice B)**, due to its standard dry air flow rate of 240 ℓ /min (ANR).

F = 9C/5 + 32, 1 ℓ/min = 0.0353ft<sup>3</sup>/min., 1MPa = 145psi.

#### Selection example 2

**Conditions**

- Dry air flow rate: 50 ℓ /min (ANR)
- Supply air pressure: 0.7MPa
- Supply air temperature: 35°C
- Dry air dew point: -10°C



From the conditions at left:

- Dry air flow rate **50 ℓ /min (ANR)**
- Supply air pressure: At 0.7MPa, Coefficient Table 1. gives a correction coefficient of **1.0**.
- Supply air temperature: At 35°C, Coefficient Table 2. gives a correction coefficient of **0.6**.
- Dry air dew point: At -10°C, Coefficient Table 3. gives a correction coefficient of **2.2**.

$$\frac{50}{1.0 \times 0.6 \times 2.2} \doteq 38$$

Using the Standard Dry Air Flow Volume and Orifice Table, 38 ℓ /min (ANR) is satisfied by **KRM-05 (Orifice D)**, due to its standard dry air flow rate of 50 ℓ /min (ANR).

F = 9C/5 + 32, 1 ℓ/min = 0.0353ft<sup>3</sup>/min., 1MPa = 145psi.

#### Standard Dry Air Flow Rate and Orifice Table

Model	KRM-05	KRM-1		KRM-3	
Standard dry air flow rate ℓ /min [ft <sup>3</sup> /min] (ANR)	50 [1.77]	80 [2.82]	100 [3.53]	240 [8.47]	300 [10.59]
Orifice	Orifice D	Orifice D	Orifice C	Orifice B	Orifice A

#### Coefficient Tables

##### 1. Supply air pressure correction coefficient table

Supply air pressure MPa [psi.]	0.2 [29]	0.29 [42]	0.39 [57]	0.49 [71]	0.59 [86]	0.69 [100]	0.78 [113]
Correction coefficient	0.05	0.14	0.27	0.45	0.70	1.0	1.4

##### 2. Supply air temperature correction coefficient table







Supply air temperature °C [°F]	0 [32]	5 [41]	10 [50]	15 [59]	20 [68]	25 [77]	28 [82.4]	30 [86]	35 [95]	40 [104]	45 [113]	50 [122]	55 [131]
Correction coefficient	7.6	5.3	3.7	2.6	1.8	1.2	1.0	0.9	0.6	0.42	0.30	0.21	0.14

##### 3. Dry air dew point correction coefficient table

Dry air dew point °C [°F]	-30 [-22]	-25 [-13]	-20 [-4]	-17 [1.4]	-15 [5]	-10 [14]	-5 [23]	0 [32]	5 [41]	10 [50]
Correction coefficient	0.22	0.4	0.7	1.0	1.3	2.2	4.0	7.1	12.5	22

## Membrane Air Dryer System Diagrams (Reference)

Caution: Always mount an air filter (5  $\mu\text{m}$ ) and micro mist filter (0.01  $\mu\text{m}$ ) upstream of the membrane air dryer for use.

	Air filter (5 $\mu\text{m}$ )	Connection module	Micro mist filter (0.01 $\mu\text{m}$ )	Connection module	Membrane air dryer	Connection module	Regulator
			 With auto drain <sup>Note</sup>				
<b>KRM-05</b>	F150-02	8-20D	MMF150-02-A <sup>Note</sup>	8-30F	KRM-05	8-20D	R150-02
<b>KRM-1</b>					KRM-1		
<b>KRM-3</b>	F300-03-A <sup>Note</sup>	8-40D	MMF300-04-A <sup>Note</sup>	8-60F	KRM-3	8-40D	R300-03

 denotes the absolute minimum system.

Note: Some models without an auto drain are available. To order such models, remove **-A** from the order code.

## Handling Instructions and Precautions



### Mounting and piping

1. Install in locations where the supply air and ambient temperature is 40°C [104°F] or less (for **KRM-05**, 55°C [131°F] or less).
2. If connecting piping to the air compressor outlet port, use air that has passed through an aftercooler to cool the temperature at 40°C [104°F] or below, then install a filter and micro mist filter to prevent intrusion of oil mist to the membrane air dryer.
3. The membrane air dryer cannot operate on its own to remove water vapor or collected liquid.  
If water vapor or collected liquid is intruding, use a filter and micro mist filter.
4. For the mounting method, install vertically with the piping connection part on the top.  
In addition, leave a space to facilitate maintenance.  
(minimum of 100mm [3.94in.] from the floor)
5. The membrane air dryer discharges constant purged air from the purged air outlet.  
If discharging purged air into the area immediately surrounding the membrane air dryer is unacceptable, remove the cover of the purged air piping port and plumb piping for the purged air discharge. When the piping is plumbed, the discharge from the purged air outlet will cease.  
If using piping connection fittings **8-30F** or **8-60F** to connect the micromist filter and membrane air dryer, screw in the quick fitting first before making the connection. The quick fitting cannot be screwed in after the connection is completed because of interference with the micro mist filter.

Recommended fittings

**KRM-05: SLH6-01**

**KRM-1: SLH6-01**

**KRM-3: SLH10-02**

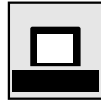

### Indicator

Check the color of the indicator during the daily inspections.  
Blue means that the situation is normal.  
If the outlet dew point is rising, the color will change to pink or white.  
In such a situation, see the instruction manual provided with the product, under "Causes of Breakdowns and Abnormalities, and Countermeasures."



### General precautions

1. Always thoroughly blow off (use compressed air) the piping before plumbing.  
Entering chips, sealing tape, rust, etc., generated during plumbing could result in air leaks or other defective operation.
2. The product cannot be used when the media or the ambient atmosphere contains any of the substances listed below.  
Organic solvents, phosphate ester type hydraulic oil, sulphur dioxide, chlorine gas, chlorofluorocarbon or acids, etc.
3. If using in locations subject to dripping water, dripping oil, etc., or to large amounts of dust, use something to cover and protect the unit.