

# SHOCK ABSORBER Series

## Fixed Absorption Capacity Linear Orifice Type

### KSHJ Series

Page 571

Total of 12 sizes and 66 models from M4 to M27 size.

Offers wide range of speeds, with maximum impact speed of 0.8 m/s to 3 m/s<sup>Note</sup>.

Note: The maximum impact speed varies by model.  
See specification table on p.571.



● With cap



● With stopper nut



● With side mounting bracket



## What is the linear orifice type?

Use of a linear orifice mechanism, in which the orifice changes linearly, ensures smooth shock absorption.

Achieves the performance of shock absorbers with next-size-up stroke lengths, to reduce vibrations on mounting frames and equipment.

Reduces the shock value in impacts, to lower the noise during workpiece impacts.

### Operation principle

The piston stroke linearly squeezes the oil path, for soft absorption of shocks.

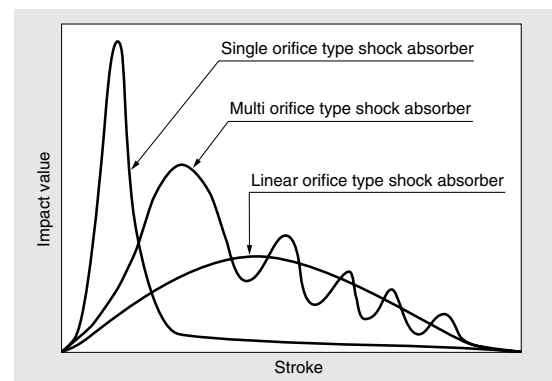
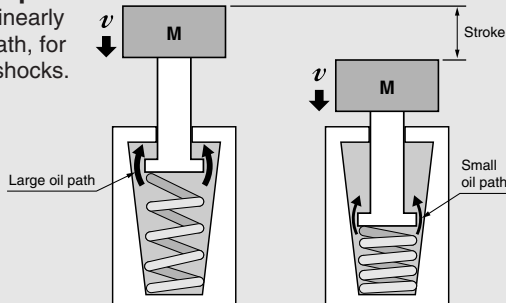

## Fixed Absorption Capacity Linear Orifice Type

### KSHA Series

Page 579

Total of five sizes, from M6 to M14.

All sizes can be set with heavy load and light load absorption capacities.



● Insert mounting type



● With cap



● With stopper nut



● With flange mounting bracket



● With side mounting bracket



### KSHC Series (Clean Room Specification) Class 5 (Equivalent to FED-STD209E Class 100) compatibility

Page 585

Total of eight sizes, from M6 to M25.

Uses a special particle pocket structure, to prevent flying dust out.

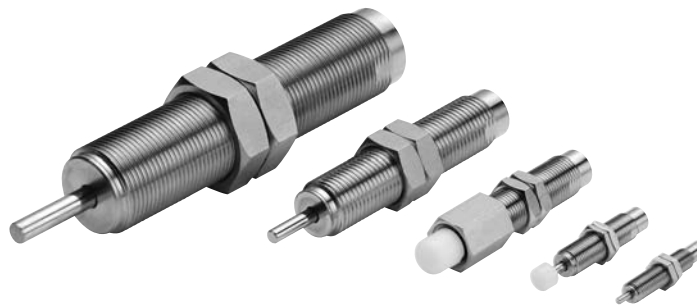

● With cap



● With stopper nut



## Adjustable Absorption Capacity Type

<b>KSHE Series</b>	<b>KSHES Series</b>
<p data-bbox="124 185 879 241">           Multi orifice type            Self-compensating type shock absorber. Optimum for high-speed impacts.         </p> <div data-bbox="236 300 863 448"> <p data-bbox="148 450 863 472">             Side mounting bracket : -2    Flange mounting bracket : -3    Stopper nut : -S           </p> </div> <div data-bbox="236 566 802 949"> <p data-bbox="240 837 384 860">KSHE 10×20C</p> <p data-bbox="523 927 639 949">KSHE12×22</p> </div>	<p data-bbox="959 185 1481 271">           Multi orifice type with sensor switches            Can perform position detection simultaneously with completion of shock absorption.         </p> <div data-bbox="1034 255 1433 613"> <p data-bbox="1007 647 1203 669">KSHES12×22-H-□□</p> </div> <div data-bbox="1066 600 1433 981"> <p data-bbox="1107 958 1315 981">KSHES12×22-HS-□□</p> </div>
<b>KSH Series</b>	<b>Page 592</b>
<p data-bbox="124 1088 456 1144">           Single orifice type            Optimum for low-speed impacts.         </p> <div data-bbox="539 1126 1161 1361"> <p data-bbox="555 1346 660 1368">KSH8×10C</p> <p data-bbox="986 1346 1091 1368">KSH12×22</p> </div>	

## Safety Precautions (Shock Absorbers)

The following is a safety precaution to Shock Absorbers. For other safety precautions, be sure to read the precautions on p.49.

### Danger

- Do not touch or approach too close to the product while it is in operation. Also, do not attempt to mount a shock absorber or adjust operations while devices are operating. Unintended movement of devices could result in personal injury.

### Warning

- Never loosen or remove the small screw on the rear end surface of the shock absorber. The oil inside will leak out and damage shock absorber function, which could result in injury.
- For product mounting, always observe the handling instructions and precautions. In addition, when a product has been mounted, before starting operation always check whether mounting nuts have been attached and are secured, etc. Looseness in the mounting nuts could lead to equipment damage, or to accidents.

### Caution

- Do not coat the sliding sections with any lubricant whatsoever. Such lubrication could alter or degrade the properties of the product materials, or reduce performance.
- Attempting to use the shock absorber with cap over the specification range could result in damage to the cap or to its flying off and causing personal injury. Moreover, if cracks or fractures appear in the cap, replace it as quickly as possible.

### Attention

- When the product's service life is completed or when it is no longer needed, dispose of it as an industrial waste product, in accordance with the Waste Disposal and Public Cleaning Law, or with other local laws and ordinances. Note that because the special oil used in the KSHC series (clean room specification) gives off hydrofluoric acid, a corrosive, toxic substance, when incinerated, disposal should be performed at an incinerator equipped with acid-resisting toxic removal facilities. If large volumes need disposal, consign the operation to a registered waste disposal company.
- The maximum absorption performance in the specifications are values at normal temperatures (20~25°C [68~77°F]). Be aware that performance and characteristics may change depending on the operating temperature.
- The shock absorber's absorption capacity can change depending on the impact speed. Use it within the range shown in the selection graphs (impact mass and impact speed graphs) on p.572, 580, 586 and 593.

## Handling Instructions and Precautions



### General precautions

If mounting in locations subject to dripping water, dripping oil, etc., or to large amounts of dust, use something to cover and protect the unit. Accumulations of water, oil, or dust can reduce the shock absorber's service life.



### Adjustment of shock absorption capacity

#### ● Adjustable absorption capacity type : KSHE and KSH series

1. Align the white mark on the shock absorption adjusting knob to 2 or 3 on the scale.
2. For cases where the stroke end is still undergoing shocks, turn the adjusting knob toward 6 on the scale. In cases where the rod stops before the preset stroke end, or when the shock at time of impact is very large, turn the adjusting knob toward "0" on the scale.
3. When adjustment is complete, always be sure to tighten the lock screw to secure the adjusting knob in place.
4. The KSHE series are designed so that the final orifice hole is closed at the stroke end. Shortening the stroke could lead to an inability to adequately absorb the impact energy. It is recommended that use of the full stroke be made. Moreover, the shock absorber for the KSHE series operate differently when its rod is manually pushed in as opposed to actual operation.

#### ● Fixed absorption capacity type : KSHJ, KSHA, KSHC series

For the fixed absorption capacity type, shock absorption capacity cannot be adjusted. See the Selection Guideline on p.572, 580, 586 to select a model with the optimum shock absorption capacity.



### Mounting

1. Mount the shock absorber so that the load contacts at the center of the rod, and it is not subjected to off-centered loads. An off-centered load could result in breakage or defective rod returns. If there is concern that off-centered loads will occur, install a guide, etc.
2. Two or more shock absorbers can be mounted in parallel, to boost absorption capacity. In such an arrangement, however, be careful to ensure that the load is evenly distributed to each shock absorber.
3. The surface in direct contact with the shock absorber rod should have a hardness of HRc40 or more (excluding with cap models).
4. When mounting the shock absorber, do not exceed the maximum tightening torque for the hexagon nut, shown in the table below. Excessive tightening could damage the unit.

Model	N · m [ft · lbf]	
	Maximum tightening torque	
KSHJ4×3 (C) -01,-02	0.5 [0.37]	
KSHJ6×4 (C) -01,-02	0.85 [0.63]	
KSHJ8×5 (C) -01,-11	2.5 [1.8]	
KSHJ8×8 (C) -01,-02,-11,-12	2.5 [1.8]	
KSHJ10×10 (C) -01,-02	6.5 [4.8]	
KSHJ10×15 (C) -01,-03	6.5 [4.8]	
KSHJ12×10 (C) -01,-02	6.5 [4.8]	
KSHJ14×12 (C) -01,-02	12.0 [8.9]	
KSHJ16×15 (C) -01,-02	20.0 [14.8]	
KSHJ18×16 (C) -01,-02	25.0 [18.4]	
KSHJ20×16 (C) -01,-02	30.0 [22.1]	
KSHJ22×25 (C) -01,-02	35.0 [25.8]	
KSHJ25×25 (C) -01,-11,-12	42.0 [31.0]	
KSHJ27×25 (C) -01,-02,-11,-12	42.0 [31.0]	

# Handling Instructions and Precautions

N·m [ft·lbf]	
Model	Maximum tightening torque
KSHA4×4, CS-KSHC4×4	0.85 [0.63]
KSHA5×5, CS-KSHC5×5	2.5 [1.84]
KSHA6×5	6.5 [4.79]
KSHA6×8, CS-KSHC6×8	
KSHA7×8, CS-KSHC8×8	12.0 [8.85]
KSHA8×10, CS-KSHC9×10	
CS-KSHC11×15C	20.0 [14.8]
CS-KSHC14×16C	30.0 [22.1]
CS-KSHC18×25C	42.0 [31.0]

N·m [ft·lbf]	
Model	Maximum tightening torque
KSHE5×8, KSH5×8	8.0 [5.90]
KSHE6×10, KSH6×10	
KSHE(S)8×15, KSH8×10	15.0 [11.1]
KSHE(S)10×20, KSH10×15	24.0 [17.7]
KSHE(S)12×22, KSH12×22	30.0 [22.1]

**●Fixed absorption capacity type**  
**KSHJ, KSHA, KSHC series**

1. If using “with cap” or changing the stroke to adjust absorption capacity, use a stopper.
2. If using “with cap”, always mount a stopper nut (-S) or an external stopper to ensure that the cap is not subjected to loads at the stroke end. For the stopper nut mounting position, see the dimensions in the table below. While the shock absorber can be used without a stopper nut (-S) or external stopper, in such an arrangement, the stop position may change due to deformation of the cap after a long period of use.

mm [in.]	
Model	A
KSHJ4×3C-01,-02	3 [0.118]
KSHJ6×4C-01,-02	4 [0.157]
KSHJ8×5C-01,-11	5 [0.197]
KSHJ8×8C-01,-02,-11,-12	8 [0.315]
KSHJ10×10C-01,-02	10 [0.394]
KSHJ10×15C-01,-03	15 [0.591]
KSHJ12×10C-01,-02	10 [0.394]
KSHJ14×12C-01,-02	12 [0.472]
KSHJ16×15C-01,-02	15 [0.591]
KSHJ18×16C-01,-02	16 [0.630]
KSHJ20×16C-01,-02	16 [0.630]
KSHJ22×25C-01,-02	25 [0.984]
KSHJ25×25C-01,-11,-12	25 [0.984]
KSHJ27×25C-01,-02,-11,-12	25 [0.984]

mm [in.]	
Model	A
KSHA4×4C, CS-KSHC4×4C	3.5~3.9 [0.138~0.154]
KSHA5×5C, CS-KSHC5×5C	4.5~4.9 [0.177~0.193]
KSHA6×5C	
KSHA6×8C, CS-KSHC6×8C	7.5~7.9 [0.295~0.311]
KSHA7×8C, CS-KSHC8×8C	
KSHA8×10C, CS-KSHC9×10C	9.5~9.9 [0.374~0.390]
CS-KSHC11×15C	14.5~14.9 [0.571~0.587]
CS-KSHC14×16C	15.5~15.9 [0.610~0.626]
CS-KSHC18×25C	24.5~24.9 [0.965~0.980]

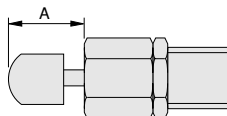

3. For swing impacts, ensure that the angle of eccentricity between the load direction and the center line of the shock absorber is at or below the specification values shown on p.571, p.579 and p.585.
4. Do not loosen or remove the small screw on the rear end of the shock absorber. The oil contained inside could leak out, damaging shock absorber functions.

**●Insert mounting : KSHA□×□□-X**

1. For the dimensions of the mounting hole for the insert mount, see the insert mounting hole drawings on p.583.
2. When using a panel mounting, use the values in the table below to determine the maximum thickness of the panel.

mm [in.]	
Model	Maximum panel thickness
KSHA6×8□-X	8 [0.315]
KSHA7×8□-X	10 [0.394]

**●Adjustable absorption capacity type**  
**KSHE and KSH series**

1. Do not use the end surface of the shock absorber body in the rod side as a stopper. Always use a stopper nut (Order code: -S) or external stopper.
2. When using the stopper nut, adjust the stopper nut location so that it protrudes 0.5 mm [0.02 in.] from the end surface of the KSHE series shock absorber body, and 0.5 to 1.0 mm [0.02 to 0.04 in.] from the KSH series.
3. When using an external stopper, mount so that impacting objects are stopped 0.5 mm [0.02 in.] in front of the end surface of the KSHE series shock absorber body, and 0.5 to 1.0 mm [0.02 to 0.04 in.] in front of the KSH series.
4. For swing impacts, ensure that the angle of eccentricity between the load direction and the center line of the shock absorber is 3° or less.

**KSHEs series**

1. For holders that can directly stop loads, use a stopper type holder (-HS). If using holders that do not have a stopper function (-H), use an external stopper.
2. Holders and external stoppers should receive all the remaining energy for loads when stopping. Do not let the cap become subjected to loads at the stroke end.

## ● Calculation

For the calculations, use the speed immediately before striking the absorber. For air cylinders, the speed immediately before striking is larger than the average speed obtained from the "time required for cylinder stroke". In this case, shorter strokes increase the speed, and it reaches 1.2 to 2.0 times higher than the average speed.

Selection procedure of shock absorber

Impact mass  $m$  kg  
 [Impact weight  $w'$  lbf.]  
 Impact speed  $v$  m/s [ft./sec.]

When additional energy is not applied.

When additional energy from the cylinder, rotary actuator, etc., is applied

Item	Horizontal impact		Horizontal impact		Vertical impact		Swing impact			
	Simple horizontal impact		Cylinder impact	Free fall	Cylinder impact	Arm swing	Turn table			
Impact example										
Impact mass $m$ kg [Impact weight $w'$ lbf.]	$m$	$w'$	$m$	$w'$	$m$	$w'$	$m$	$w'$	$m$	$w'$
Impact speed $v$ m/s [ft./sec.]	$v$		$v$	$v$	$v$	$v$	$v=R \cdot \omega$		$v=R \cdot \omega$	
Kinetic energy $E_1$ J [ft·lbf]	$\frac{m \cdot v^2}{2}$	$\frac{w' \cdot v^2}{2 \cdot g}$	$\frac{m \cdot v^2}{2}$	$\frac{w' \cdot v^2}{2 \cdot g}$	$m \cdot g \cdot h$	$\left\{ \begin{matrix} w' \cdot h \\ w' \cdot h \end{matrix} \right\}$	$\frac{m \cdot v^2}{2}$	$\frac{w' \cdot v^2}{2 \cdot g}$	$\frac{I \cdot \omega^2}{2}$	$\frac{I' \cdot \omega^2}{2}$
Thrust, mass, and other additional energy $E_2$ J [ft·lbf]	—		$F \cdot L$	$\left\{ \begin{matrix} F \cdot L \\ F \cdot L \end{matrix} \right\}$	$m \cdot g \cdot L$	$\left\{ \begin{matrix} w' \cdot L \\ w' \cdot L \end{matrix} \right\}$	$(m \cdot g + F) \cdot L$	$\left\{ \begin{matrix} (w' + F) \cdot L \\ (w' + F) \cdot L \end{matrix} \right\}$	$\frac{T \cdot L}{R}$	$\frac{T' \cdot L}{R}$
Total energy $E$ J [ft·lbf]	$E_1$		$E_1 + E_2$		$E_1 + E_2$		$E_1 + E_2$		$E_1 + E_2$	

Shaded areas show calculations using the imperial units.  
 [ ] shows imperial units.

Maximum operating frequency cycle/min  
 Operating ambient temperature °C [°F]

Select models where the  $m, v, E, L$ , operating frequency and temperature satisfy the specifications.

Remark: The shock absorber's absorption energy will vary depending on speed, temperature, and other conditions. This calculation equation is provided for a general indication only. We recommend selecting from the selection graphs on p.572~573, 580, 586, and 593.

Code explanations	(Unit)
$m$ : Impact mass	kg
$w'$ : Impact weight	[lbf.]
$v$ : Impact speed	m/s [ft./sec.]
$E$ : Total energy	J [ft·lbf]
$E_1$ : Kinetic energy	J [ft·lbf]
$E_2$ : Additional energy	J [ft·lbf]
$g$ : Acceleration of gravity	9.8m/s <sup>2</sup> [32.2ft./sec. <sup>2</sup> ]
$F$ : Cylinder thrust	N
$F = \pi / 4 \times D^2 \times P$	
$D$ : Bore size	mm
$P$ : Operating air pressure	MPa
$F$ : Cylinder thrust	N
$F'$ : Cylinder thrust	[lbf.]
$F' = \pi / 4 \times D'^2 \times P'$	
$D'$ : Bore size	[in.]
$P'$ : Operating air pressure	[psi. = lbf./in. <sup>2</sup> ]
$L$ : Shock absorber stroke	m [ft.]
$h$ : Height of fall	m [ft.]
$T$ : Torque	N·m
$T'$ : Torque	[ft·lbf]
$\omega$ : Angular velocity (90° = 1.57rad.)	rad/s
$N$ : Rotating speed $\omega = 2 \pi N / 60$	rpm
$R$ : Distance from center of rotation to point of impact	m [ft.]
$I$ : Inertia moment relating to center of gravity	kg·m <sup>2</sup>
$I'$ : Inertia moment relating to center of gravity	[ft·lbf·sec <sup>2</sup> ]

# SHOCK ABSORBERS

## ADJUSTABLE ABSORPTION CAPACITY TYPE

### KSHE, KSH Series

### Specifications

Item	Model	Multi orifice type					Single orifice type				
		KSHE5×8	KSHE6×10	KSHE8×15	KSHE10×20	KSHE12×22	KSH5×8	KSH6×10	KSH8×10	KSH10×15	KSH12×22
Maximum absorption J [ft·lbf]		1.5 [1.11]	3.0 [2.21]	9.8 [7.23]	14.7 [10.84]	29.4 [21.69]	1.5 [1.11]	3.0 [2.21]	5.9 [4.35]	9.8 [7.23]	24.5 [18.07]
Absorbing stroke mm [in.]		8 [0.31]	10 [0.39]	15 [0.59]	20 [0.79]	22 [0.87]	8 [0.31]	10 [0.39]	10 [0.39]	15 [0.59]	22 [0.87]
Maximum impact speed m/s [ft./sec.]		1.5 [4.92]					1.0 [3.28]				
Maximum operating frequency cycle/min		60					30				
Spring return force <sup>Note</sup> N [lbf.]		5.6 [1.26]	9.2 [2.07]	10.7 [2.41]	14.4 [3.24]	16.3 [3.66]	5.6 [1.26]	9.2 [2.07]	15.7 [3.53]	16.6 [3.73]	37.1 [8.34]
Angle variation		3° or less					3° or less				
Operating temperature range °C [°F]		0~60 [32~140]					0~60 [32~140]				

Note: Values when compressed.

### Mass

Model	Item	Body Mass	Additional mass			
			Side mounting bracket	Flange mounting bracket	Stopper nut	With cap
KSHE5×8	KSH5×8	24 [0.85]	15 [0.53]	16 [0.56]	7 [0.25]	1 [0.035]
KSHE6×10	KSH6×10	43 [1.52]	22 [0.78]	15 [0.53]	8 [0.28] (12 [0.42])	1 [0.035]
		90 [3.17]			19 [0.67] (30 [1.06])	
KSHE8×15	KSH8×10	102 [3.60]	68 [2.40]	28 [0.99]	4 [0.14]	4 [0.14]
		130 [4.59]			34 [1.20] (50 [1.76])	
KSHE10×20	KSH10×15	144 [5.08]	110 [3.88]	57 [2.01]	5 [0.18]	8 [0.28]
		192 [6.77]			46 [1.62] (69 [2.43])	
KSHE12×22	KSH12×22	200 [7.05]	140 [4.94]	54 [1.90]	8 [0.28]	8 [0.28]

Note: Values in parentheses ( ) are for with cap models.

Remarks : 1. The body is equipped with two mounting nuts.

2. For side mounting bracket, supplied with two mounting screws.

Calculation sample: The mass of KSHE10×20 with side mounting bracket, stopper nut and cap is  
144+110+50+5=309 g [10.90 oz.]

### Order Codes

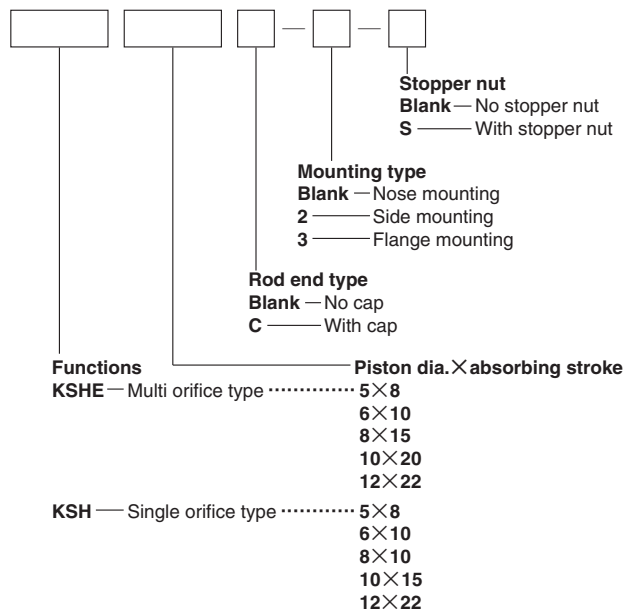

- Mounting bracket and stopper nut are included at time of delivery.
- The mounting screws are included with the side mounting bracket.
- Stopper nut dimensions differ between with rod end cap and no cap type.

### Inner Construction and Major Parts

The illustration shows multi orifice type : For KSHE□×□.

#### Not in operation

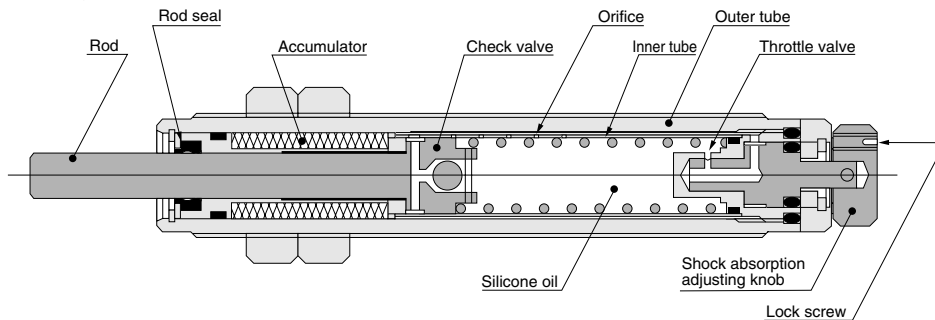

#### In operation

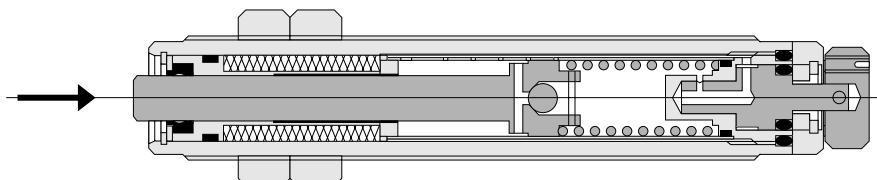

# Selection Guideline

## Precautions for Use of Selection Graphs

1. The selection graphs show the best conditions for usage of the product with horizontal impacts.
2. The selection graphs are calculated for a cylinder with air pressure of 0.5 MPa [73 psi].

### ● Selection Graphs

**KSH (For low speed)**

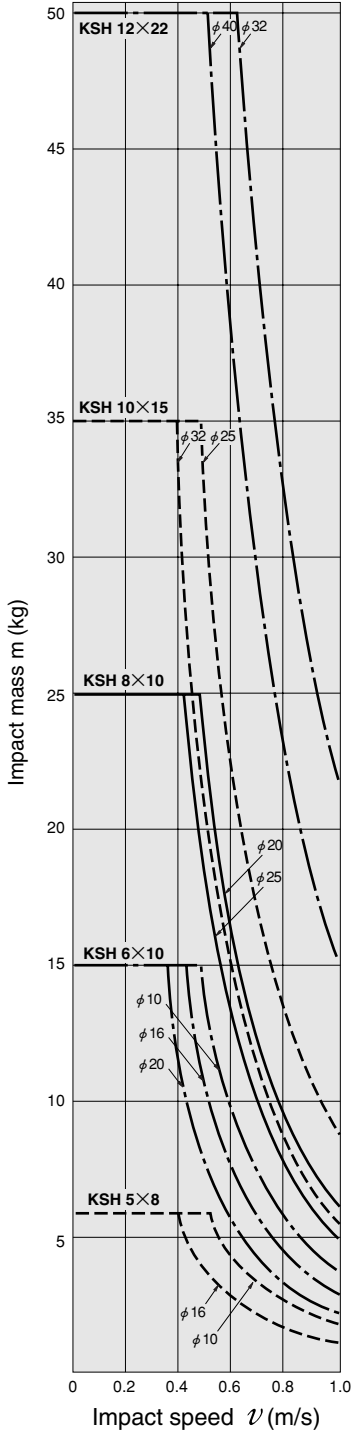

**KSHE (For high speed)**

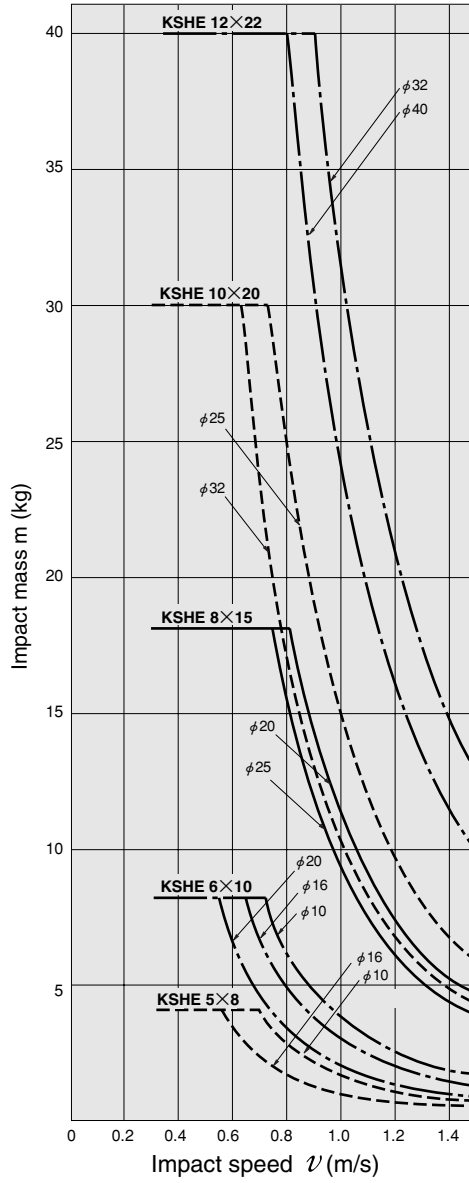

1 kg = 2.20 lb. 1 m/s = 3.28 ft./sec.



## Dimensions (mm)

### ● Nose mounting

● No rod end cap  
KSHE□×□, KSH□×□



KSH Piston dia. × absorbing stroke

● With rod end cap  
KSHE□×□C

KSHE5×8C  
KSH□×□C



S-CAP

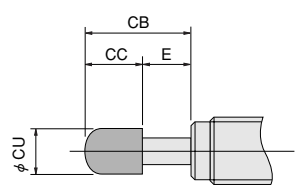
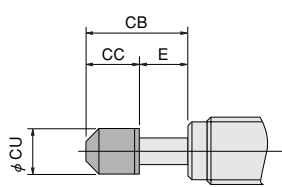
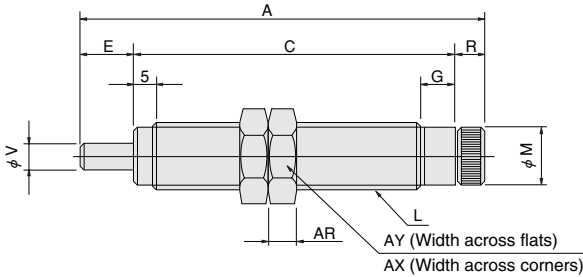

Model	Code	A	C	E	G	L	M	R	V	AR	AX	AY	CB	CC	CU
KSHE5×8□	KSH5×8□	68	55	8	4	M10×1	9	5	3	3	13.9	12	16	8	8
KSHE6×10□	KSH6×10□	78	61	10	10	M12×1	11	7	3	4	16.2	14	20	10	10
	KSH8×10□	92	75	10	10	M16×1.5	13	7	5	7	21.9	19	25	15	12
KSHE8×15□	KSH10×15□	101.5	79.5	15	10	M16×1.5	13	7	5	7	21.9	19	30.5	15.5	13
	KSH10×15□	114	92	15	10	M18×1.5	15	7	6	8	25.4	22	30	15	14
KSHE10×20□		115	88	20	10	M18×1.5	15	7	5	8	25.4	22	35.5	15.5	15
KSHE12×22□		120	91	22	10	M20×1.5	17	7	5	10	27.7	24	40	18	16
	KSH12×22□	147	118	22	10	M20×1.5	17	7	6	10	27.7	24	40	18	16

### Dimensions of Mounting Bracket (mm)

#### ● Side mounting bracket : -2



S-SIDE

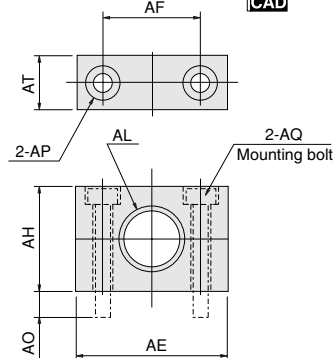

Model	Code	AE	AF	AH	AL	AO
For KSHE 5×8□	For KSH 5×8□	22	14	14	M10×1 Counterbore φ 10.2 Depth2	( 9.3)
For KSHE 6×10□	For KSH 6×10□	25	16	18	M12×1 Counterbore φ 12.2 Depth2	( 5.3)
For KSHE(S) 8×15□ <sup>Note</sup>	For KSH 8×10□	38	25	25	M16×1.5	( 7.4)
For KSHE(S) 10×20□ <sup>Note</sup>	For KSH10×15□	50	34	30	M18×1.5	(11.5)
For KSHE(S) 12×22□ <sup>Note</sup>	For KSH12×22□	50	34	30	M20×1.5	(13.6)

Model	Code	AP	AQ (Hexagon socket head screw)	AT
For KSHE 5×8□	For KSH 5×8□	φ 3.4 Counterbore φ 6.2 Depth3.3	M3×0.5 Screw length 20	9
For KSHE 6×10□	For KSH 6×10□	φ 3.4 Counterbore φ 6.2 Depth3.3	M3×0.5 Screw length 20	9
For KSHE(S) 8×15□ <sup>Note</sup>	For KSH 8×10□	φ 4.5 Counterbore φ 8 Depth4.4	M4×0.7 Screw length 28	12
For KSHE(S) 10×20□ <sup>Note</sup>	For KSH10×15□	φ 6.5 Counterbore φ 11 Depth6.5	M6×1 Screw length 35	12
For KSHE(S) 12×22□ <sup>Note</sup>	For KSH12×22□	φ 9 Counterbore φ 14 Depth8.6	M8×1.25 Screw length 35	16

● Mounting screws (hexagon socket head screws) are supplied with side mounting bracket.  
Note: For KSHES (shock absorbers with sensor switch), see p.595.

#### ● Flange mounting bracket : -3



S-FLANGE

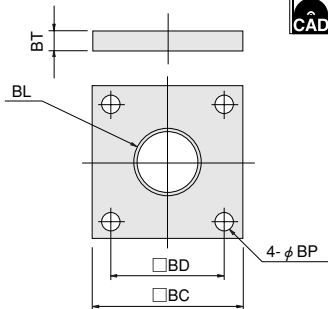

Model	Code	BC	BD	BL	BP	BT
For KSHE 5×8□	For KSH 5×8□	25	18	M10×1 Counterbore φ 10.2 Depth1.7	3.2	4
For KSHE 6×10□	For KSH 6×10□	25	18	M12×1 Counterbore φ 12.2 Depth1.7	3.2	4
For KSHE(S) 8×15□ <sup>Note</sup>	For KSH 8×10□	34	24	M16×1.5	4.5	4
For KSHE(S) 10×20□ <sup>Note</sup>	For KSH10×15□	40	28	M18×1.5	6.5	6
For KSHE(S) 12×22□ <sup>Note</sup>	For KSH12×22□	40	28	M20×1.5	6.5	6

Note: For KSHES (shock absorbers with sensor switch), see p.595.

#### ● Stopper nut : -S



S-STOPER

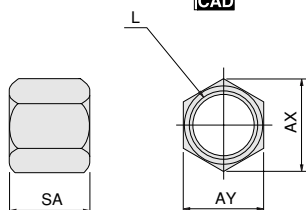

Model	Code	L	AX	AY	SA
For KSHE 5×8	For KSH 5×8	M10×1	13.9	12	17
For KSHE 5×8C	For KSH 5×8C				
For KSHE 6×10	For KSH 6×10	M12×1	16.2	14	17
For KSHE 6×10C	For KSH 6×10C				
For KSHE 8×15	For KSH 8×10	M16×1.5	21.9	19	20
For KSHE 8×15C	For KSH 8×10C				
For KSHE10×20	For KSH10×15	M18×1.5	25.4	22	25
For KSHE10×20C	For KSH10×15C				
For KSHE12×22	For KSH12×22	M20×1.5	27.7	24	30
For KSHE12×22C	For KSH12×22C				