

KOGANEI

ACCESSORIES GENERAL CATALOG

AIR TREATMENT, AUXILIARY, VACUUM,
AND FLUORORESIN PRODUCTS

POWER REDUCERS CONTENTS



Specifications, Order Codes, Size Table	481
Dimensions	482
Flow Rate Characteristics	483
NCU Specification Order Codes, Model Table	484
Safety Precautions, Handling Instructions and Precautions	485

POWER REDUCERS

- Control the supply and exhaust pressure for actuators.
- When high pressure operation of actuators is required, the power reducer saves the compressed air by reducing pressure only when the actuator returns to its starting position of operation.

Symbol

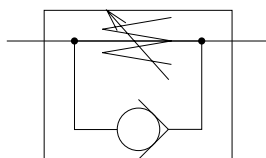

Specifications

Media	Air
Operating pressure range	0~0.9MPa [0~131psi.]
Pressure setting range	0.2~0.6MPa [29~87psi.]
Operating temperature range	0~60°C [32~140°F]
Recommended tube	Nylon tube, urethane tube
Sales unit	1 pc.

Inner Construction, Major Parts and Materials

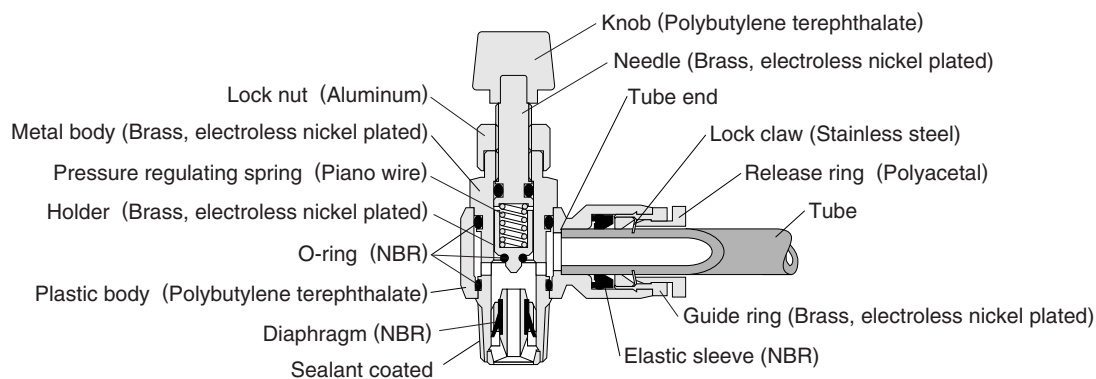

Order Codes

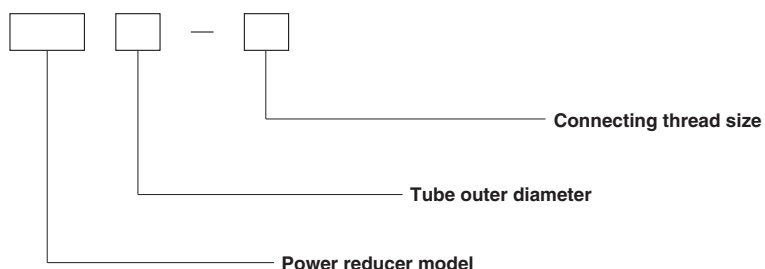

※ For the fitting models, the tube size, and thread size combinations, see the tables below.

- For the NCU specification, see p.484.

● TPS Straight 482



Tube size	Thread size				
	M5×0.8	R1/8	R1/4	R3/8	R1/2
4	M5	01	—	—	—
6	M5	01	02	—	—
8	—	01	02	03	—
10	—	—	02	03	—
12	—	—	—	03	04

● TPL Elbow 482



Tube size	Thread size				
	M5×0.8	R1/8	R1/4	R3/8	R1/2
4	M5	01	—	—	—
6	M5	01	02	—	—
8	—	01	02	03	—
10	—	—	02	03	—
12	—	—	—	03	04

Dimensions (mm)

Straight TPS

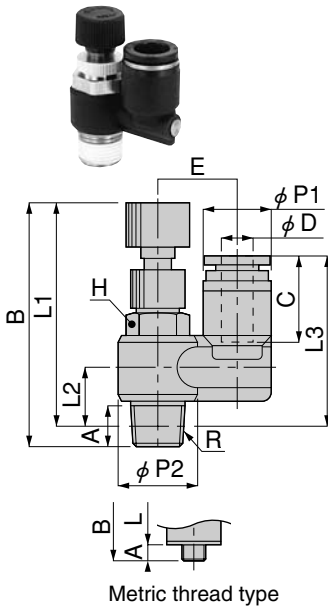

Model	Tube outer diameter ϕ D	R	A	B		L1 ^{Note}		L2 ^{Note}	L3 ^{Note}	ϕ P1	ϕ P2	C	E	Width across flats H	Mass (g) [oz.]
				MAX	MIN	MAX	MIN								
TPS4-M5	4	M5X0.8	2.9	38.3	35.2	35.4	32.3	6.7	23.8	10.2	9.8	14.9	10.5	8	9.5 [0.335]
TPS4-01		R1/8	8	48.2	43.7	44.2	39.7	10.9	28.9		14.4		13	10	21 [0.74]
TPS6-M5	6	M5X0.8	2.9	38.3	35.2	35.4	32.3	6.7	25.9	12.6	9.8	17	12.2	8	11 [0.39]
TPS6-01		R1/8	8	48.2	43.7	44.2	39.7	10.9	31		14.4		14.2	10	22 [0.78]
TPS6-02	R1/4	11.1	52.3	47.8	46.2	41.8	12	32.1	14.6	18.4	18.1	17.2	14	38 [1.34]	
TPS8-01	R1/8	8	48.2	43.7	44.2	39.7	10.9	32.4		14.4		15.2	10	23 [0.81]	
TPS8-02	R1/4	11.1	52.3	47.8	46.2	41.8	12	33.6	22	18.4	20.2	18.2	14	39 [1.38]	
TPS8-03	R3/8	13.2	59	54.5	52.6	48.2	15.4	37.8		19.2		19	70 [2.47]		
TPS10-02	10	R1/4	11.1	52.3	47.8	46.2	41.8	12	35.9	17.8	18.4	20.2	19.8	14	43 [1.52]
TPS10-03		R3/8	13.2	59	54.5	52.6	48.2	15.4	40.1		22		20.8	19	74 [2.61]
TPS12-03	12	R3/8	13.2	59	54.5	52.6	48.2	15.4	42.8	21.2	22	23.4	22.5	24	78 [2.75]
TPS12-04		R1/2	16	64.3	59.8	56.1	51.6	18.2	47		28		25.5	110 [3.88]	

Note: The L1, L2 and L3 dimensions for the taper thread type are the reference dimensions after the fittings are assembled.

Elbow TPL

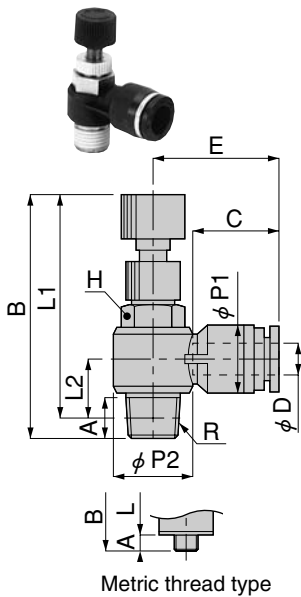

Model	Tube outer diameter ϕ D	R	A	B		L1 ^{Note}		L2 ^{Note}	ϕ P1	ϕ P2	C	E	Width across flats H	Mass (g) [oz.]
				MAX	MIN	MAX	MIN							
TPL4-M5	4	M5X0.8	2.9	38.3	35.2	35.4	32.3	7.1	9.9	9.8	14.9	19.9	8	8.9 [0.314]
TPL4-01		R1/8	8	48.2	43.7	44.2	39.7	9.7	10	14.4		21.4	10	20 [0.71]
TPL6-M5	6	M5X0.8	2.9	38.3	35.2	35.4	32.3	8.3	12.4	9.8	17	24	8	8.9 [0.314]
TPL6-01		R1/8	8	48.2	43.7	44.2	39.7	10.9		14.4		23.5	10	20 [0.71]
TPL6-02	R1/4	11.1	52.3	47.8	46.2	41.8	12.2	14.4	18.4	18.1	25.5	14	36 [1.27]	
TPL8-01	R1/8	8	48.2	43.7	44.2	39.7	11.9		14.4		26.9	10	22 [0.78]	
TPL8-02	R1/4	11.1	52.3	47.8	46.2	41.8	13.2	17.6	18.4	20.2	28.4	14	38 [1.34]	
TPL8-03	R3/8	13.2	59	54.5	52.6	48.2	15.4		22		28.9	19	68 [2.40]	
TPL10-02	10	R1/4	11.1	52.3	47.8	46.2	41.8	14.8	21	18.4	23.4	30.9	14	41 [1.45]
TPL10-03		R3/8	13.2	59	54.5	52.6	48.2	16.7		22		31.2	19	71 [2.50]
TPL12-03	12	R3/8	13.2	59	54.5	52.6	48.2	18.4	28	22	23.4	36.9	24	75 [2.65]
TPL12-04		R1/2	16	64.3	59.8	56.1	51.6	19.7		28		36.4	104 [3.67]	

Note: The L1 and L2 dimensions for the taper thread type are the reference dimensions after the fittings are assembled.

Functions

When primary pressure applies to the thread side, the pressure is reduced and the air flows out through the fitting side.

When primary pressure is applied to the fitting side, the built-in check valve activates and sends the flow through the thread side without reducing the pressure.

When high pressure operation of actuators is required, the power reducer saves the compressed air by reducing pressure only when the actuator returns to its starting position of operation.

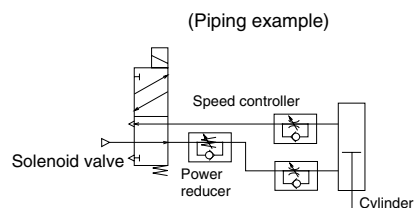
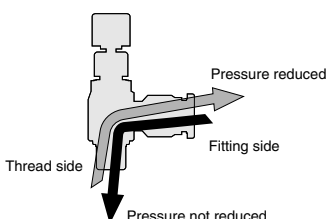

Note: There is an increased risk of the cylinder rod popping out when the pressure difference between the cylinder's rod side and head side becomes larger.

Flow Rate Characteristics

TPS4-M5 TPL4-M5
TPS6-M5 TPL6-M5

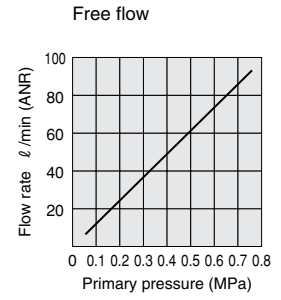
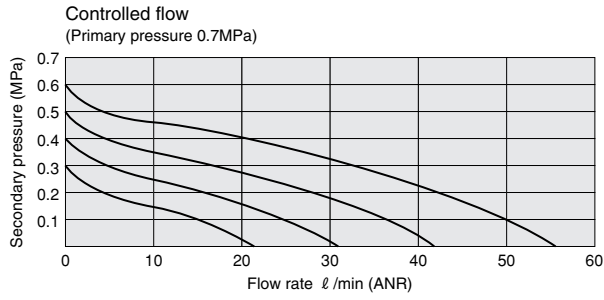

1MPa = 145psi. 1 ℓ/min = 0.0353ft³/min.

TPS4-01 TPL4-01
TPS6-01 TPL6-01
TPS8-01 TPL8-01

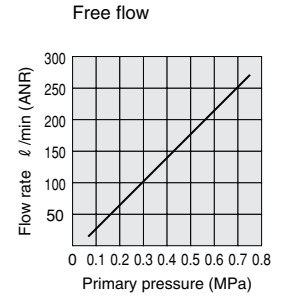
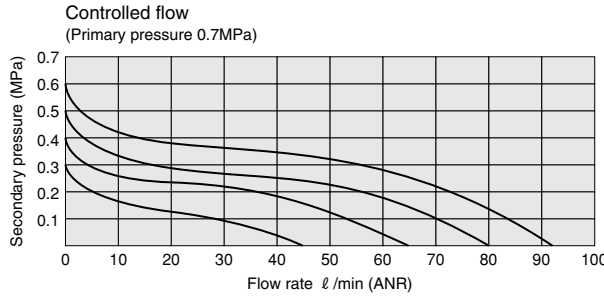

1MPa = 145psi. 1 ℓ/min = 0.0353ft³/min.

TPS6-02 TPL6-02
TPS8-02 TPL8-02
TPS10-02 TPL10-02

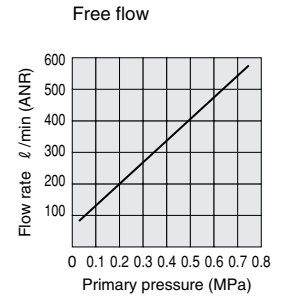
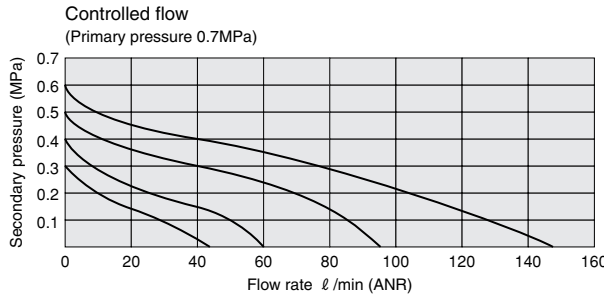

1MPa = 145psi. 1 ℓ/min = 0.0353ft³/min.

TPS8-03 TPL8-03
TPS10-03 TPL10-03
TPS12-03 TPL12-03

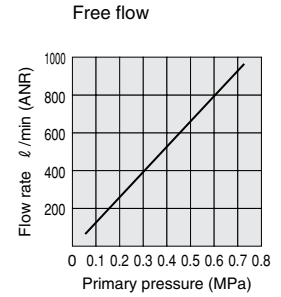
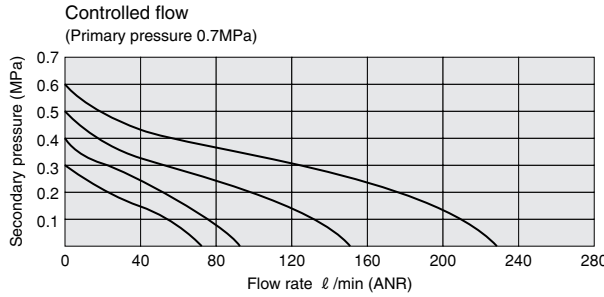

1MPa = 145psi. 1 ℓ/min = 0.0353ft³/min.

TPS12-04 TPL12-04

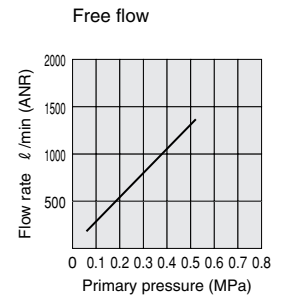
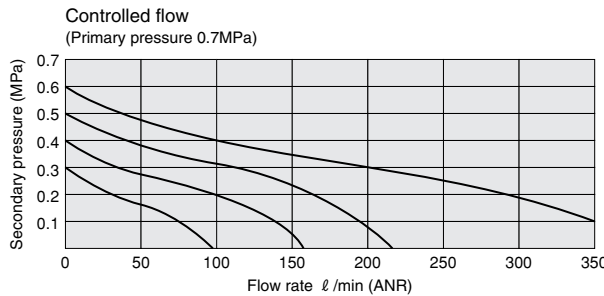

1MPa = 145psi. 1 ℓ/min = 0.0353ft³/min.

POWER REDUCERS

NCU Specification

- For specifications, see p.481.
- The dimensions, inner construction, major parts and materials for the **NCU** specification shown below are the same as the standard type. See inner construction, major parts and materials on p.481 and dimensions on p.482.
The sealant is not applied to the R taper thread section.

Caution: For delivery, consult us.

NCU Specification

● Order Codes

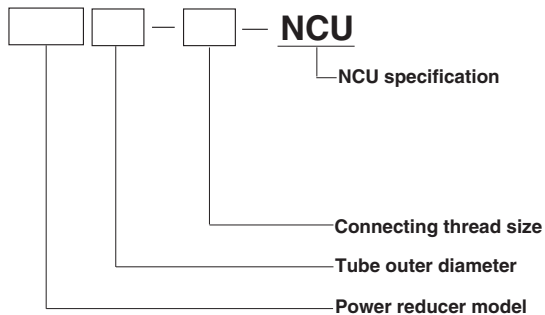

※ For the fitting models, the tube size, and thread combinations, see the table below. Columns showing the “←” symbol indicate that standard products can be used as the NCU specification. In these cases, place orders for the standard products.

● Model Table (NCU Specification)

Fitting type	Tube outer diameter	Thread	Standard type model (reference)	NCU specification model
Straight TPS	4	M5×0.8	TPS4-M5	←
		R1/8	TPS4-01	TPS4-01-NCU
	6	M5×0.8	TPS6-M5	←
		R1/8	TPS6-01	TPS6-01-NCU
		R1/4	TPS6-02	TPS6-02-NCU
	8	R1/8	TPS8-01	TPS8-01-NCU
		R1/4	TPS8-02	TPS8-02-NCU
		R3/8	TPS8-03	TPS8-03-NCU
	10	R1/4	TPS10-02	TPS10-02-NCU
		R3/8	TPS10-03	TPS10-03-NCU
	12	R3/8	TPS12-03	TPS12-03-NCU
		R1/2	TPS12-04	TPS12-04-NCU
Elbow TPL	4	M5×0.8	TPL4-M5	←
		R1/8	TPL4-01	TPL4-01-NCU
	6	M5×0.8	TPL6-M5	←
		R1/8	TPL6-01	TPL6-01-NCU
		R1/4	TPL6-02	TPL6-02-NCU
	8	R1/8	TPL8-01	TPL8-01-NCU
		R1/4	TPL8-02	TPL8-02-NCU
		R3/8	TPL8-03	TPL8-03-NCU
	10	R1/4	TPL10-02	TPL10-02-NCU
		R3/8	TPL10-03	TPL10-03-NCU
	12	R3/8	TPL12-03	TPL12-03-NCU
		R1/2	TPL12-04	TPL12-04-NCU

Safety Precautions (Power Reducers)

The following is a safety precaution to Power Reducers. For other safety precautions, be sure to read the precautions on p.49.

Warning

- Do not force products to rotate or swing even if the plastic body is rotatable. Such application could cause damage or leakage in the body.
- Avoid using Power Reducers as the safety valve, which requires accuracy. The Power Reducer is not designed for safety valve applications.
- Do not use a mechanical tool to tighten the lock nut; instead, manually tighten the lock nut firmly in place. Using a mechanical tool to tighten could result in damage to the lock nut or the body. Also, if the lock nut is not firmly tightened, it could become loose, causing the initial setting to shift the position.

Handling Instructions and Precautions

● Mounting

Precautions for mounting the body

1. To mount the body, use a suitable tool to tighten it to the outer hexagonal section of the body.
2. When tightening body thread, tighten to the recommended tightening torque shown in the table below. Tightening to more than the recommended torque could result in broken thread sections or air leaks due to deformed gaskets. Tightening to less than the recommended torque could lead to loose body thread or air leaks.

Recommended tightening torque

Thread type	Thread	Tightening torque
Metric thread	M5×0.8	1.5~1.9N·m [1.11~1.40ft·lbf]
Taper pipe thread	R1/8	7~9N·m [5.2~6.6ft·lbf]
	R1/4	12~14N·m [8.9~10.3ft·lbf]
	R3/8	22~24N·m [16.2~17.7ft·lbf]
	R1/2	28~30N·m [20.7~22.1ft·lbf]

Precautions for disconnecting the body

1. To disconnect the body, use a suitable tool to loosen it from the outer hexagonal section of the body.
2. Clean off the sealant coating on the thread of the removed mating part. The coated sealant could enter other relating parts, and cause breakdowns.

Method for tightening body thread

1. Tightening body thread
For tightening body thread, use a wrench on outer hexagonal section.

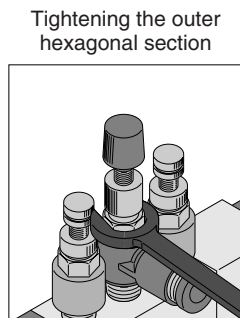

● Connecting and disconnecting tube

Precautions for connecting a tube

1. Check that the tube cut surface is perpendicular to the tube length, that there is no scratch on the outside of the tube, and that the tube shape has not become elliptical.
2. When connecting tubes, failure to push the tube in all the way to the tube end could result in leaks.

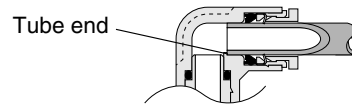

3. After connection, check that the tube cannot be pulled out.

Precautions for disconnecting the tube

1. When releasing a tube, always check that pressure inside the tube is at zero.
2. Push the release ring evenly all the way to the end, and then pull the tube out. An insufficient push could make it impossible to pull the tube out, or could scratch the tube, leaving scratched tube material inside the fitting.

Tube connection and disconnection method

1. Tube connection
The Power Reducer is equipped with a lock claw that holds the tube in place when it has been pushed all the way to the end, and with an elastic sleeve for sealing the tube periphery.

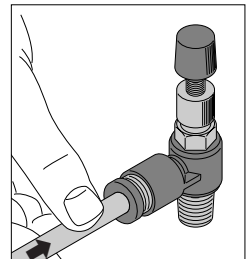

2. Tube disconnection
To disconnect the tube, first push on the release ring, releasing the lock claw, and then pull out the tube. Always stop the air supply before removing the tube.

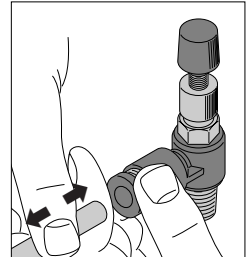

Handling Instructions and Precautions

● Usable tubes

Either a nylon tube or urethane tube can be used. For the tube outer diameter precision, use a nylon tube with nominal dimension of ± 0.1 mm [± 0.004 in.] or less, and a urethane tube with nominal dimension of ± 0.15 mm [± 0.0059 in.] or less, while the degree of ellipticity (difference between long diameter and short diameter) should be 0.2 mm [0.008 in.] or less.

- Cautions:**
1. Use a tube without scratches on the outer surface. If scratches appear due to repeated use, cut off that portion.
 2. Do not excessively bend or twist the tube near the fitting. It could be the cause of air leaks. If using a nylon tube, see the table below for the minimum bending radius.

Tube size	Minimum bending radius	mm [in.]
ϕ 4 [0.157]	20 [0.8]	
ϕ 6 [0.236]	30 [1.2]	
ϕ 8 [0.315]	50 [2.0]	
ϕ 10 [0.394]	80 [3.2]	
ϕ 12 [0.472]	150 [5.9]	

For cases where tight or cramped piping spaces hinder tube removal operations, a special tool is available. Consult us for details.

Special tool for tube removal

For ϕ 3 [0.118in.], ϕ 4 [0.157in.] and ϕ 6 [0.236in.] tubes
Order code: **UJ-1**



For ϕ 6 [0.236in.], ϕ 8 [0.315in.], ϕ 10 [0.394in.] and ϕ 12 [0.472in.] tubes

Order code: **UJ-2**



● Regulating pressure

1. When increasing pressure
From the fully closed position, turning the power reducer's pressure regulating knob in the counterclockwise direction raises the pressure. When the desired pressure is attained, be sure to tighten the lock nut to ensure that the speed setting does not shift the position.

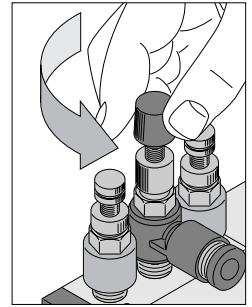

2. When reducing pressure
If the power reducer's pressure regulating knob has been turned too far (the pressure has risen too high), turning it in the clockwise direction reduces the pressure. When the desired pressure is attained, be sure to tighten the lock nut to ensure that the speed setting does not shift the position.

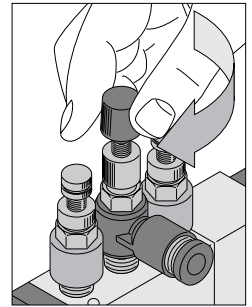

- Cautions:**
1. To set the pressure, start from the needle's fully closed position and rotate it counterclockwise. Since there is no relief mechanism, the pressure cannot be set from the fully opened position. When resetting the pressure, exhaust the secondary pressure first, before proceeding to reset.
 2. Since fluctuation of primary pressure causes fluctuation in the secondary pressure, proceed with caution when the primary pressure fluctuation is large.