

## Micro Ejector Order Codes

### ● Micro ejector single unit (without solenoid valve)

**ME**

**Body model** nozzle diameter : Maximum flow rate on vacuum side

**03**  $\phi$  0.3 : 3.0 l /min. [  $\phi$  0.012in., 0.106ft.<sup>3</sup>/min.] (ANR)

**05**  $\phi$  0.5 : 6.3 l /min. [  $\phi$  0.020in., 0.222ft.<sup>3</sup>/min.] (ANR)

**07**  $\phi$  0.7 : 12.5 l /min. [  $\phi$  0.028in., 0.441ft.<sup>3</sup>/min.] (ANR)

Micro ejector

### ● Micro ejector with solenoid valve

**Voltage**

**DC12V** (only for ME03-E1)

**DC24V**

**AC100V** (only for ME05 and 07)

**AC200V** (only for ME05 and 07)

**Solenoid**

**Blank** Grommet

**PSL** <sup>Note 2</sup> Straight connector (with LED indicator)

**PLL** <sup>Note 2</sup> L connector (with LED indicator)

**Manual override**

**Blank** Non-locking type

**83** Protruding locking type (only for ME05 and 07)

**Solenoid valve function**<sup>Note 1</sup>

**Blank** Normally closed (NC)

**11** Normally open (NO)

**Solenoid valve specifications**

**E1** With single solenoid valve for controlling supply air

**E2** With twin solenoid valves for controlling supply air and vacuum breaking air (only for AME05 and 07)

**Body model** nozzle diameter : Maximum flow rate on vacuum side

**03**  $\phi$  0.3 : 3.0 l /min. [  $\phi$  0.012in., 0.106ft.<sup>3</sup>/min.] (ANR)

**05**  $\phi$  0.5 : 6.3 l /min. [  $\phi$  0.020in., 0.222ft.<sup>3</sup>/min.] (ANR)

**07**  $\phi$  0.7 : 12.5 l /min. [  $\phi$  0.028in., 0.441ft.<sup>3</sup>/min.] (ANR)

Micro ejector

**ME** For single unit

**AME** For manifold mounting

Notes: 1. Only for solenoid valve for controlling supply air. The solenoid valve for controlling vacuum breaking air is normally closed (NC) only.

2. Lead wires in the **1L**: 1000mm [39in.] and **3L**: 3000mm [118in.] lengths are available as made to order for the plug connector type.

## Electronic Vacuum Switch Order Codes

**DC24V**

**Lead wire length**

**Blank** 500mm

**L** 2000mm

Switch for DC12~24V

Electronic vacuum switch

**PS310** Only body

**PS310E** For mounting on AS type manifold (with gasket and spring pin)

**PS310E-01** For mounting on a single unit (R1/8 male thread specification)

## Manifold Order Codes

**Electronic vacuum switch**

**Blank** No vacuum switch

**E** With vacuum switch<sup>Note 2</sup> (only for AS type manifold)

**Mounting micro ejector model**<sup>Note 1</sup>

**AME03-E1** -

**AME05-E**

**AME07-E**

**Station**

(The micro ejector mounting positions are listed from the left with the vacuum generation port in front.)

**stn.1** Station 1

**stn.2** Station 2

**:**

**stn.5** Station 5

**Manifold model**

**A** A type manifold (P, V manifold)

**AS** AS type manifold (P, V manifold for mounting vacuum switch, only for ME05M and ME07M)

**Number of units**

**1** One unit

**2** Two units

**:**

**5** Five units

**Manifold basic model**

**ME03M** For mounting AME03-E1

**ME05M** For mounting AME05-E

**ME07M** For mounting AME07-E

Notes: 1. For mountings of micro ejector options, see the micro ejector order codes. Also, if not mounting a micro ejector, and placing a block-off plate on the station instead, enter **-BP**.

2. Lead wires in the **2000mm** [79in.] length are available as made to order for the electronic vacuum switch.

## Additional Parts (to be ordered separately)

### ● Block-off plate

**ME**  **MA-BP**

**03** For ME03M

**05** For ME05M

**07** For ME07M

### ● Replacement filter

**ME**  **MA-F**

**03** For ME03M

**05** For ME05M

**07** For ME07M

# Operation Principle and Major Parts

## ● De-energized

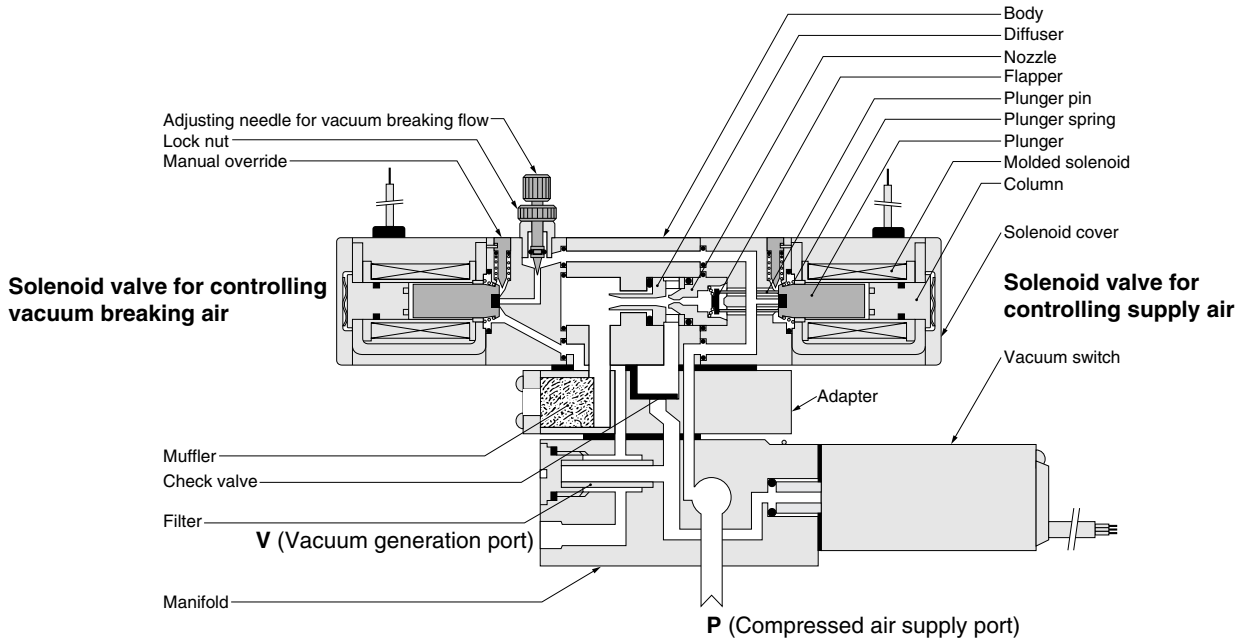

## ● When energizing a solenoid valve for controlling supply air (generating vacuum)

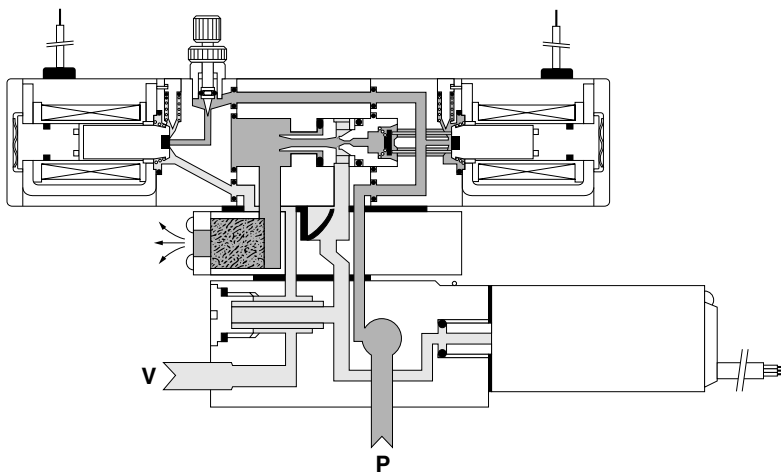

## ● When energizing solenoid valve for controlling vacuum breaking air

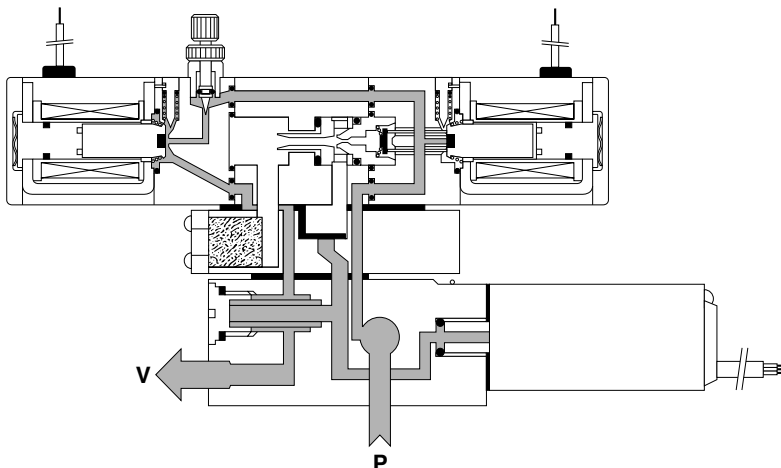

### Major Parts and Materials

Parts		Materials
Micro ejector	Body	Aluminum alloy (anodized)
	Adapter	Aluminum alloy (anodized)
	Nozzle, diffuser	Brass
	O-ring	Synthetic rubber (NBR)
	Gasket	Synthetic rubber (NBR)
	Plunger	Magnetic stainless steel
Manifold	Column	Magnetic stainless steel
	Body	Aluminum alloy (anodized)
	Seal	Synthetic rubber (NBR)
	Filter	Plastic (PVF)
	Block-off plate	Mild steel (nickel plated)

# Symbols

## Single unit

●ME03 ●ME05 ●ME07

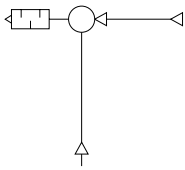

## With single solenoid valve

●ME03-E1 ●ME05-E1 ●ME07-E1

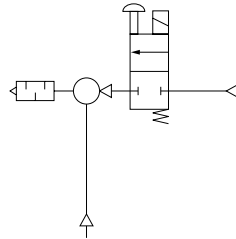

## With single solenoid valve

●AME03-E1 ●AME05-E1 ●AME07-E1  
(Manifold mounted)

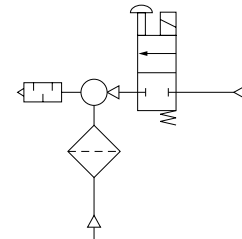

## With single solenoid valve and vacuum switch

●AME05-E1-□-E ●AME07-E1-□-E  
(AS type manifold mounted)

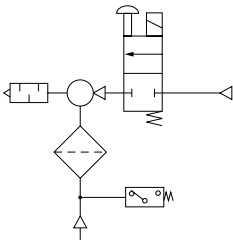

## With twin solenoid valves

●AME05-E2 ●AME07-E2  
(Manifold mounted)

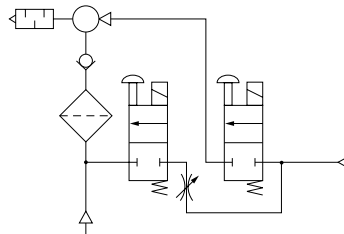

## With twin solenoid valves and vacuum switch

●AME05-E2-□-E ●AME07-E2-□-E  
(AS type manifold mounted)

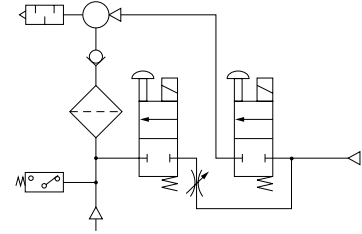

# Mass

## ●Micro ejectors

g [oz.]

Item	Basic model	ME03	ME05	ME07
Without solenoid valve		9 [0.32]	34 [1.20]	52 [1.83]
With single solenoid valve ME□-E1		24 [0.85]	80 [2.82]	103 [3.63]

## ●With electronic vacuum switch

PS310E (For mounting AS type manifold).....21g [0.74oz.]  
PS310E-01 (For mounting single unit).....38g [1.34oz.]

## ●Manifolds

g [oz.]

Item	Model	ME03		ME05		ME07	
		ME03M□A	ME05M□A	ME05M□AS	ME07M□A	ME07M□AS	
Manifold body for number of units	1 unit	26 [0.92]	62 [2.19]	81 [2.86]	120 [4.23]	148 [5.22]	
	2 units	49 [1.73]	118 [4.16]	154 [5.43]	237 [8.36]	292 [10.30]	
	3 units	64 [2.26]	156 [5.50]	202 [7.13]	313 [11.04]	385 [13.58]	
	4 units	80 [2.82]	193 [6.81]	251 [8.85]	389 [13.72]	478 [16.86]	
	5 units	95 [3.35]	231 [8.15]	299 [10.55]	465 [16.40]	571 [20.14]	
Additional mass	With single solenoid valve -AME□-E1	25 [0.88]	83 [2.93]		108 [3.81]		
	With twin solenoid valve -AME□-E2	—	167 [5.89]		216 [7.62]		
	With electronic vacuum switch -E	—	—	21 [0.74]	—	21 [0.74]	
	Block-off plate -BP	2 [0.07]	6 [0.21]		13 [0.46]		

Calculation example : ME05M5AS

stn.1~2-AME05-E1

stn.3~4-AME05-E2-E

stn.5 mass of -BP 299 + (83 × 2) + (167 + 21) × 2 + 6 = 847g [29.88oz.]

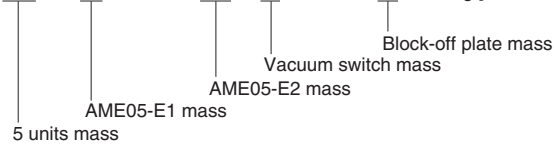

# Dimensions of Electronic Vacuum Switch (mm)

## PS310E-01

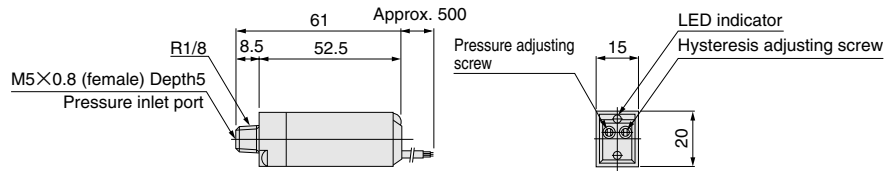

## Air Consumption, Vacuum and Vacuum Flow Rate

### ME03

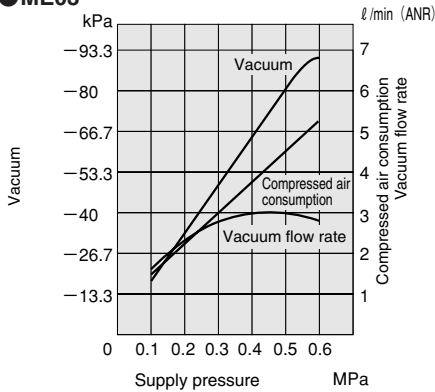

### ME05

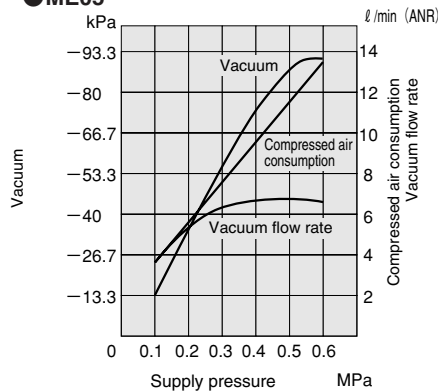

### ME07

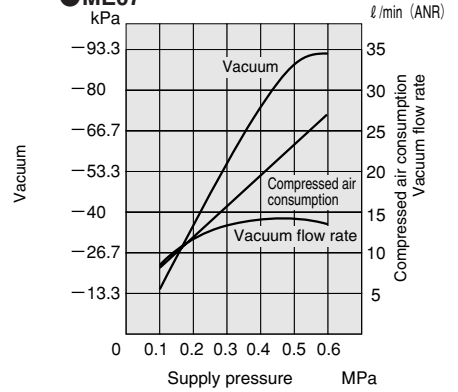

Remark: Graphs are for each single ejector unit. If the unit with solenoid valve requires the same vacuum level, set the supply pressure 0.03~0.05MPa [4.4~7.3psi.] higher than the single ejector unit's case.

1MPa = 145psi. 1kPa = 0.145psi. -100kPa = -29.54in.Hg 1 l/min = 0.0353ft<sup>3</sup>/min.

## Time to Reach Vacuum and Vacuum Breaking Time

### Measurement method

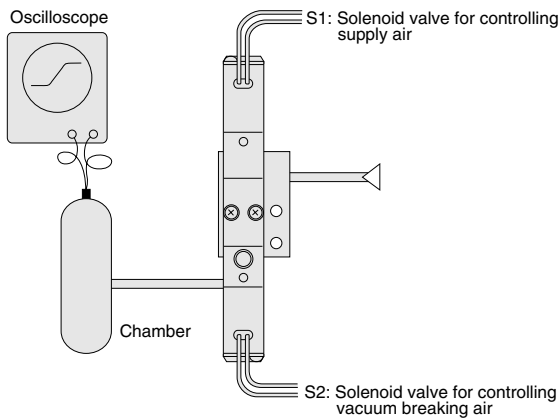

### ME□-E1

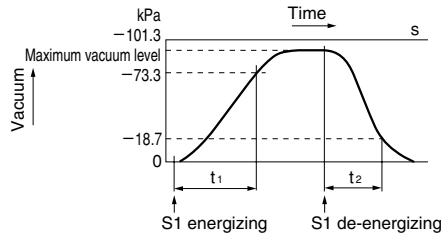

Air pressure: 0.5MPa [73psi.]  
Adjusting needle for vacuum breaking flow: Fully open  
t<sub>1</sub>: Time to reach -73.3kPa [-21.65in.Hg] in the chamber after energizing S1.

t<sub>2</sub>: In ME□-E1, time to reach -18.7 kPa [-5.52in.Hg] in the chamber after de-energizing S1.

### ME□-E2

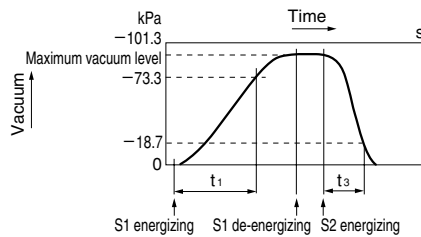

t<sub>3</sub>: In ME□-E2, time to reach -18.7kPa [-5.52in.Hg] in the chamber after energizing S2 and when vacuum was at its maximum level.

### Response time

Model	Chamber capacity cm <sup>3</sup> [in. <sup>3</sup> ]	5 [0.305]			10 [0.610]			20 [1.22]			50 [3.05]			100 [6.10]			200 [12.2]			500 [30.5]		
		t <sub>1</sub>	t <sub>2</sub>	t <sub>3</sub>	t <sub>1</sub>	t <sub>2</sub>	t <sub>3</sub>	t <sub>1</sub>	t <sub>2</sub>	t <sub>3</sub>	t <sub>1</sub>	t <sub>2</sub>	t <sub>3</sub>	t <sub>1</sub>	t <sub>2</sub>	t <sub>3</sub>	t <sub>1</sub>	t <sub>2</sub>	t <sub>3</sub>	t <sub>1</sub>	t <sub>2</sub>	t <sub>3</sub>
ME03		0.4	0.1	—	0.7	0.2	—	1.1	0.3	—	3.2	0.6	—	5.8	1.1	—	—	—	—	—	—	—
ME05		0.2	0.1	0.1	0.3	0.1	0.1	0.5	0.1	0.1	1.5	0.3	0.1	2.6	0.5	0.2	7.0	0.8	0.4	12.0	1.8	0.8
ME07		0.1	0.1	0.1	0.2	0.1	0.1	0.3	0.1	0.1	0.6	0.2	0.1	1.0	0.3	0.2	1.8	0.4	0.4	4.7	1.0	0.8

Note: Some degree of variation may occur due to piping size and chamber shape. The figures can be viewed as a guide.

# Handling Instructions and Precautions

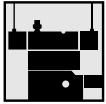

## Micro Ejector

### Device configuration

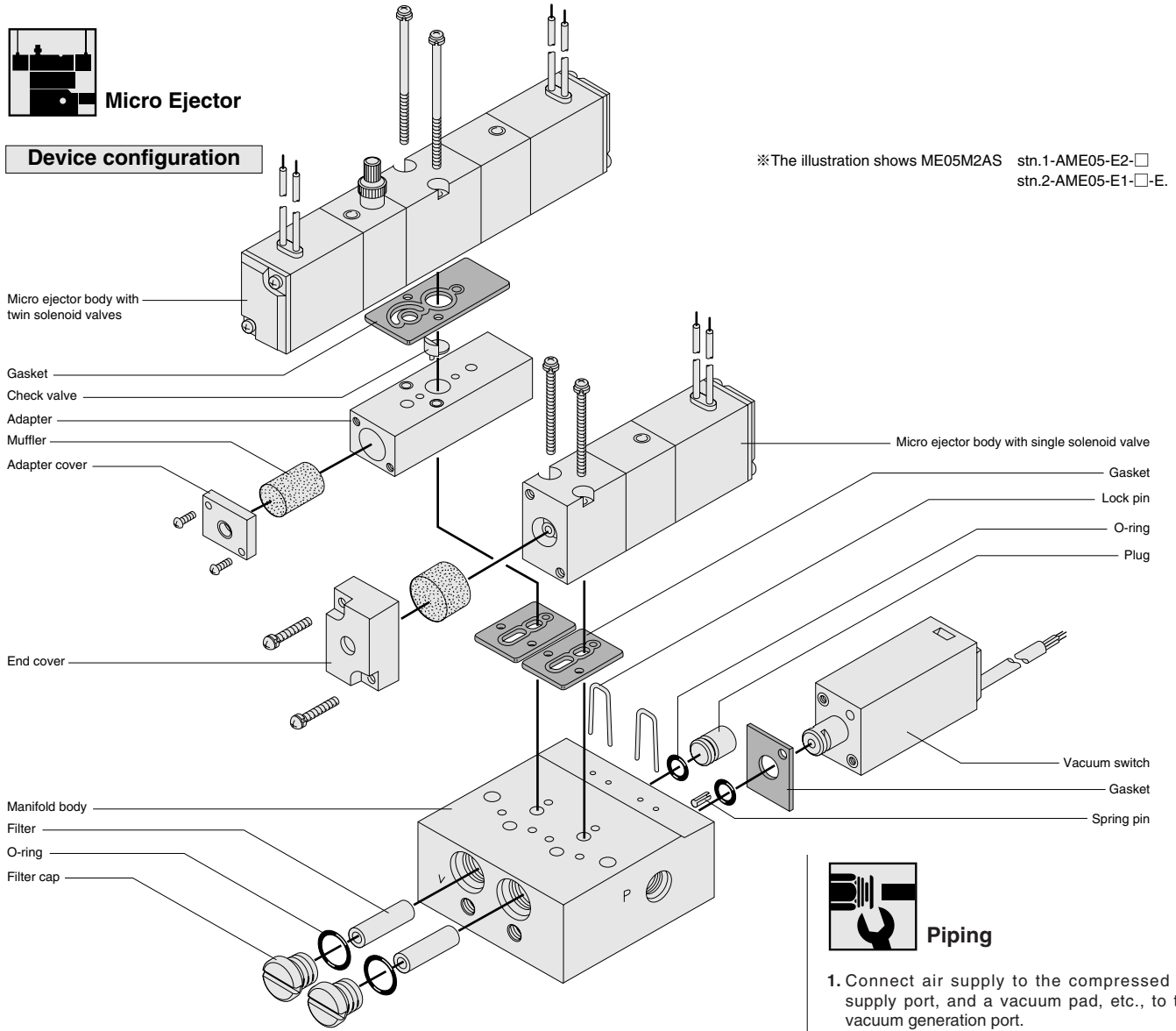

※The illustration shows ME05M2AS stn.1-AME05-E2-□  
stn.2-AME05-E1-□-E.

### Functions

In addition to a single unit, the Micro Ejector ME03/05/07 series offer models with single solenoid valves for controlling supply air, and with twin solenoid valves for controlling supply air and vacuum breaking air (twin solenoid valves are for AME05/07 only). The unit with twin solenoid valves uses supply of pressurized air to the vacuum side to enable vacuum breaking and blow-off release, and makes use of an adjusting needle for vacuum breaking flow to enable flexible setting of breaking flow. In addition, a built-in check valve ensures that the setting of vacuum level can be maintained even when the power to the solenoid valve for controlling supply air has been switched off, attaining energy savings.

### ●Control circuit for economizing on air consumption volume when the vacuum is being maintained for long periods of time

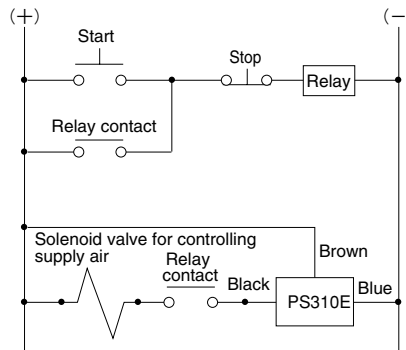

Remark: The above diagram shows the case when the solenoid valve for controlling supply air is normally open (NO; order code: -11).

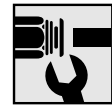

### Piping

1. Connect air supply to the compressed air supply port, and a vacuum pad, etc., to the vacuum generation port.
2. In manifolds with two or more units, P ports (compressed air supply ports) are located on both ends of the manifold, and the piping direction can be selected according to the mounting location. At time of delivery, a port on one side is temporarily blocked off with a plug. Remove the plug and then use sealing tape or other sealing material to re-tighten.
3. Use a block-off plate (order code: ME□MA-BP) to block off unused stations on the manifold.
4. For piping to the micro ejector, use a nylon or urethane tube with inner diameter of  $\phi 4 \sim \phi 6$  [ $\phi 0.157 \sim \phi 0.236$ in.]. For vacuum generation ports, tubes of the following sizes are recommended.  
ME03...  $\phi 4 \times 2.5$   
ME05...  $\phi 4 \times 2.5, \phi 6 \times 4$   
ME07...  $\phi 6 \times 4$

- Cautions:**
1. Use a fitting that does not reduce inner diameter. A small inner diameter can result in degradation of performance, including pressure shortages, insufficient vacuum, or longer periods of time before the vacuum level is reached.
  2. Avoid use of coil tubes and other curved piping. Also, avoid use of elbow fittings, etc., between the micro ejector and vacuum pad, and use piping that is as straight as possible.
  3. In manifolds with many units, where a large number of micro ejectors are operating simultaneously, or where the operation frequency is very high, supply air from P ports on both ends.



## Solenoid

### Internal circuit

#### ● DC12V, DC24 (surge suppression)

##### Standard solenoid

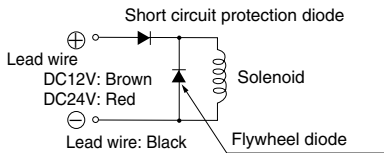

##### Solenoid with LED indicator

Order code: -PSL, -PLL

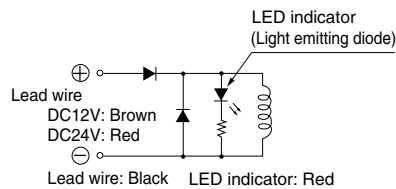

#### ● AC100V, AC200V (surge suppression)

##### Standard solenoid

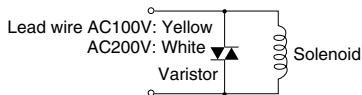

##### Solenoid with LED indicator

Order code: -PSL, -PLL

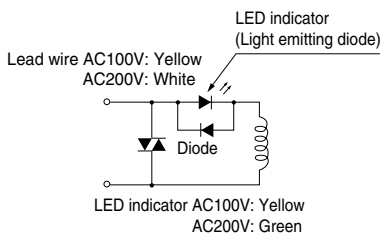

- Cautions:**
1. Do not apply megger between the lead wires.
  2. For DC12V, DC24V, while there is no danger with a solenoid of a short circuit by the wrong polarity, the valve will not operate.
  3. Leakage current inside the circuit could result in failure of the solenoid valve not to return to home position or other erratic operation. Always use within the range of the allowable leakage current. If circuit conditions, etc., cause the leakage current to exceed the maximum allowable leakage current, consult us.



## Plug connector

### Attaching and removing plug connector

Use fingers to insert the connector into the pin, push it in until the lever claw latches onto the protruded section on the connector housing, and complete the connection.

To remove the connector, squeeze the lever along with the connector, lift the lever claw up from the protruded section of the connector housing, and pull it out.

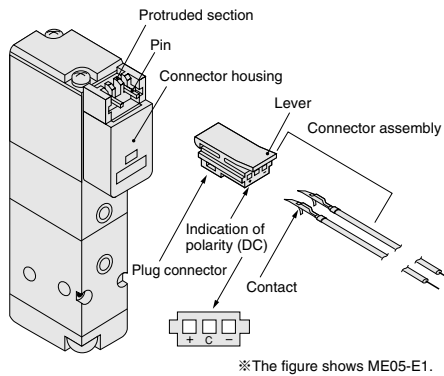

### Crimping of connecting lead wire and contact

To crimp lead wires into contacts, strip off 4mm [0.16in.] of the insulation from the end of the lead wire, insert it into the contact, and crimp it. Be sure to avoid catching the insulation on the exposed wire crimping section.

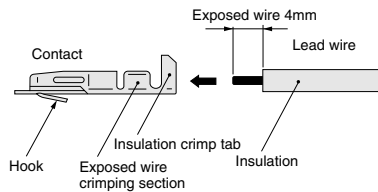

- Lead wire □ ME03 Equivalent to AWG 28  
 □ ME05  
 □ ME07 Equivalent to AWG 24

### Attaching and removing contact and connector

Insert the contact with a lead wire into a plug connector □ hole until the contact hook latches on the connector and is secured to the plug connector. Confirm that the lead wire cannot be easily pulled out.

To remove it, insert a tool with a fine tip (such as a small screwdriver) into the rectangular hole on the side of the plug connector to push up on the hook, and then pull out the lead wire.

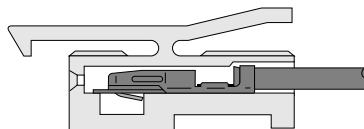

- Cautions:**
1. Do not pull hard on the lead wire. It could result in defective contacts, breaking wires, etc.
  2. If the pin is bent, use a small screwdriver, etc., to gently straighten out the pin, and then complete the connection to the plug connector.
  3. For crimping of connecting the lead wire and contact, always use a dedicated crimping tool.  
 Contact: Model 702062-2M  
 Manufactured by Sumiko Tech, Inc.  
 Crimping tool: Model F1-702062  
 Manufactured by Sumiko Tech, Inc.



## Manual override

### Non-locking type and locking protruding type

To operate non-locking type, use a tool with a thin tip (such as a small screwdriver) to press the manual override all the way down. The micro ejector works the same as an energized state as long as the manual override is pushed down, and returns to the reset position upon release.

To lock the locking protruding type manual override, use fingertips or a small screwdriver to push down on the manual override all the way and turn it 45 degrees or more. Either turning direction at this time is acceptable. When locked, turning the manual override from the locking position releases a spring on the manual override, returns it to its original position, and release the lock. If manual override is not turned, this type acts just like the non-locking type. The micro ejector works the same as an energized state as long as the manual override is pushed down, and returns to the reset position upon release.

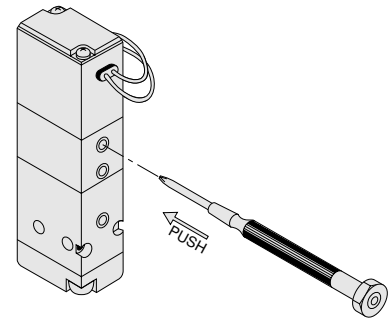

**Caution:** Always release the lock on the locking protruding type manual override before commencing normal operation.

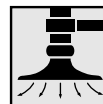

## Vacuum breaking

### Adjustment of vacuum breaking flow rate

Rotate the adjusting needle for vacuum breaking flow (with twin solenoid valves only) in the clockwise direction to reduce the breaking flow rate, and in the counterclockwise direction to increase the breaking flow rate.

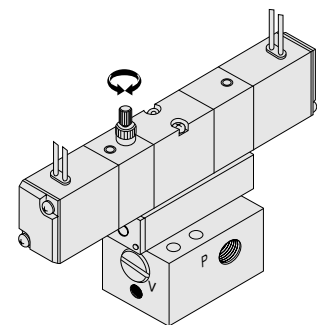

# Handling Instructions and Precautions



## Electronic Vacuum Switch

### Pressure regulation

Rotate the pressure adjusting screw (SET) to set the pressure. Rotating the pressure adjusting screw to the right (clockwise) increases the vacuum setting. In addition, use the hysteresis adjusting screw (HYS) to set the hysteresis. Rotating the hysteresis adjusting screw to the right (clockwise) increases the hysteresis by shifting the OFF position.

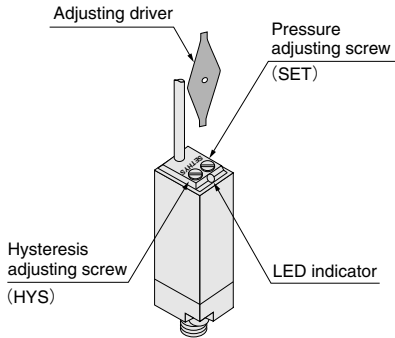

- Cautions:**
1. To set the pressure and hysteresis, use the special screwdriver provided or a small screwdriver of appropriate size, and adjust by rotating them carefully without applying excessive force.
  2. To ensure accurate pressure setting, use a pressure gauge to perform the setting while switching the vacuum switch on and off.
  3. Do not apply pressure to the pressure detection area of more than 0.2MPa [29psi].

### Wiring instructions

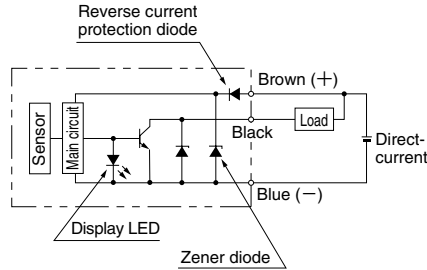

- Brown: Lead wire for connecting the (+) polarity that activates the switch
- Black: Lead wire for connecting the load
- Blue: Lead wire for connecting the (-) polarity

- Cautions:**
1. Do not subject the lead wires to strong pulling force or excessive bending.
  2. Pay attention to the lead wire colors to connect. While the lead wires between brown and blue, for connecting to the power supply, are protected by diodes for protection of reverse current, the output circuits do not have a surge current protection function. Miswiring could cause damage to the output transistor.
  3. Do not connect and use the vacuum switch with a load that exceeds its switching capacity.

### Mounting

1. As subjecting the vacuum switch to strong shocks could lead to damage or erratic operation, be careful when handling it.
2. Do not apply a wrench to the body cover when mounting as a single unit (PS310E-01). When tightening, always apply the wrench to the metal part of the adapter.

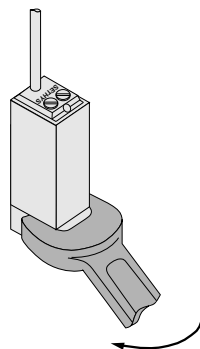

## General precautions

1. If using in locations subject to dripping water, dripping oil, etc., or to large amounts of dust, use a cover to protect the unit.
2. Always thoroughly blow off (use compressed air) the piping before connecting it to the micro ejector. Intrusion into the piping of chips, sealing tape, rust, or other foreign material generated during piping operations could result in valve air leaks or a degradation in micro ejector performance.
3. Use clean air that does not contain deteriorated compressor oil or other contaminants. Install an air filter (with filtration of a minimum 40 μm) close to the micro ejector to eliminate any collected liquids or dust in air line. Always use a mist filter for cases where the pressurized air contains large amounts of oils. Moreover, drain the air filter at regular intervals.
4. Use a regulator to adjust the pressure of air supplied to the micro ejector. Where the piping length to the micro ejector is long, set the pressure at a little higher than normal. If using an air supply valve, use a valve with an effective area that is at least three times as large as the area of the micro ejector nozzle.
5. Use one vacuum pad for one micro ejector. Use of two or more pads could result in picking errors, and extend the amount of time required to reach the set vacuum level.
6. At periodic intervals, replace the filters (order code: ME□ MA-F) installed as standard equipment with the micro ejector body.