

KOGANEI

ACCESSORIES GENERAL CATALOG

AIR TREATMENT, AUXILIARY, VACUUM,
AND FLUORORESIN PRODUCTS

SUPPLY JOINTS CONTENTS



Specifications, Order Codes, Size Table	371
Dimensions	373
NCU Specification Order Codes, Model Table	379
Safety Precautions, Handling Instructions and Precautions	380

SUPPLY JOINTS

 **Caution** Before use, be sure to read the “Safety Precautions” on p. 49.

SUPPLY JOINTS

- Use just half of the piping space of a steel pipe with the same inner diameter and flow rate.
- 44 types and 83 models offer a wide selection of combinations.
- Highly rust-resistant nickel plated is standard specifications.

Specifications

Media	Air
Maximum operating pressure	0.9MPa [131psi.]
Operating vacuum pressure	-100kPa [-29.54in.Hg]
Operating temperature range	0~60°C [32~140°F]
Recommended tube	Nylon tube, urethane tube
Sales unit	1 pc.

Order Codes

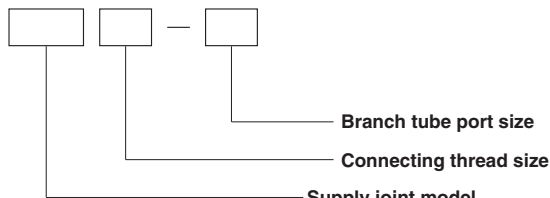

※For the connection methods, the tube size, and thread size combinations, see p. 371~372.
Remark: For the NCU specification, see p.379.

Inner Construction, Major Parts and Materials

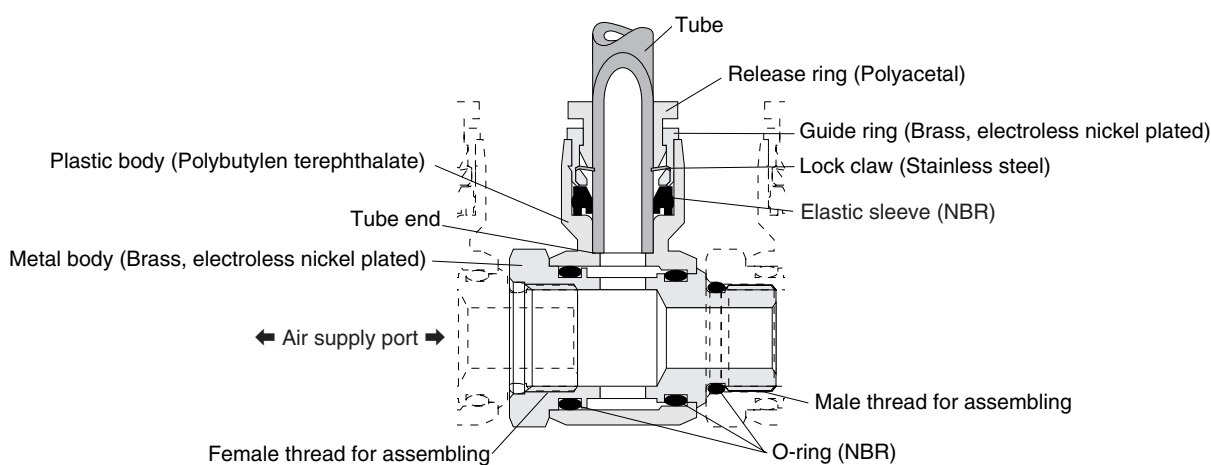

●STQ Terminal quick 373



Main side thread size	Sub-main side tube size					
	4	6	8	10	12	16
M8X1 (8)	8-4	8-6	—	—	—	—
M12X1 (12)	—	12-6	12-8	—	—	—
M14X1 (14)	—	—	14-8	14-10	14-12	—
M18X1 (18)	—	—	—	—	18-12	18-16

●STB Terminal branch 373



Main side thread size	Sub-main side tube size	
	10	12
M14X1 (14)	14-10	—
M18X1 (18)	—	18-12

●STS Terminal straight 374



Main side thread size	Sub-main side thread size			
	M8X1	M12X1	M14X1	M18X1
M12X1 (12)	12-8	12-12	—	—
M14X1 (14)	—	12-14	14-14	—
M18X1 (18)	—	—	18-14	18-18

●STT Terminal taper 374



Main side thread size	Sub-main side thread size				
	M5X0.8	M6X1	Rc1/8	Rc1/4	Rc3/8
M8X1 (8)	8-M5	8-M6	8-01	—	—
M12X1 (12)	—	12-M6	12-01	—	—
M14X1 (14)	—	—	14-01	14-02	—
M18X1 (18)	—	—	—	18-02	18-03

●SBA Bushing A 375



Main side thread size	Sub-main side thread size (R)			
	1/8	1/4	3/8	1/2
M8X1 (8)	8-01	—	—	—
M12X1 (12)	12-01	12-02	12-03	—
M14X1 (14)	—	14-02	14-03	14-04
M18X1 (18)	—	—	18-03	18-04

●SBB Bushing B 375



Main side thread size	Sub-main side thread size		
	M8X1	M12X1	M14X1
M12X1 (12)	12-8	—	—
M14X1 (14)	—	14-12	—
M18X1 (18)	—	—	18-14

●SBC Bushing C 375



Main side thread size	Sub-main side thread size			
	M5	M6	Rc1/8	Rc1/4
M8X1 (8)	8-M5	—	—	—
M12X1 (12)	—	12-M6	—	—
M14X1 (14)	—	—	14-01	—
M18X1 (18)	—	—	—	18-02

●SLB Elbow 376



Main side thread size	Sub-main side thread size (R)			
	1/8	1/4	3/8	1/2
M8X1 (8)	8-01	—	—	—
M12X1 (12)	12-01	12-02	—	—
M14X1 (14)	—	14-02	14-03	14-04
M18X1 (18)	—	—	18-03	18-04

●SST Socket 376



Main side thread size	Sub-main side thread size (Rc)			
	1/8	1/4	3/8	1/2
M8X1 (8)	8-01	—	—	—
M12X1 (12)	—	12-02	—	—
M14X1 (14)	—	—	14-03	—
M18X1 (18)	—	—	—	18-04

●SKR Reducer for bulkhead 376



Main side thread size	Sub-main side tube size				
	4	6	8	10	12
M8X1 (8)	8-4	8-6	—	—	—
M12X1 (12)	—	12-6	12-8	12-10	—
M14X1 (14)	—	—	14-8	14-10	14-12
M18X1 (18)	—	—	—	—	18-12

●SPG Plug 377



Thread size	
M8X1	8
M12X1	12
M14X1	14
M18X1	18

●SCP Cap 377



Thread size	
M8X1	8
M12X1	12
M14X1	14
M18X1	18

●SBN Nipple 377



Thread size	
M8X1	8-8
M12X1	12-12
M14X1	14-14
M18X1	18-18

●SZB Bracket 378



Model	Mounting model
6	SPG, SCP
12	SKR8-4
14	SKR□-6
16	SKR□-8
20	SKR□-10
22	SKR□-12
61	SPG, SCP
62	SPG, SCP

●SZS Wrench for assembling



Size	
Width across flats	Thickness
10X12	3.4
14X17	
19X22	4
24X27	

●Thin wrenches, specially designed for the supply joints.

●Sales unit : one set

Dimensions (mm)

Terminal quick STQ



Model	Tube outer diameter ϕ D	M	A1	A2	B	L1	L2	ϕ P1	ϕ P2	C	E	H	Effective area (mm ²)	Mass (g) [oz.]
STQ8-4	4	M8X1	6.5	7.5	25.7	8.2	19.2	10	15.4	14.9	22.2	14	4.7	16 [0.56]
STQ8-6	6							12.5		17	24.2		7	17 [0.60]
STQ12-6	6	M12X1	7	7.5	27.2	8.7	20.2	12.5	19.6	17	26.8	17	8.7	23 [0.81]
STQ12-8	8							14.5		18.1	28.2		11	25 [0.88]
STQ14-8	8	M14X1	8	8.5	31.2	10.2	23.2	14.5	24.4	18.1	30.2	22	16.7	39 [1.38]
STQ14-10	10							18		20.2	32.5		19.5	42 [1.48]
STQ14-12	12							11.7		21	23.4		35.2	21.1
STQ18-12	12	M18X1	8	8.5	35.2	11.7	27.2	21	30	23.4	38.2	24	40.4	61 [2.15]
STQ18-16	16			8	41.1	14.6	33.1	25	28	23.6	36.6	27	50.4	71 [2.50]

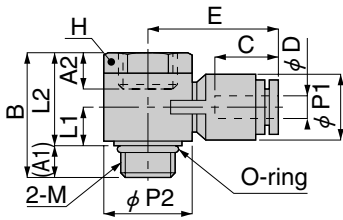

Terminal branch STB



Model	Tube outer diameter ϕ D	M	B	L1	L2	ϕ P1	ϕ P2	C	E	J	F	H	Effective area (mm ²)	Mass (g) [oz.]
STB14-10	10	M14X1	31.2	10.2	23.2	17.6	23	20.7	33.5	17	15	22	17.8	49 [1.73]
STB18-12	12	M18X1	35.2	11.7	27.2	21	27	23.4	37.4	20	17	24	35.6	70 [2.47]

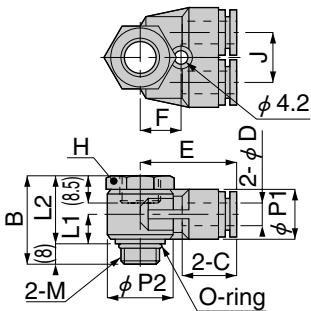

Dimensions (mm)

Terminal straight STS



Model	M1	M2	A1	A2	A3	B	L1	L2	φ P1	φ P2	E	H1	H2	Effective area (mm ²)	Mass (g) [oz.]
STS12-8	M12X1	M8X1	7	7.5	7	27.2	8.7	20.2	12.5	19.6	26	17	12	8.4	26 [0.92]
STS12-12		M12X1			7.5		10.2		18		29.5		17	12.9	35 [1.23]
STS14-12	M14X1	M12X1	8	8.5	7.5	31.2	10.2	23.2	18	24.4	31.5	22	17	20.8	49 [1.73]
STS14-14		M14X1			8.5		11.7		21		34		19	20.6	55 [1.94]
STS18-14	M18X1	M14X1	5	8.5	8.5	35.2	11.7	27.2	21	30	37	24	19	40.1	71 [2.50]
STS18-18		M18X1		8			41.1		14.6		33.1		25	28	35.5

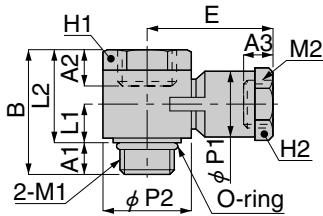

Terminal taper STT



Model	Rc	M	A1	A2	A3	B	L1	L2	φ P1	φ P2	E	H1	H2	Effective area (mm ²)	Mass (g) [oz.]
STT8-M5	M5X0.8	M8X1	6.5	7.5	6	25.7	8.2	19.2	12.5	15.4	23.4	14	12	7.3	22 [0.78]
STT8-M6	M6X1				8				14.5		25.5		14	7.8	23 [0.81]
STT8-01	Rc1/8				14.5				25.5		14		7.8	23 [0.81]	
STT12-M6	M6X1	M12X1	7	7.5	6	27.2	8.7	20.2	12.5	19.6	26	17	12	9.7	28 [0.99]
STT12-01	Rc1/8				8				14.5		27.5		14	12.4	29 [1.02]
STT14-01	Rc1/8	M14X1	8	8.5	8	31.2	10.2	23.2	14.5	24.4	29.5	22	14	16.1	44 [1.55]
STT14-02	Rc1/4				11				21		34		19	21.4	59 [2.08]
STT18-02	Rc1/4	M18X1	8	8.5	11	35.2	11.7	27.2	21	30	37	24	19	36.9	75 [2.65]
STT18-03	Rc3/8			8									12	41.1	14.6

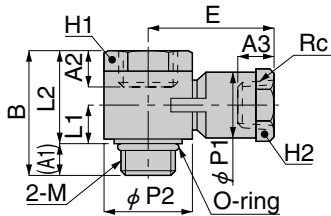

Dimensions (mm)

Bushing A SBA

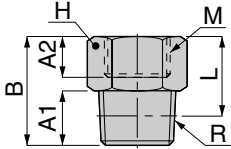

Model	R	M	A1	A2	B	L ^{Note}	H	Effective area (mm ²)	Mass (g) [oz.]
SBA8-01	R1/8	M8×1	8	8	20	16	12	24.5	11 [0.39]
SBA12-01	R1/8	M12×1	8	8.5	20	16	17	24.7	18 [0.64]
SBA12-02	R1/4		11		23	17		42.3	20 [0.71]
SBA12-03	R3/8		12		24	17.7		27 [0.95]	
SBA14-02	R1/4	M14×1	11	8.5	23	17	19	42.7	23 [0.81]
SBA14-03	R3/8		12		24	17.7		25 [0.88]	
SBA14-04	R1/2		13		25	16.8		22	56.1
SBA18-03	R3/8	M18×1	12	8.5	25	18.7	22	56.1	29 [1.02]
SBA18-04	R1/2		13			16.8			24

Note: The L dimensions are the reference dimensions after the fittings are assembled.

Bushing B SBB

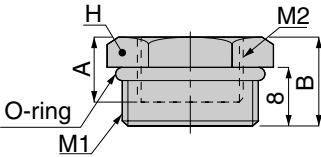

Model	M1	M2	A	B	H	Mass (g) [oz.]
SBB12-8	M12×1	M8×1	8	12	14	7.4 [0.261]
SBB14-12	M14×1	M12×1	7.5	20	17	21 [0.74]
SBB18-14	M18×1	M14×1	12	12	19	11 [0.39]

Bushing C SBC

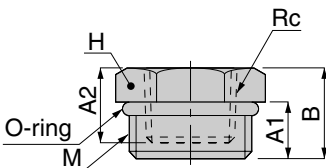

Model	Rc	M	A1	A2	B	H	Mass (g) [oz.]
SBC8-M5	M5×0.8	M8×1	7	5	11	10	3.8 [0.134]
SBC12-M6	M6×1	M12×1	7.5	6	11.5	14	9.6 [0.339]
SBC14-01	Rc1/8	M14×1	8	8	12	17	12 [0.42]
SBC18-02	Rc1/4	M18×1	8	11	13	19	17 [0.60]

Dimensions (mm)

Elbow SLB

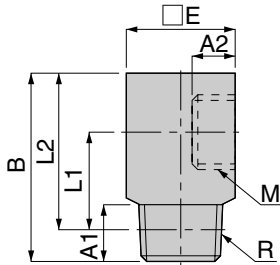

Model	R	M	A1	A2	B	Note L1	Note L2	E	Effective area (mm ²)	Mass (g) [oz.]
SLB8-01	R1/8	M8×1	8	7	28	16	24	17	21.4	42 [1.48]
SLB12-01	R1/8	M12×1	8	8.5	29	15	25	19	24.5	48 [1.69]
SLB12-02	R1/4		11		32	16	26		40	50 [1.76]
SLB14-02	R1/4	M14×1	11	8.5	37	19	31	22	42.7	80 [2.82]
SLB14-03	R3/8		12		38	19.7	31.7		46	82 [2.89]
SLB14-04	R1/2		13		39	18.8	30.8		93 [3.28]	
SLB18-03	R3/8	M18×1	12	9	44	23.7	37.7	27	49	141 [4.97]
SLB18-04	R1/2		13		45	22.8	36.8		157 [5.54]	

Note: The L1 and L2 dimensions are the reference dimensions after the fittings are assembled.

Socket SST

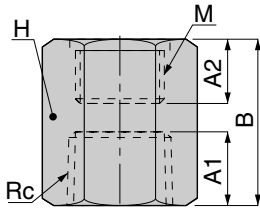

Model	Rc	M	A1	A2	B	H	Mass (g) [oz.]
SST8-01	Rc1/8	M8×1	8	9	20	12	12 [0.42]
SST12-02	Rc1/4	M12×1	11	9	24	17	29 [1.02]
SST14-03	Rc3/8	M14×1	12	10	27	22	57 [2.01]
SST18-04	Rc1/2	M18×1	15	10	28	27	84 [2.96]

Reducer for bulkhead SKR

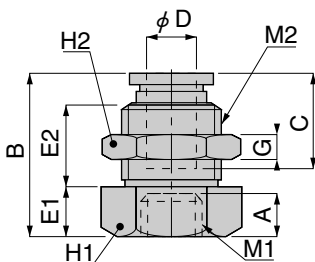

Model	Tube outer diameter φ D	M1	M2	A	B	E1	E2	C	G	H1	H2	Effective area (mm ²)	Mass (g) [oz.]	
SKR8-4	4	M8×1	M12×1	8.5	26	8	13.4	14.9	4	14	14	5.6	19 [0.67]	
SKR8-6	6		M14×1		28.1		17	17		11.5	29 [1.02]			
SKR12-6	6	M12×1	M14×1	8.5	28.1	12	10.9	17	4	17	17	13.2	28 [0.99]	
SKR12-8	8		M16×1		28.9	10	13.4	18.2		5	22	24	34.8	60 [2.12]
SKR12-10	10		M20×1		32.3	16.4	20.7	5		22	24	34.8	60 [2.12]	
SKR14-8	8	M14×1	M16×1	8.5	28.9	12	11.4	18.2	4	19	19	27.7	33 [1.16]	
SKR14-10	10		M20×1		32.3	10	16.4	20.7		5	24	24	41.7	64 [2.26]
SKR14-12	12		M22×1		34.9	12	17.4	23.3		6	27	27	54.7	78 [2.75]
SKR18-12	12		M18×1		M22×1	8.5	34.9	12		17.4	23.3	6	27	27

Dimensions (mm)

Plug SPG



Model	M	A1	A2	B	H	Mass (g) [oz.]
SPG8	M8×1	6	5	14	12	9 [0.317]
SPG12	M12×1	6	5	9	14	7.9 [0.279]
SPG14	M14×1	6	5	10	17	14 [0.49]
SPG18	M18×1	7	6	12	19	25 [0.88]

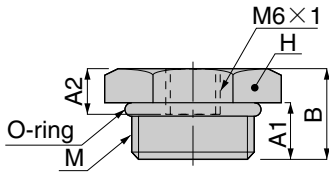

Cap SCP



Model	M	A	B	H	Mass (g) [oz.]
SCP8	M8×1	6.5	20	12	17 [0.60]
SCP12	M12×1	7	22	14	22 [0.78]
SCP14	M14×1	8	23	17	34 [1.20]
SCP18	M18×1	8	25	22	64 [2.26]

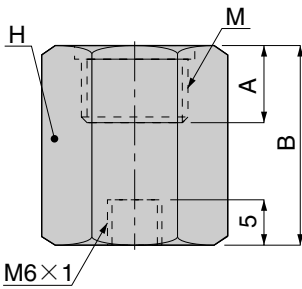

Nipple SBN



Model	M	A	B	H	Mass (g) [oz.]
SBN8-8	M8×1	7	18	10	5.6 [0.198]
SBN12-12	M12×1	8	20	14	13 [0.46]
SBN14-14	M14×1	8	20	17	16 [0.56]
SBN18-18	M18×1	8	20	19	19 [0.67]

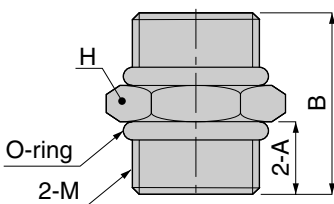

Dimensions (mm)

Bracket SZB

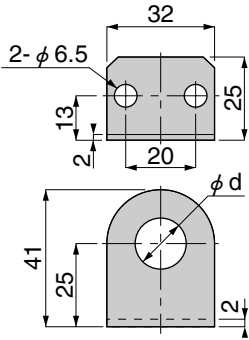

Model	ϕ d	Mass (g) [oz.]	Mounting model
SZB6	7	28 [0.99]	SPG, SCP
SZB12	13	26 [0.92]	SKR8-4
SZB14	15	26 [0.92]	SKR8-6, SKR12-6
SZB16	17	25 [0.88]	SKR12-8, SKR14-8
SZB20	21	23 [0.81]	SKR12-10, SKR14-10, SKR18-10
SZB22	23	22 [0.78]	SKR14-12, SKR18-12

Bracket SZB61, 62

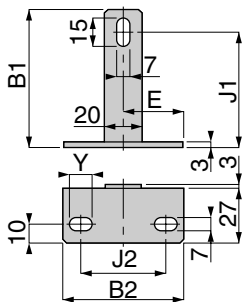

Model	B1	B2	J1	E	J2	Y	Mass (g) [oz.]	Mounting model
SZB61	75	65	62.5	32.5	46	12	73 [2.57]	SPG, SCP
SZB62		80		40	63	13	84 [2.96]	

SUPPLY JOINTS

NCU Specification

- For specifications, see p.371.
- The dimensions for **NCU** specification shown below are the same as the standard type. See the dimensions on p.373~378.
The sealant is not applied to the R taper thread portion of the **NCU** specification fittings.

Caution: For delivery, consult us.

NCU Specification

● Order codes

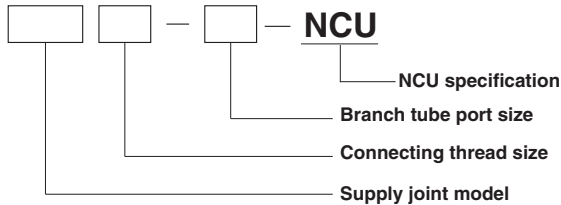

※ For the fitting models, the tube size and thread combinations, see the table below. Columns showing the “←” symbol indicate that standard products can be used as the NCU specification. In these cases, place orders for the standard products.

● Model Table (NCU Specification)

Type	Tube outer diameter	Thread	Standard type model (reference)	NCU specification model
Terminal quick STQ	4	M8×1	STQ8-4	←
	6	M8×1	STQ8-6	←
	6	M12×1	STQ12-6	←
	8	M12×1	STQ12-8	←
	8	M14×1	STQ14-8	←
	10	M14×1	STQ14-10	←
	12	M14×1	STQ14-12	←
	12	M18×1	STQ18-12	←
Terminal branch STB	10	M14×1	STB14-10	←
	12	M18×1	STB18-12	←
Terminal straight STS	—	M12×1, M8×1	STS12-8	←
	—	M12×1	STS12-12	←
	—	M14×1, M12×1	STS14-12	←
	—	M14×1	STS14-14	←
	—	M18×1, M14×1	STS18-14	←
Terminal taper STT	—	M18×1	STS18-18	←
	—	M8×1, M5×0.8	STT8-M5	←
	—	M8×1, M6×1	STT8-M6	←
	—	M8×1, Rc1/8	STT8-01	←
	—	M12×1, M6×1	STT12-M6	←
	—	M12×1, Rc1/8	STT12-01	←
	—	M14×1, Rc1/8	STT14-01	←
	—	M14×1, Rc1/4	STT14-02	←
Bushing A SBA	—	M18×1, Rc1/4	STT18-02	←
	—	M18×1, Rc3/8	STT18-03	←
	—	M8×1, R1/8	SBA8-01	SBA8-01-NCU
	—	M12×1, R1/8	SBA12-01	SBA12-01-NCU
	—	M12×1, R1/4	SBA12-02	SBA12-02-NCU
	—	M12×1, R3/8	SBA12-03	SBA12-03-NCU
	—	M14×1, R1/4	SBA14-02	SBA14-02-NCU
	—	M14×1, R3/8	SBA14-03	SBA14-03-NCU
	—	M14×1, R1/2	SBA14-04	SBA14-04-NCU
	—	M18×1, R3/8	SBA18-03	SBA18-03-NCU
Bushing B SBB	—	M18×1, R1/2	SBA18-04	SBA18-04-NCU
	—	M12×1, M8×1	SBB12-8	←
	—	M14×1, M12×1	SBB14-12	←
Bushing C SBC	—	M18×1, M14×1	SBB18-14	←
	—	M8×1, M5×0.8	SBC8-M5	←
	—	M12×1, M6×1	SBC12-M6	←
	—	M14×1, Rc1/8	SBC14-01	←
	—	M18×1, Rc1/4	SBC18-02	←
	—	M18×1, Rc1/4	SBC18-02	←
Elbow SLB	—	M8×1, R1/8	SLB8-01	SLB8-01-NCU
	—	M12×1, R1/8	SLB12-01	SLB12-01-NCU
	—	M12×1, R1/4	SLB12-02	SLB12-02-NCU
	—	M14×1, R1/4	SLB14-02	SLB14-02-NCU
	—	M14×1, R3/8	SLB14-03	SLB14-03-NCU
	—	M14×1, R1/2	SLB14-04	SLB14-04-NCU
	—	M18×1, R3/8	SLB18-03	SLB18-03-NCU
	—	M18×1, R1/2	SLB18-04	SLB18-04-NCU
Socket SST	—	M8×1, Rc1/8	SST8-01	←
	—	M12×1, Rc1/4	SST12-02	←
	—	M14×1, Rc3/8	SST14-03	←
Reducer for bulkhead SKR	—	M18×1, Rc1/2	SST18-04	←
	4	M8×1	SKR8-4	←
	6	M8×1	SKR8-6	←
	6	M12×1	SKR12-6	←
	8	M12×1	SKR12-8	←
	10	M12×1	SKR12-10	←
	8	M14×1	SKR14-8	←
	10	M14×1	SKR14-10	←
Plug SPG	12	M14×1	SKR14-12	←
	12	M18×1	SKR18-12	←
	—	M8×1	SPG8	←
	—	M12×1	SPG12	←
	—	M14×1	SPG14	←
	—	M18×1	SPG18	←
Cap SCP	—	M8×1	SCP8	←
	—	M12×1	SCP12	←
	—	M14×1	SCP14	←
Nipple SBN	—	M18×1	SCP18	←
	—	M8×1	SBN8-8	←
	—	M12×1	SBN12-12	←
	—	M14×1	SBN14-14	←
Bracket SZB	—	M18×1	SBN18-18	←
	—	—	SZB6	←
	—	—	SZB12	←
	—	—	SZB14	←
	—	—	SZB16	←
	—	—	SZB20	←
	—	—	SZB22	←
	—	—	SZB61	←
—	—	SZB62	←	

Safety Precautions (Supply Joints)

The following is a safety precaution to Supply Joints. For other safety precautions, be sure to read the precautions on p.49.

Warning

- With the exception of the Quick Fittings Rotary Type, do not use any quick fittings in locations where thread portions or tubes are subject to swing or rotations. The swing or rotations could result in damage to the fitting body.
- Use brackets or other support fixtures when subjecting the supply joint to bending loads or connecting supply joints in large numbers. Failure to use such supports could result in deformation of units attached to the supply joint or in damage to the fitting body.

Handling Instructions and Precautions

● Mounting

Precautions for mounting the body

1. To mount the body, use a suitable tool to tighten it to the outer or inner hexagonal section of the fitting.
2. When tightening screws, tighten to the recommended tightening torque shown in the table below. Tightening to more than the recommended torque could result in broken threads or air leaks due to deformed gaskets. Tightening to less than the recommended torque could lead to loose screws or air leaks.
3. For fittings with fixed piping direction, tighten to the desired piping direction, and then adjust so that it falls within the range of the body tightening torque.

Recommended tightening torque, sealant color, and gasket material

Thread type	Thread size	Tightening torque	Sealant color	Gasket material
Metric thread	M3×0.5	0.7N·m [6.2in·lbf]	—	SUS304 NBR
	M5×0.8	1.0~1.5N·m [8.9~13.3in·lbf]		
	M6×1	1.8~2.3N·m [15.9~20.4in·lbf]		
	M8×1	5.98N·m [52.9in·lbf]		Synthetic rubber (NBR)
	M12×1	21.1N·m [187in·lbf]		
	M14×1	34.3N·m [304in·lbf]		
Taper pipe thread	M18×1	74.5N·m [659in·lbf]	White	—
	R1/8	7~9N·m [62~80in·lbf]		
	R1/4	12~14N·m [106~124in·lbf]		
	R3/8	22~24N·m [195~212in·lbf]		
	R1/2	28~30N·m [248~266in·lbf]		

Caution

- For mounting or removing the Supply Joints, use the wrench provided for main block assembly. Without using this wrench could prevent easy assembly, or result in deformation of the main body.

Precautions for disconnecting the body

1. To disconnect the body, use a suitable tool to loosen it from the outer or inner hexagonal section of the body.
2. Clean off the sealant coating on the thread of the removed mating part. The coated sealant could enter other relating parts, and cause breakdowns.

Method for tightening threads

For tightening threads, use a wrench on outer hexagonal section.

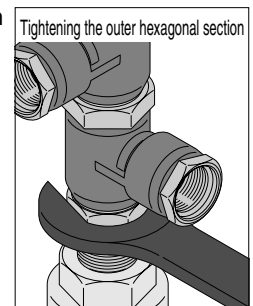

Caution: While the quick fitting sealant can be reused a number of times, the thread on the mating part may also be adhered with sealant. Always clean out the inside of the equipment's female thread.

● Tube connection and disconnection

Precautions for connecting the tube

1. Check that the cut section of the tube has been cut at straight angle, that the outer surface of the tube is not scratched, and that the tube has not become oval shaped.
2. When connecting a tube, failure to insert the tube all the way to the end could result in air leaks.

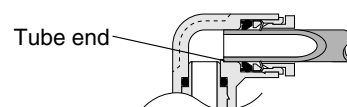

3. After connection, pull the tube to check that it will not disconnect.

Precautions for disconnecting the tube

1. Before disconnecting a tube, check that the pressure inside the tube is down to zero.
2. Push the release ring evenly all the way to the end, and then pull the tube out. An insufficient push could make it impossible to pull the tube out, or could scratch the tube, leaving scratched tube material inside the fitting.

Handling Instructions and Precautions

Tube connection and disconnection method

1. Tube connection

The fitting type in the main block (quick fittings) is equipped with a lock claw that holds the tube in place when it has been pushed all the way to the end, and with an elastic sleeve for sealing the tube periphery.

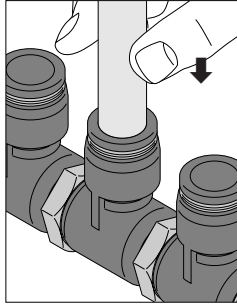

2. Tube disconnection

To disconnect the tube, first push on the release ring, releasing the lock claw, and then pull the tube out.

Always stop the air supply before removing the tube.

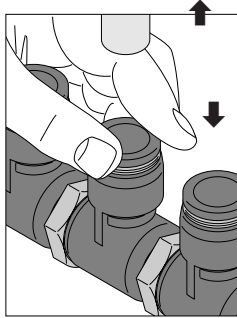

For cases where tight or cramped piping spaces hinder tube removal operations, a special tool is available. Consult us for details.

Special tool for tube removal

For ϕ 3 [0.118in.], ϕ 4 [0.157in.] and ϕ 6 [0.236in.] tubes
Order code : **UJ-1**



For ϕ 6 [0.236in.], ϕ 8 [0.315in.],
 ϕ 10 [0.394in.] and ϕ 12 [0.472in.] tubes
Order code : **UJ-2**



● Usable tubes

Either nylon or urethane tubes can be used. The tube outer diameter accuracy should be, for nylon tubes, within $\pm 0.1\text{mm}$ [$\pm 0.004\text{in.}$] of the nominal dimensions, and for urethane tubes, within $\pm 0.15\text{mm}$ [$\pm 0.006\text{in.}$] of the nominal dimensions, while the ovalness (difference between long diameter and short diameter) should be within 0.2 mm [0.008in.].

- Cautions:**
1. Use tubes with no visible scratches on the outer surface. If a scratch is made during repeated use, cut off the scratched portion.
 2. Do not bend or twist the tube too much near the connection to the fitting. It could result in air leaks. The minimum bending radius for nylon tubes is as shown in the table below.

mm [in.]

Tube size	Minimum bending radius
ϕ 4 [0.157]	20 [0.8]
ϕ 6 [0.236]	30 [1.2]
ϕ 8 [0.315]	50 [2.0]
ϕ 10 [0.394]	80 [3.2]
ϕ 12 [0.472]	150 [5.9]
ϕ 16 [0.630]	500 [20]

Mounting Method

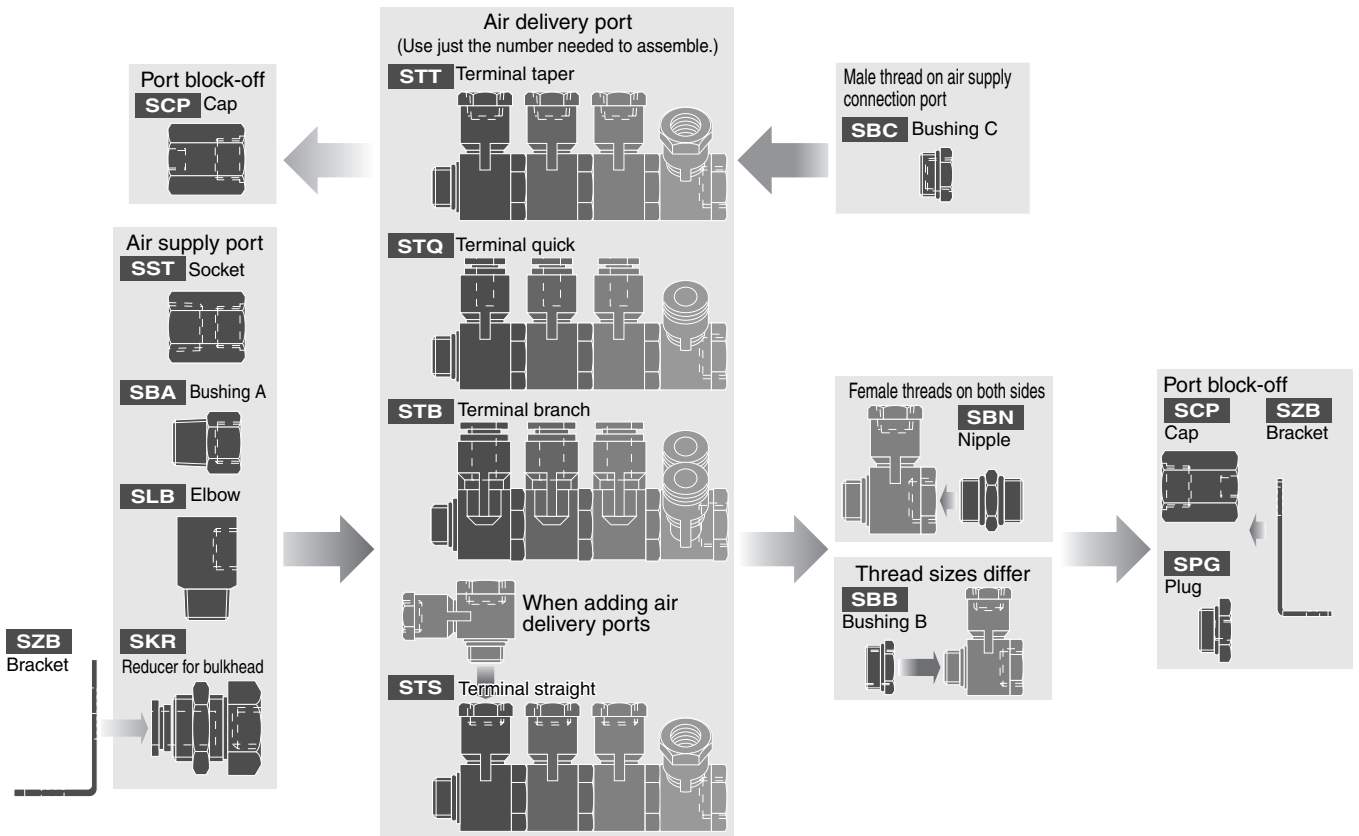

SUPPLY JOINTS

- The S in S□□ code shown in the diagram above refers to a metric thread, and if they are the same size, threads can be mated and assembled.
 - Air delivery port (3 types) Terminal quick (STQ), Terminal branch (STB), Terminal taper (STT) (Use just the number needed to assemble.)
 - Air supply port (5 types) Bushing A (SBA), Elbow (SLB), Bushing C (SBC), Socket (SST), Reducer for bulkhead (SKR)
 - Block-off (2 types) Plug (SPG), Cap (SCP)
 - Different assembly thread sizes Bushing B (SBB)
 - Female threads on both assembly thread sides Nipple (SBN)
 - Mounting bracket Bracket (SZB)

Piping Example

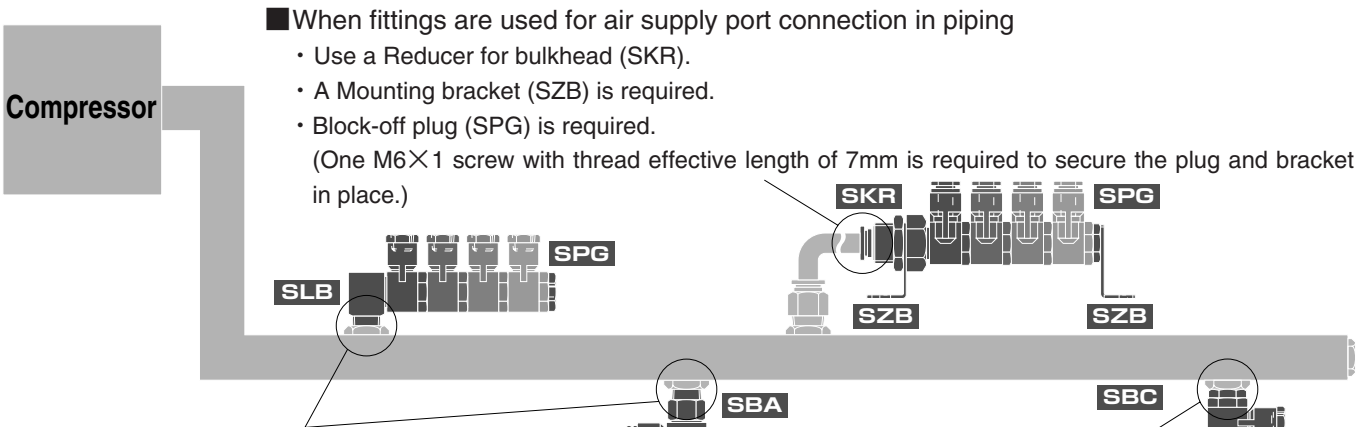

- When female thread type are used for air supply port connection in piping
 - Use Elbow (SLB) or Bushing A (SBA).
 - Block-off plug (SPG) is required.

- When male thread type are used for air supply port connection in piping
 - Use Bushing C (SBC).
 - Block-off cap (SCP) is required.