

Jig Cylinders with Guides

$\phi 6$, $\phi 8$ and $\phi 10$ mm bore

More compact than ever

Comparison of current $\phi 12$ mm with new $\phi 6, 8, 10$ mm bore sizes.

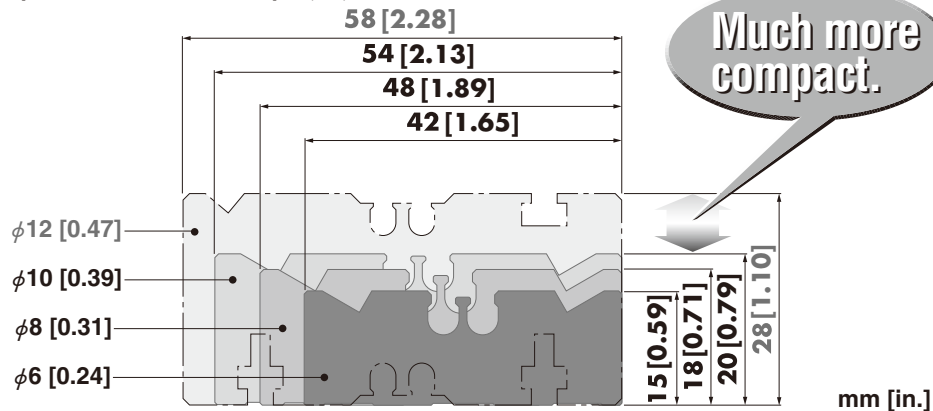

Select guide rod bearing by application

1. Slide bearing type

Suitable for applications with lateral impact side loads, e.g., for use as a stopper due to improved wear resistance.

2. Rolling bearing type

Suitable for use as a pusher or lifter due to smooth and high-precision operation.

Stroke adjusting cylinder

The stroke adjusting rod can be used to adjust the push-side stroke range from 0 to -5mm [-0.20in.].

Three different piping locations are available

You can select the best piping location for your installation requirement, enabling logical design layout.

(Please select the piping direction required when ordering.)

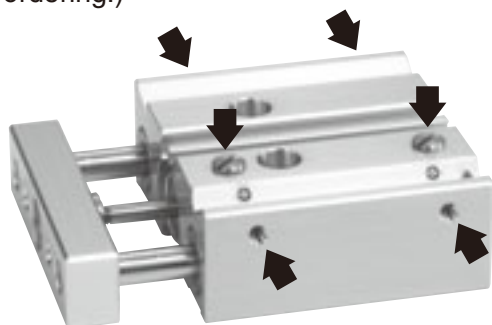

Photo shows -R specification.

A magnet is included as standard for new ZE solid-state sensor switch application

Low speed cylinder

- Stable operation from 5mm/s [0.20in./sec.]
- Smooth operation with reduced stick or slip adhesion
- Ideal for carrying fragile workpieces at low speed

Three mounting types are available

● Top mounting

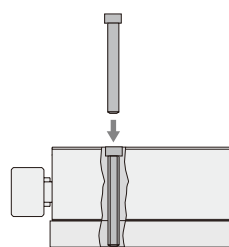

● Head mounting

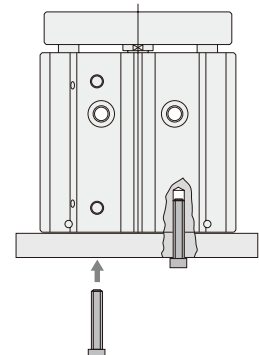

● Bottom mounting

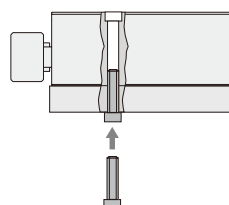



JIG CYLINDERS WITH GUIDES $\phi 6$, $\phi 8$, $\phi 10$



Caution

If you handle the grease used in the assembly of the low speed cylinders, be sure to carefully wash your hands afterwards. If you smoke a cigarette without first washing your hands, the grease may adhere to the cigarette and produce toxic gas by burning. (While the grease used in the low speed cylinder is chemically stable at room temperature, it will produce toxic gas when heated to more than 250°C [482°F].)

Standard Cylinders



Low Speed Cylinders



Stroke Adjusting Cylinders



Sensor Switches



Application Example

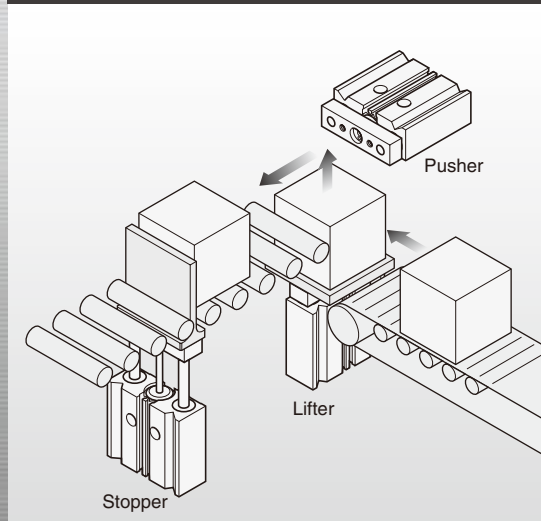

Handling Instructions and Precautions



General precautions

Allowable kinetic energy

When carrying an inertial load, always operate the cylinder at a kinetic energy at the allowable value or below.

For the relation between load and piston speed, see “Allowable Load Range” on p.688.

Piping

1. Always thoroughly blow off (use compressed air) the piping before connecting it to the Jig Cylinder with Guide. Entering chips, sealing tape, rust, etc., generated during piping work could result in air leaks or other defective operation.
2. When screwing piping or fittings into the Jig Cylinder with Guide, secure to the tightening torque shown below.

Connecting screw	Tightening torque N·m [in·lbf]
M3×0.5	0.59 [5.22]

3. See the diagram below for piping to low speed cylinders.

Recommended circuit

① Basic circuit

Use a meter-out speed controller.

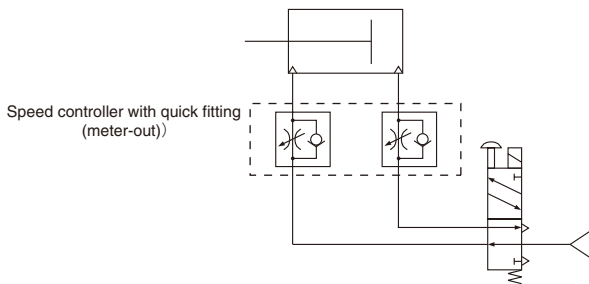

② Popping out prevention circuit

As shown in the diagram below, a circuit with combined speed controllers is good for speed control and also for prevention of popping out.

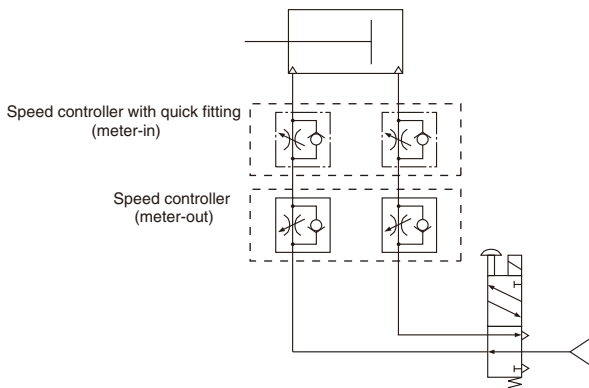

Note: Position the cylinder and speed controller as close together as possible.

Handling Instructions and Precautions

Media

1. Use air for the media. For the use of any other media, consult us.
2. Air used for the cylinder should be clean air that contains no deteriorated compressor oil, etc. Install an air filter (filtration of a minimum 40 μm) near the cylinder or valve to remove collected liquid or dust. In addition, drain the air filter periodically. Collected liquid or dust entering the cylinder may cause improper operation.

Lubrication

Do not lubricate the low speed cylinder. Lubrication could lead to defective operation.

While the standard cylinder and stroke adjusting cylinder can be used without lubrication, use Turbine Oil Class 1 (ISO VG32) or equivalent, if required. Avoid using spindle oil or machine oil.

Atmosphere

If using in locations subject to dripping water, dripping oil, etc., use a cover to protect the unit.

Environment

1. If using in locations subject to dripping water, dripping oil, etc., or to large amounts of dust, use a cover to protect the unit.
2. Do not use the cylinder in ambient atmospheres that could result in corrosion. Application in this kind of environment may result in damage or in improper operation.
3. Do not use in extremely dry conditions.
4. The most desirable temperature range for cylinders is 5~60°C [41~140°F]. Do not use in condition where temperatures exceed 60°C [140°F], as it could result in damage or in improper operation. In addition, since the water content at temperatures below 5°C [41°F] could freeze, resulting in damage or in improper operation, use caution to prevent freezing.

When in use

1. Do not place hands, etc., in the cylinder's operating range.
2. Pay full attention to the cylinder's operating direction during set up.
3. Take care to avoid trapping body or fingers between the cylinder body and the end plate when the cylinder retracts.
4. Confirm that no residual pressure remains inside the cylinder before commencing maintenance.
5. In its application as a stopper, it is assumed that the conveyed items will be cardboard boxes, plastic cases, etc. In cases where steel and other metal blocks are carried, select a sufficiently margined safer product or use a shock absorber with sufficient capacity.
6. Use the cylinder at speed of 500mm/s [19.7in./sec.] or less for standard cylinders and stroke adjusting cylinders, and 100mm/s [3.9in./sec.] or less for low speed cylinders. But when the speed and loads are high even within the allowable ranges, install an external stopper, etc., to ensure that the cylinder is not exposed to direct shocks.
7. Do not use **SGDA□Q** (rolling bearing type) as a stopper.
8. A sensor switch magnet is built into the cylinder. Mounting a sensor switch will enable to use in sensor switch applications.

Caution: For the sensor switch mounting locations and moving sensor switch guidelines, see p.696.



Mounting

Mounting

1. While any mounting direction is allowed, the mounting surface should always be flat. Twisting or bending during mounting may reduce the accuracy and may also result in air leaks or improper operation.
2. Be aware that scratches or dents on the cylinder's mounting surface may damage its flatness.
3. In applications subject to large shocks, reinforcing the bolt mounting, by mounting a support to the cylinder body for example, is recommended.
4. Ensure that the mounting bolts for the cylinder body and end plate are sufficiently strong. Also, when mounting the body, tighten to an appropriate tightening torque within the allowable range.

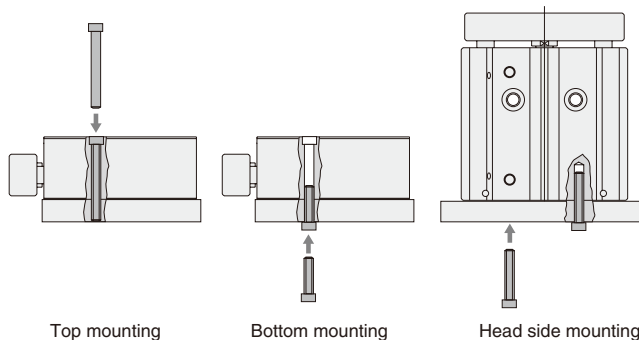

Bore size mm [in.]	Top mounting		Bottom mounting		Head side mounting	
	Mounting bolt size	Maximum tightening torque (N·m) [ft·lbf]	Mounting bolt size	Maximum tightening torque (N·m) [ft·lbf]	Mounting bolt size	Maximum tightening torque (N·m) [ft·lbf]
6 [0.236]	M3×0.5	1.14 [0.84]	M4×0.7	1.50 [1.11]	M4×0.7	1.50 [1.11]
8 [0.315]	M3×0.5	1.14 [0.84]	M4×0.7	1.50 [1.11]	M4×0.7	1.50 [1.11]
10 [0.394]	M4×0.7	2.70 [1.99]	M5×0.8	3.00 [2.21]	M4×0.7	1.50 [1.11]

Bore size mm [in.]	Mounting workpiece	
	Mounting bolt size	Maximum tightening torque (N·m) [ft·lbf]
6 [0.236]	M3×0.5	1.14 [0.84]
8 [0.315]	M4×0.7	2.70 [1.99]
10 [0.394]	M4×0.7	2.70 [1.99]

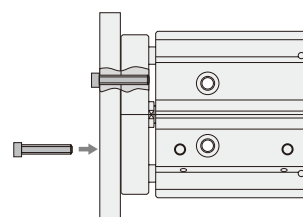

Mounting a workpiece to the end plate

5. If bolts may be loosened by shocks or vibrations, take measures such as applying locktight.
6. Do not leave scratches or dents in the sliding section of the piston rod and the guide rod. It could result in damage to the seal or in air leaks.
7. The piston rod and guide rod are coated with grease. Do not wipe it off, as it may result in improper operation. Apply grease if no lubrication is visible.

Standard cylinders and stroke adjusting cylinders :
General type; Lithium grease No.2

Low speed cylinders : Fluorine grease for low speed

Caution: If you handle the grease used in the assembly of the low speed cylinders, be sure to carefully wash your hands afterwards. If you smoke a cigarette without first washing your hands, the grease may adhere to the cigarette and produce toxic gas by burning. (While the grease used in the low speed cylinders is chemically stable at room temperature, it will produce toxic gas when heated to more than 250°C [482°F].)

Cylinder Thrust

Select a suitable cylinder bore size considering the load and air pressure to obtain the required thrust.

Since the figures in the table are calculated values, select a bore size that results in a load ratio (load ratio = $\frac{\text{Load}}{\text{Calculated value}}$) of 70% or less (50% or less for high speed application).



Bore size mm [in.]	Piston rod diameter mm [in.]	Operation	Pressure area mm ² [in ²]	Air pressure MPa [psi.]								
				0.2 [29]	0.3 [44]	0.4 [58]	0.5 [73]	0.6 [87]	0.7 [102]	0.8 [116]	0.9 [131]	1.0 [145]
6 [0.236]	3 [0.118]	Push side	28.3 [0.0439]	5.7 [1.28]	8.5 [1.91]	11.3 [2.54]	14.1 [3.17]	17.0 [3.83]	19.8 [4.46]	22.6 [5.09]	25.4 [5.72]	28.3 [6.37]
		Pull side	21.2 [0.0329]	4.2 [0.95]	6.4 [1.44]	8.5 [1.91]	10.6 [2.39]	12.7 [2.86]	14.8 [3.33]	17.0 [3.83]	19.1 [4.30]	21.2 [4.77]
		Stroke adjusting	21.2 [0.0329]	4.2 [0.95]	6.4 [1.44]	8.5 [1.91]	10.6 [2.39]	12.7 [2.86]	14.8 [3.33]	17.0 [3.83]	19.1 [4.30]	21.2 [4.77]
8 [0.315]	3 [0.118]	Push side	50.3 [0.0780]	10.1 [2.27]	15.1 [3.40]	20.1 [4.52]	25.1 [5.65]	30.2 [6.80]	35.2 [7.92]	40.2 [9.04]	45.2 [10.17]	50.3 [11.31]
		Pull side	43.2 [0.0670]	8.6 [1.94]	13.0 [2.93]	17.3 [3.89]	21.6 [4.86]	25.9 [5.83]	30.2 [6.80]	34.6 [7.79]	38.9 [8.75]	43.2 [9.72]
		Stroke adjusting	43.2 [0.0670]	8.6 [1.94]	13.0 [2.93]	17.3 [3.89]	21.6 [4.86]	25.9 [5.83]	30.2 [6.80]	34.6 [7.79]	38.9 [8.75]	43.2 [9.72]
10 [0.394]	4 [0.157]	Push side	78.5 [0.1217]	15.7 [3.53]	23.6 [5.31]	31.4 [7.07]	39.3 [8.84]	47.1 [10.60]	55.0 [12.36]	62.8 [14.12]	70.7 [15.89]	78.5 [17.65]
		Pull side	66.0 [0.1023]	13.2 [2.97]	19.8 [4.46]	26.4 [5.94]	33.0 [7.43]	39.6 [8.91]	46.2 [10.39]	52.8 [11.88]	59.4 [13.35]	66.0 [14.84]
		Stroke adjusting	66.0 [0.1023]	13.2 [2.97]	19.8 [4.46]	26.4 [5.94]	33.0 [7.43]	39.6 [8.91]	46.2 [10.39]	52.8 [11.88]	59.4 [13.35]	66.0 [14.84]

Allowable Lateral Load

● Lateral load (F) on the rod end should be at or below the figures in the table below.

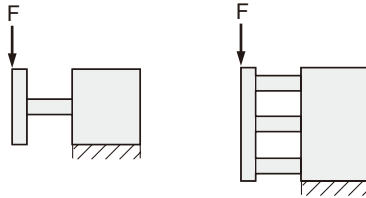

Bore size mm [in.]	Type	Stroke mm			
		5	10	15	20
6 [0.236]	Slide bearing type	7.2 [1.62]	6.0 [1.35]	5.1 [1.15]	4.5 [1.01]
	Rolling bearing type	9.4 [2.11]	7.9 [1.78]	6.8 [1.53]	6.0 [1.35]
8 [0.315]	Slide bearing type	11.7 [2.63]	10.0 [2.25]	8.8 [1.98]	7.8 [1.76]
	Rolling bearing type	19.4 [4.37]	16.7 [3.75]	14.7 [3.31]	13.1 [2.95]
10 [0.394]	Slide bearing type	19.9 [4.48]	17.3 [3.89]	15.4 [3.47]	13.8 [3.11]
	Rolling bearing type	25.7 [5.78]	22.5 [5.06]	19.9 [4.48]	17.9 [4.03]

Note: Figures in the table are static values. Consider the safety factor in accordance with operating conditions.

End Plate Non-rotating Accuracy θ

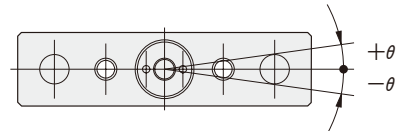

Bore size mm [in.]	SGDA, SGDAP	SGDAQ, SGDAPQ
6 [0.236]	$\pm 0.14^\circ$	$\pm 0.07^\circ$
8 [0.315]	$\pm 0.12^\circ$	$\pm 0.07^\circ$
10 [0.394]	$\pm 0.12^\circ$	$\pm 0.07^\circ$

Note: The above figures are obtained when cylinder is retracted (initial value) without load. Guide rod deflection is excluded.

Allowable Twisting Torque of the End Plate

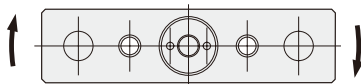

Bore size mm [in.]	Type	Stroke mm			
		5	10	15	20
6 [0.236]	Slide bearing type	0.054 [0.48]	0.045 [0.40]	0.038 [0.34]	0.034 [0.30]
	Rolling bearing type	0.071 [0.63]	0.059 [0.52]	0.051 [0.45]	0.045 [0.40]
8 [0.315]	Slide bearing type	0.099 [0.88]	0.085 [0.75]	0.075 [0.66]	0.066 [0.58]
	Rolling bearing type	0.165 [1.46]	0.142 [1.26]	0.125 [1.11]	0.111 [0.98]
10 [0.394]	Slide bearing type	0.189 [1.67]	0.164 [1.45]	0.146 [1.29]	0.131 [1.16]
	Rolling bearing type	0.244 [2.16]	0.214 [1.89]	0.189 [1.67]	0.170 [1.50]

Note: Figures in the table are static values. Consider the safety factor in accordance with the operating conditions.

Allowable Range when Used as a Stopper

φ 6 [0.236] ~ φ 10 [0.394] (Slide bearing)

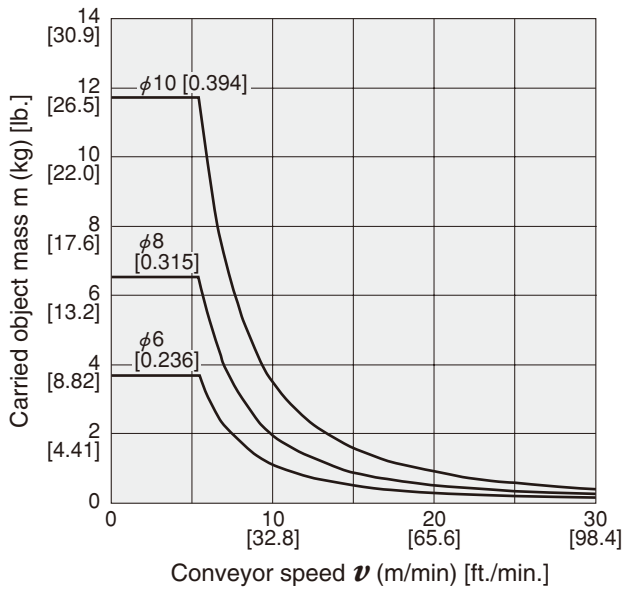

Precautions for handling

- Notes: 1. Figures assume that the carried objects are plastic containers.
 2. The rolling bearing type cannot be used as a stopper.
 3. When the stopper becomes subject to friction force produced by friction between the carried object and the conveyor, etc., keep the friction force at the allowable lateral load or less.

Allowable Load Range

Use the graph values below for the relation between the load and piston speed.

When these values are exceeded, install an external stopper.

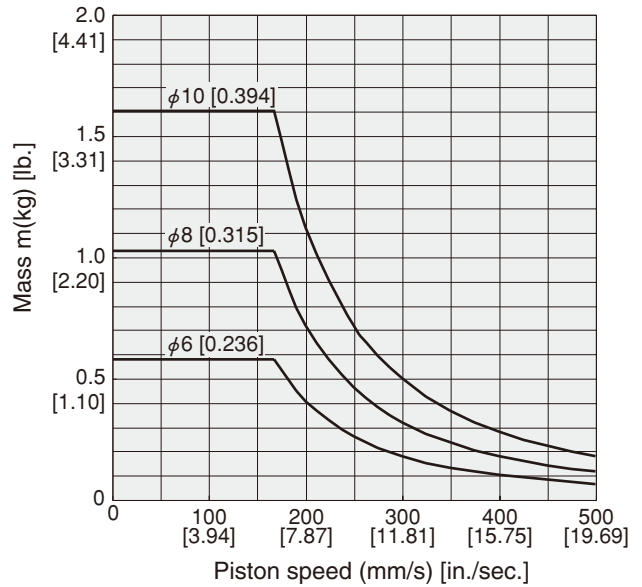

Allowable Range when Used as a Lifter

- Select a cylinder bore so that the total mass of the load is the theoretical output (in the graphs below) or less.

Bore size mm [in.]	Theoretical output
6 [0.236]	40% or less
8 [0.315]	
10 [0.394]	

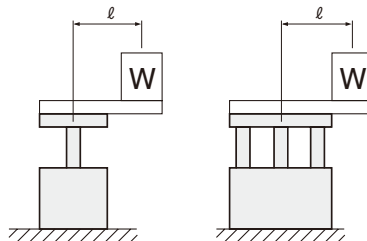

Slide bearing type (applied pressure P = 0.5MPa [73psi.])

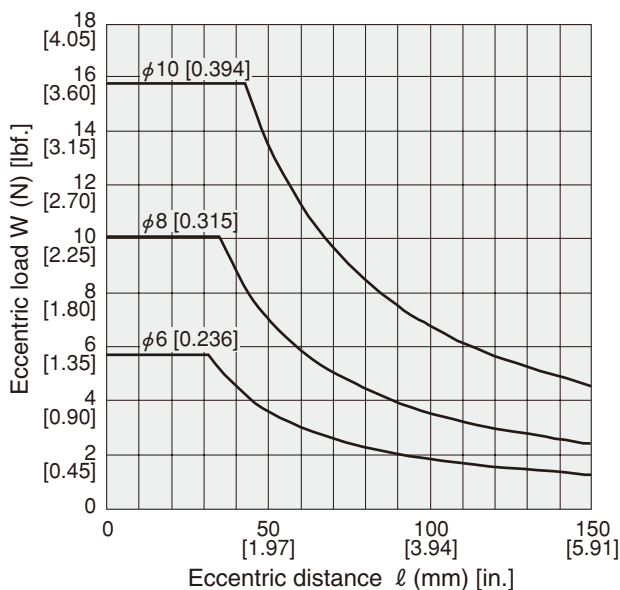

Rolling bearing type (applied pressure P = 0.5MPa [73psi.])

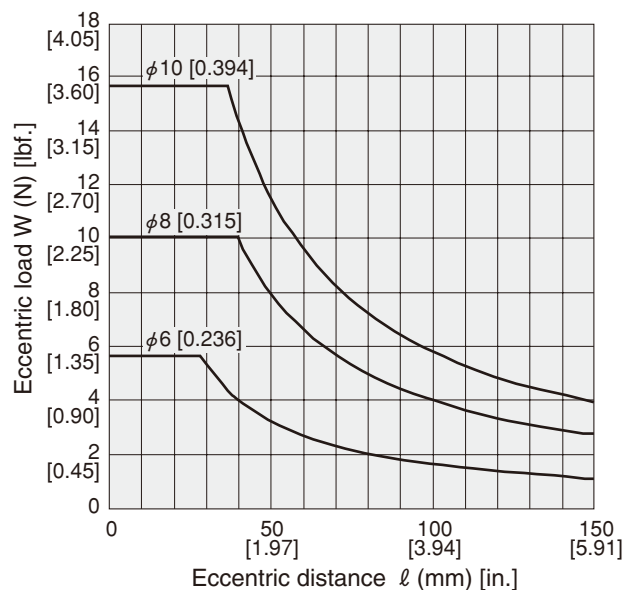

Note: Figures in the graphs are static values. Consider the safety factor in accordance with the operating conditions.

Inner Construction (cannot be disassembled)

Standard Cylinder

- SGDA6, 8
- SGDAQ6, 8

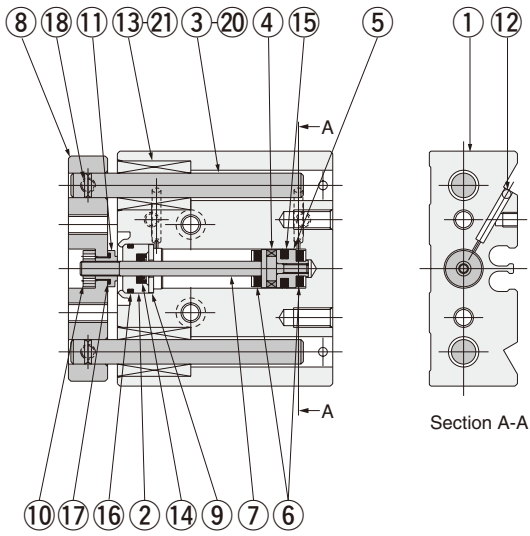

- SGDA10
- SGDAQ10

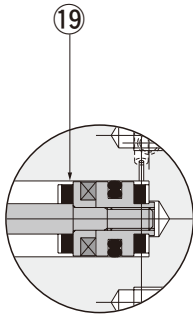

Major Parts and Materials

Standard Cylinder

No.	Parts	Bore size		
		mm [in.]	6 [0.236]	8 [0.315]
①	Cylinder body	Aluminum alloy (anodized)		
②	Rod cover	Aluminum alloy (special wear-resistant treatment)		
③	Guide rod (slide bearing type)	Steel (hard chrome plated)	Stainless steel (hard chrome plated)	
④	Magnet	Neodymium magnet		
⑤	Piston	Aluminum alloy (special rust prevention treatment)		
⑥	Bumper	Synthetic rubber (urethane)		
⑦	Piston rod	Stainless steel		
⑧	End plate	Aluminum alloy (anodized)		
⑨	Seal holder	Aluminum alloy (special rust prevention treatment)	Mild steel (zinc plated)	
⑩	Nut A	Stainless steel		
⑪	Nut B	Stainless steel		
⑫	Steel ball	Stainless steel		
⑬	Slide bearing	Aluminum alloy (special wear-resistant treatment)		
⑭	Seal (rod)	Synthetic rubber (NBR)		
⑮	Seal (piston)	Synthetic rubber (NBR)		
⑯	O-ring	Synthetic rubber (NBR)		
⑰	O-ring	Synthetic rubber (NBR)		
⑱	Small screw	Steel	Stainless steel	
⑲	Support	—	—	Aluminum alloy
⑳	Guide rod (rolling bearing type)	Steel		
㉑	Rolling bearing	Steel, plastic		

JIG CYLINDERS WITH GUIDES φ6, φ8, φ10

Mass

Bore size mm [in.]	Stroke mm	Slide bearing	Rolling bearing	Additional mass	
				Sensor switch (with 1 sensor switch)	
				ZE□□□A	ZE□□□B
6 [0.236]	5	66 [0.146]	67 [0.148]	15 [0.033]	35 [0.077]
	10	72 [0.159]	74 [0.163]		
	15	81 [0.179]	83 [0.183]		
	20	88 [0.194]	90 [0.198]		
8 [0.315]	5	100 [0.220]	104 [0.229]	15 [0.033]	35 [0.077]
	10	110 [0.242]	113 [0.249]		
	15	122 [0.269]	126 [0.278]		
	20	131 [0.289]	135 [0.298]		
10 [0.394]	5	140 [0.309]	141 [0.311]	15 [0.033]	35 [0.077]
	10	152 [0.335]	153 [0.337]		
	15	168 [0.370]	169 [0.373]		
	20	180 [0.397]	181 [0.399]		

Dimensions of Standard Cylinder (mm)

- SGDA 6, 8, 10
- SGDAQ 6, 8, 10

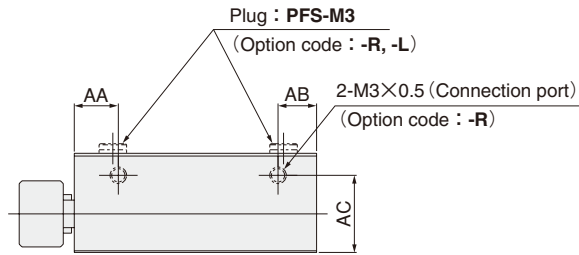
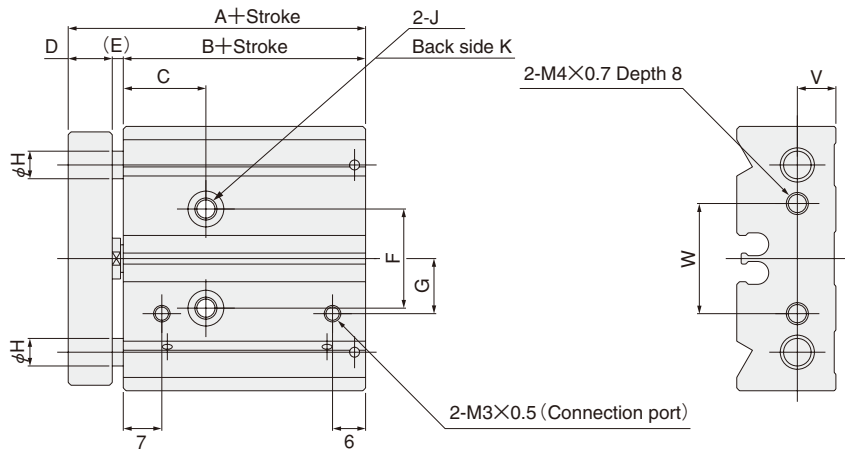
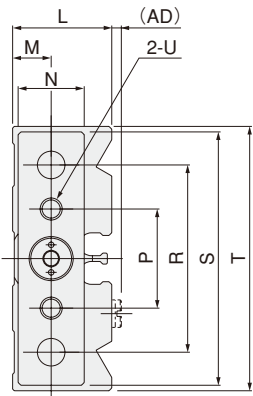
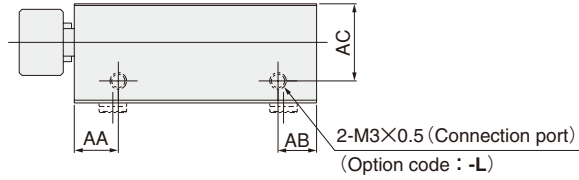

Code Model	A	B	C	D	E	F	G	H	J	K	L
SGDA6	31	23	15	6	2	16	8	4	φ 3.3 Counterbore φ 6.5 Depth 5	M4×0.7 Depth 6	15
SGDA8	34	24	15	8	2	18	10	5	φ 3.3 Counterbore φ 6.5 Depth 5	M4×0.7 Depth 6	18
SGDA10	36	26	16	8	2	20	10	6	φ 4.2 Counterbore φ 8 Depth 5	M5×0.8 Depth 10	20

Code Model	M	N	P	R	S	T	U	V	W	AA	AB	AC	AD
SGDA6	6	10	16	30	40	42	M3×0.5	6	18	9	6	11	2
SGDA8	7	12	18	34	46	48	M4×0.7	7	20	8	7	14	2
SGDA10	8	14	20	38	52	54	M4×0.7	8	22	9	7	16	2

JIG CYLINDERS WITH GUIDES $\phi 6$, $\phi 8$ and $\phi 10$

Low Speed Cylinders

Symbol

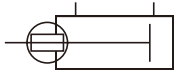

Specifications

Low Speed Cylinder

Item	Bore size mm [in.]	6 [0.236]			8 [0.315]			10 [0.394]		
Operation type		Double acting type								
Media		Air								
Operating pressure range	MPa [psi.]	0.2~1.0 [29~145]								
Proof pressure	MPa [psi.]	1.5 [218]								
Operating temperature range	°C [°F]	0~60 [32~140]								
Operating speed range	mm/s [in./sec.]	5~100 ^{Note} [0.2~3.9]								
Cushion		Rubber bumper								
Lubrication		Prohibited								
Port size		M3×0.5								
Allowable energy	J [ft·lbf]	0.008 [0.006]			0.014 [0.010]			0.022 [0.016]		
Maximum load mass	kg [lb.]	0.58 [1.28]			1.03 [2.27]			1.6 [3.53]		
Standard strokes	mm	5, 10, 15, 20								
Maximum available stroke	mm	50								
Push side stroke adjusting range	mm [in.]	$+1.5$ [$+0.059$] 0 [0]								

Note: Values are at operating pressure of 0.5MPa without load.

Order Codes

T - SG DA × - -

Low speed specification

Operation type
DA : Double acting type

Bearing specification
Blank : Slide bearing type
Q : Rolling bearing type

Bore size × Stroke

Port direction
Blank : Top side direction
R : Right side as viewed from the end plate
L : Left side as viewed from the end plate

Number of sensor switches
1 : With 1 sensor switch
2 : With 2 sensor switches

Lead wire length
A : 1000mm [39in.]
B : 3000mm [118in.]

Sensor switch type
ZE135 : Solid state type 2-lead wire DC10~28V Horizontal lead wire
ZE155 : Solid state type 3-lead wire DC4.5~28V Horizontal lead wire
ZE235 : Solid state type 2-lead wire DC10~28V Vertical lead wire
ZE255 : Solid state type 3-lead wire DC4.5~28V Vertical lead wire

mm	
Bore size	Strokes
6	5, 10, 15, 20
8	
10	

● The inner construction and major parts, mass, and dimensions, are the same as for the standard cylinders. For details, see the standard cylinders on p.690~691.

SENSOR SWITCHES

Solid State Type

Order Codes

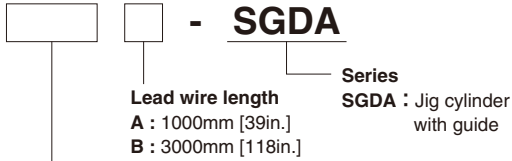

Sensor switch type

- ZE135 : Solid state type 2-lead wire DC10~28V Horizontal lead wire
- ZE155 : Solid state type 3-lead wire DC4.5~28V Horizontal lead wire
- ZE235 : Solid state type 2-lead wire DC10~28V Vertical lead wire
- ZE255 : Solid state type 3-lead wire DC4.5~28V Vertical lead wire

● For details of sensor switches, see p.1544.

Minimum Cylinder Strokes When Using Sensor Switches

● Solid state type		mm [in.]		
Item	Bore	6 [0.236]	8 [0.315]	10 [0.394]
Mounting 1 switch			1.5 [0.059]	
Mounting 2 switches			3 [0.118]	

Moving Sensor Switch

- Loosening mounting screw allows the sensor switch to be moved along the switch mounting groove of the Jig Cylinder with Guide.
- Tighten the mounting screw with a tightening torque of 0.1~0.2N·m [0.9~1.8in·lbf].

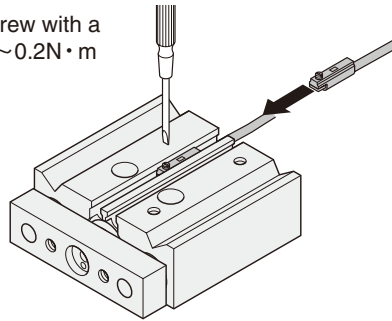

When Mounting Cylinders with Sensor Switches in Close Proximity

When mounting cylinders in close proximity, install the cylinder so that it exceeds the values in the table below.

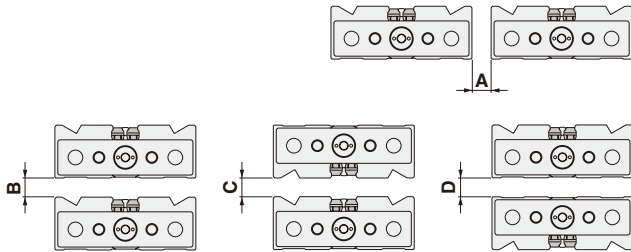

● When mounting cylinders with sensor switches in close proximity

Bore size		mm [in.]			
Item	Bore size	A	B	C	D
	6 [0.236]	0	6 [0.24]	3 [0.12]	0
	8 [0.315]	0	5 [0.20]	2 [0.08]	0
	10 [0.394]	0	12 [0.47]	8 [0.31]	0

Sensor Switch Operating Range, Response Differential, and Maximum Sensing Location

● Operating range: ℓ

The distance the piston travels in one direction, while the switch is in the ON position.

● Response differential: C

The distance between the point where the piston turns the switch ON and the point where the switch is turned OFF as the piston travels in the opposite direction.

● Solid state type

Item	Bore size	6 [0.236]	8 [0.315]	10 [0.394]
Operating range: ℓ		1.8~3.0 [0.071~0.118]	1.8~3.0 [0.071~0.118]	2.0~3.2 [0.079~0.126]
Response differential: C		0.2 [0.008] or less		
Maximum sensing location	Note	6 [0.236]		

Remark: The above table shows reference values.

Note: This is the length measured from the switch's opposite end side to the lead wire.

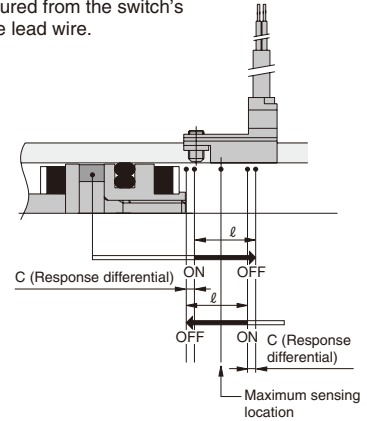

Mounting Location of End of Stroke Detection Sensor Switch

When the sensor switch is mounted in the locations shown in the diagram (the figures in the tables are reference values), the magnet comes to the maximum sensing location of the sensor switch at the end of the stroke.

● When lead wire comes to head side

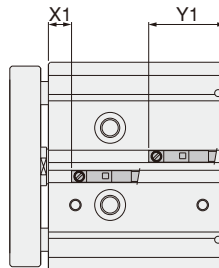

Bore size		mm [in.]		
Item	Bore size	6 [0.236]	8 [0.315]	10 [0.394]
X1		6 [0.236]	5.5 [0.217]	6 [0.236]
Y1		17 [0.669]	18.5 [0.728]	20 [0.787]

● When lead wire comes to rod side

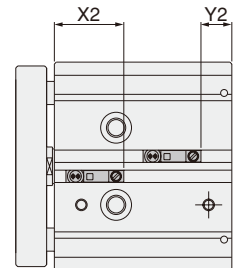

Bore size		mm [in.]		
Item	Bore size	6 [0.236]	8 [0.315]	10 [0.394]
X2		18 [0.709]	17.5 [0.689]	18 [0.709]
Y2		5 [0.197]	6.5 [0.256]	8 [0.315]