



KOGANEI

VALVES GENERAL CATALOG

TAC AIR VALVES

INDEX

| | |
|---|-----|
| Application and Combination Examples | 839 |
| Circuit Example | 840 |
| TAC Basic Valves (Push Button Type Valves) | 841 |
| TAC Manual Valves (Lever Type Valves) | 842 |
| TAC Operators for Actuating Valves (Manual/Mechanical Operated Types) | 843 |
| TAC Operators for Actuating Valves (Air Pilot Type) | 844 |
| TAC Other Components | |
| Regulator, Quick Exhaust Valve, Check Valve | 845 |
| Pneumatic-Electric Transducer Switch, Electric Switch, Volume Tank, Pressure Gauge | 846 |
| TAC ² | 847 |
| TAC Circuit Examples | 849 |

For Simple Automation Devices, Choose TAC.



TAC, a compact device for total pneumatic control, derives its acronym from the expression Tiny Air Components for Total Air Control.

The TAC series offers compact valves, virtually all of the necessary peripheral devices for the operation of small air cylinders and the easy configuration of simple pneumatic circuits.

Application examples

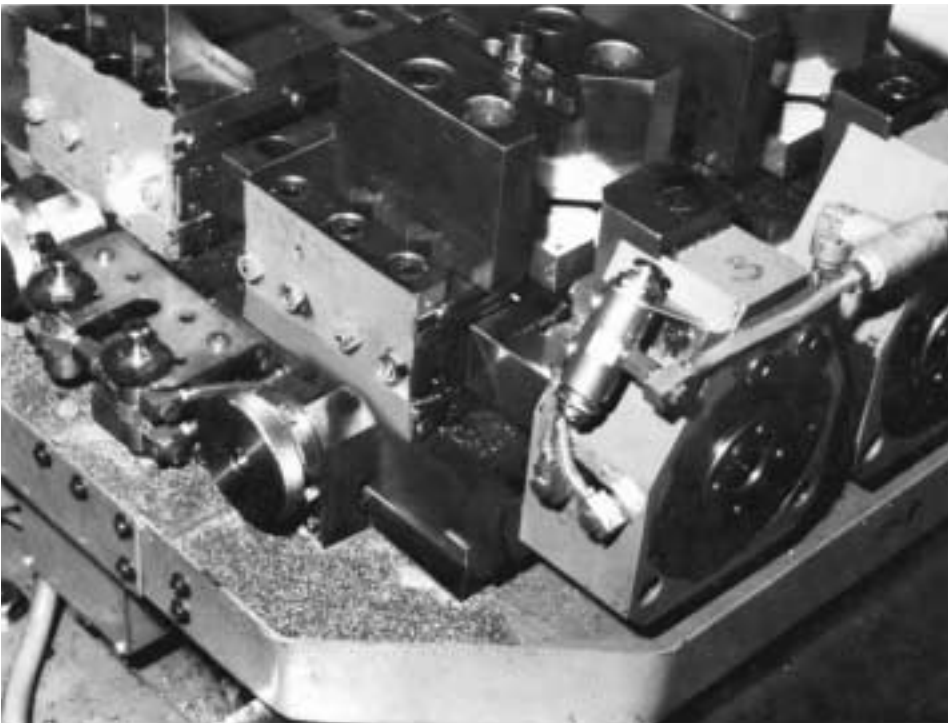

Combination examples (Combination of basic valves and operators for valves)

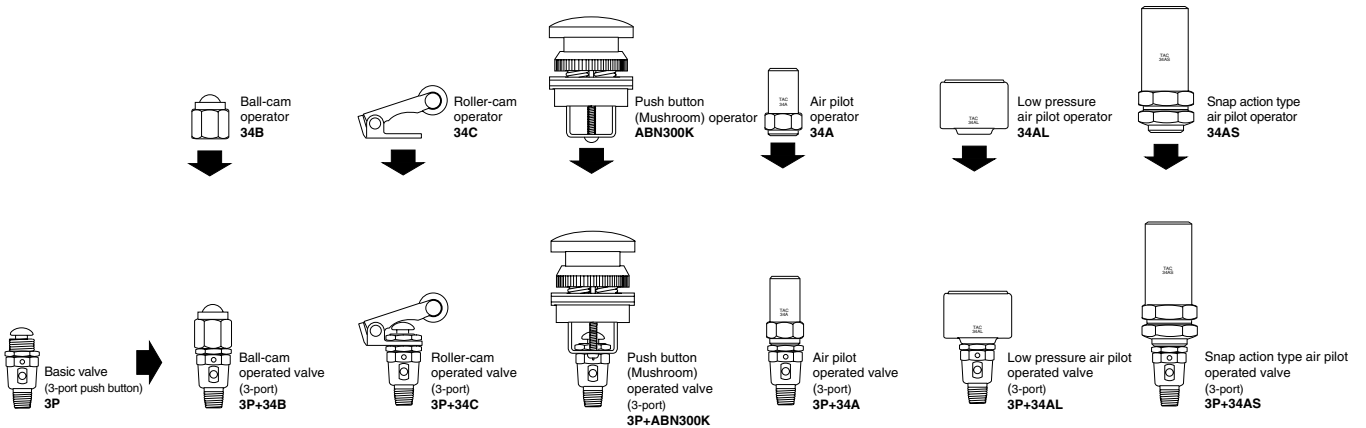

Circuit example

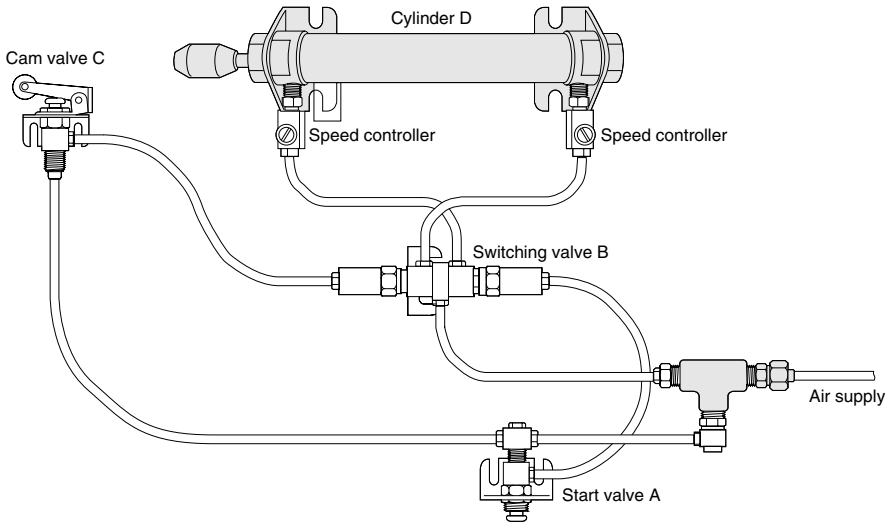

Explanation of operation

Actuation of valve A (3P) extends the rod of cylinder D, which then retracts and stops. It is often used for reliable reciprocating operation.

[Detailed explanation of operations]

- Pressing valve A supplies air to the pilot operator (34A) on the right portion of valve B (4PP), which then switches valve B.
- As a result, the air previously filled in the rod side (left side) of the cylinder is exhausted from R₂ of valve B. At the same time, air entering the cylinder head side (right side), extends the cylinder rod forward.
- At this time, when the air passes through the speed controller (SCO-F) to enter the cylinder, it opens the check valve inside the SCO-F and quickly fills in. For exhaust, however, the air is choked and the cylinder rod extends while decelerating.
- When the cylinder rod extends to push against valve C, air is applied to the air pilot operator (34A) on the left portion of valve B, restoring valve B to its normal position, and then returning the cylinder rod back.

Precautions on circuit structure

- Cylinder speed is generally determined by the bore size, and the size of the valves, speed controllers, and piping. If large cylinders are used, the valves, speed controllers, and piping must also be correspondingly large, or higher speed will not be obtained.
- Normally, use the cylinder at a speed of 500mm/s [19.7in./sec.] or less. In addition, a stopper is required when the cylinder does not have a built-in cushion, or when the load is large.
- Cylinder thrust is determined by air pressure and bore size. For details, see the separate "Air Cylinder Engineering Documents."
- Keep the piping as short as possible to ensure good response. Avoid use of tubes that have been throttled in between fittings, or tubes that are too large.
- Since valve B(4PP) is a holding type, a pulse signal is sufficient to switch it. In this circuit, it is required to press valve A (3P) and then release it. If pressed continuously without releasing, valve B will not return, and the cylinder will not be able to retract.
- Follow the directions in this catalog when connecting tubes to valve ports, etc.
- The speed controller is normally used with choking exhaust to achieve a stable speed in regard to load changes. In addition, mount it as close as possible to the cylinder's exhaust port.
- Use air through a filter, and use clean air that does not contain dust, collected liquid, degraded compressor oil, etc.
- Use Turbine Oil Class 1 (ISO VG32) or the equivalent, and ensure that the lubrication oil reaches the ends of the equipment. In particular, since lubrication is often insufficient for the operation of small-bore cylinders, take care in selecting the lubricator installing position.

Circuit diagrams

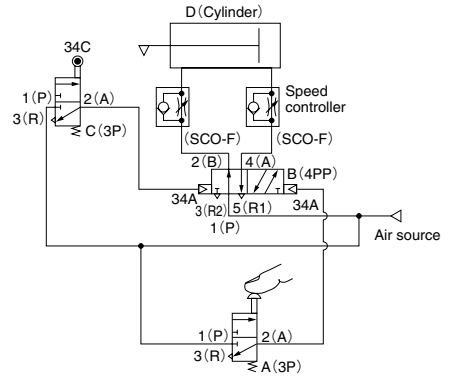

Time chart

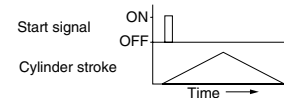

Device list

| Parts | Model | Quantities |
|--|----------|------------|
| Switching valve (3-port, push button type) | 3P | 2 |
| Switching valve (5-port, holding push button type) | 4PP | 1 |
| Air pilot operator | 34A | 2 |
| Roller-cam operator | 34C | 1 |
| Speed controller | SCO-F | 2 |
| Barbed fitting | BF5 | 14 |
| Bushing (Rc1/8-M5×0.8) | RBF | 4 |
| Universal tee fitting | UTF | 1 |
| Elbow fitting | EF | 1 |
| Bracket (angle type) | 8-600 | 3 |
| Cylinder | φ 20×100 | 1 |
| Nylon tube (φ 5×φ 3) | N5 | 1.1 m |
| Cylinder end dog | | 1 |

Caution: For speed controllers and fittings, see the General Catalog of Air Treatment, Auxiliary, Vacuum.

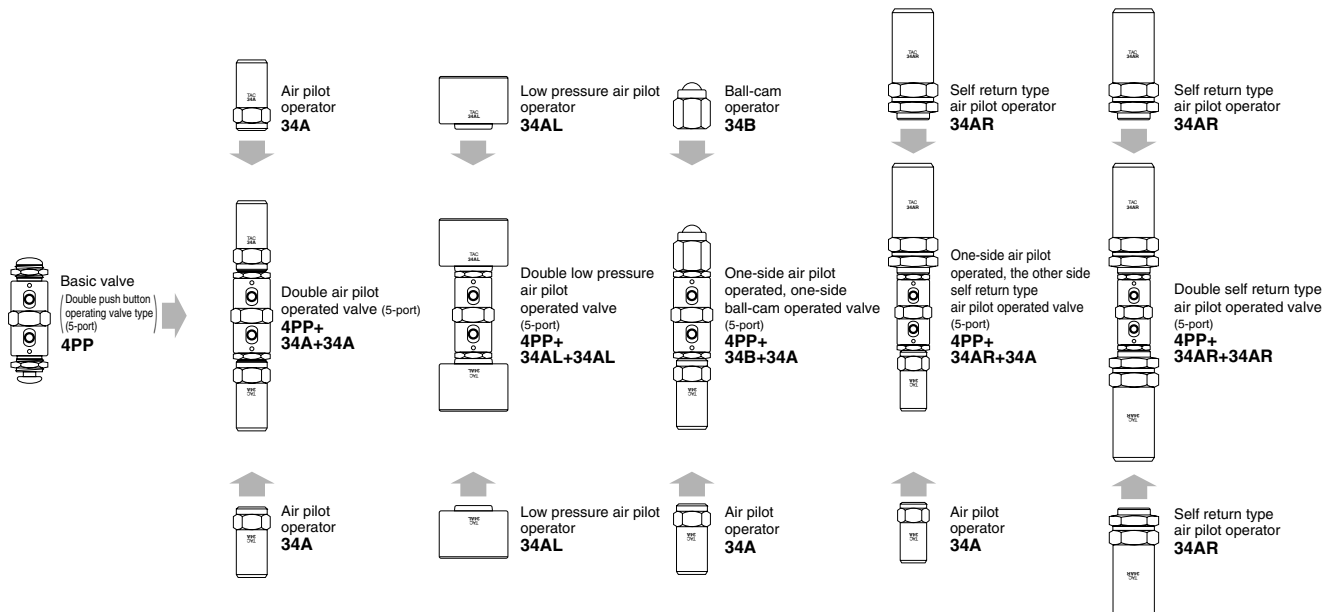

Basic Valves (Push Button Type Valves)

Operating principles

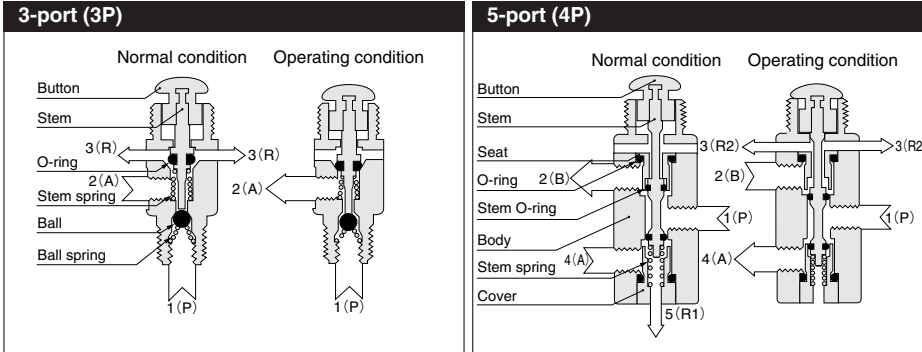

Dimensions (mm)

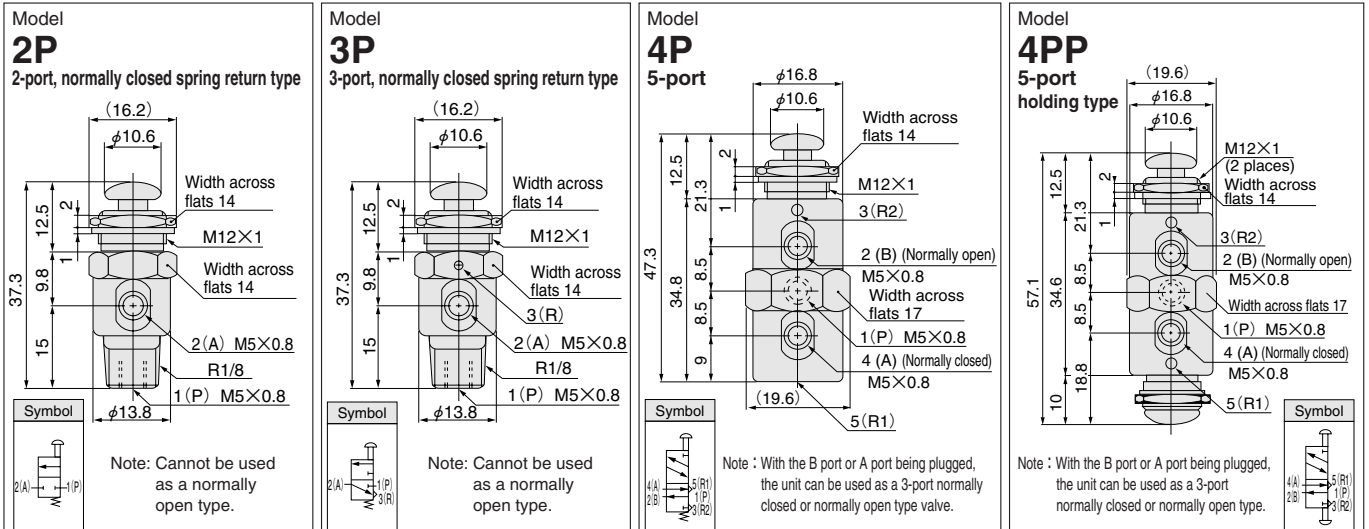

Major parts and materials

BodyBrass (nickel plated)
 StemStainless steel
 O-ringSynthetic rubber

Minimum operating force of push button

| Type | Air pressure MPa | | |
|------------|------------------------------|------------------------------|-------------------------------|
| | 0.2 [29psi.] | 0.4 [58psi.] | 0.7 [102psi.] |
| 2P | 29.4 [6.61] (19.6 [4.41]) | 44.1 [9.91] (21.6 [4.86]) | 63.7 [14.32] (23.5 [5.28]) |
| 3P | 19.6 [4.41] | 24.5 [5.51] | 29.4 [6.61] |
| 4P | 19.6 [4.41] | 21.6 [4.86] | 23.5 [5.28] |
| 4PP | 4.9 [1.10] | 5.9 [1.33] | 6.9 [1.55] |

Notes: 1. Figures in parentheses () are for when the 2(A) port is open to the atmosphere.
 2. For the operating force while used in combination with operators, see the pages of each operator.

Specifications

| Item | Model | 2P | 3P | 4P | 4PP |
|--|--|--|------------------------|-----------|---------------------------------|
| Operation type | | Push button spring return | | | Double push button holding type |
| Number of ports | | 2 (Normally closed) | 3 (Normally closed) | 5 | |
| Port size | | M5×0.8 | | | |
| Media | | Air | | | |
| Operating pressure range | MPa [kgf/cm ²] [psi.] | 0~0.9 [0~9.2] [0~131] | | | |
| Proof pressure | MPa [kgf/cm ²] [psi.] | 1.35 [13.8] [196] | | | |
| Operating temperature range (atmosphere and media) | °C [°F] | 0~60 [32~140] | | | |
| Effective area | mm ² | 1.8 | | 2.5 | |
| Flow coefficient | Cv | 0.08 | | 0.12 | |
| Mounting direction | | Any | | | |
| Maximum operating frequency | Hz | 5 | | | |
| Valve stroke | mm [in.] | 2.4 [0.094] (Pre-stroke 0.8 [0.031] Main stroke 0.8 [0.031] Over stroke 0.8 [0.031]) | | | |
| Lubrication | | Required (Turbine Oil Class 1 [ISO VG32] or equivalent) | | | |
| Mass | g [oz.] | 35 [1.23] | 30 [1.06] | 66 [2.33] | 71 [2.50] |
| Standard accessories | Lock nut (110-21A) Lock washer (100-35) | 1 pc. each | | | 2 pcs. each |

Manual Valves (Lever Type Valves)

Dimensions (mm)

Model
3V
3-port
Pinned lever holding type

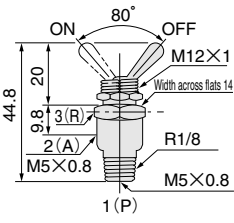

Symbol

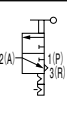

Model
3VR
3-port
Pinned lever spring return type

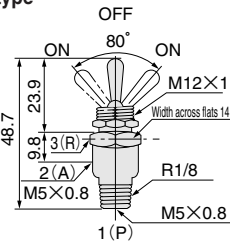

Symbol

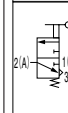

Model
4V
5-port
Pinned lever holding type

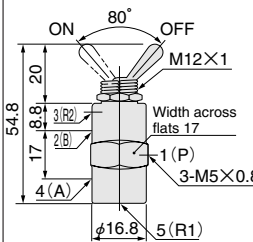

Symbol

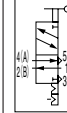

Model
4VR
5-port
Pinned lever spring return type

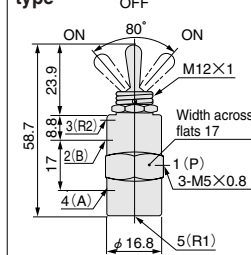

Symbol

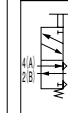

Model
4PPX
5-port
Push-pull button holding type

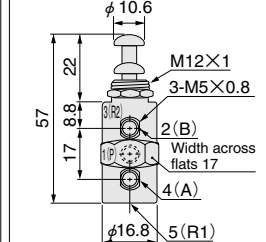

Symbol

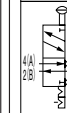

Flow rate

3-port

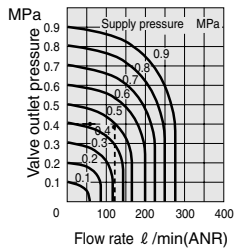

5-port

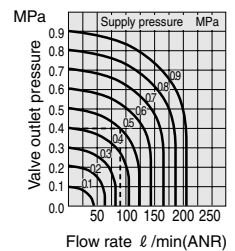

Cylinder operating speed

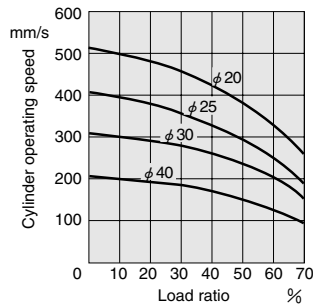

Conditions

1. Applies load from above (vertical direction).
2. Operates using a supply pressure of 0.5MPa [73psi].
3. Uses a tube with an inner diameter of 4mm [0.16in.], and a piping length of 50cm [19.7in.].

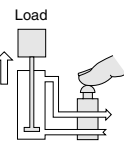

How to read the graph

When the supply pressure is 0.5MPa [73psi.] and the flow rate is 85 l/min [3.0ft³/min.] (ANR), the valve outlet pressure becomes 0.4MPa [58psi.].

1MPa=145psi., 1 l/min=0.0353ft³/min., 1mm/s=0.0394in./sec.

Specifications

| Item | Model | 3V | 3VR | 4V | 4VR | 4PPX |
|--|-----------------------------------|---|------------------------|--------------|--------------------|-------------------------------|
| Operation type | | Pinned lever | | | | Push-pull button holding type |
| | | Holding type | Spring return type | Holding type | Spring return type | |
| Number of ports | | 3 | 3 (Normally closed) | 5 | | |
| Port size | | M5×0.8 | | | | |
| Media | | Air | | | | |
| Operating pressure range | MPa [kgf/cm ²] [psi.] | 0~0.9 {0~9.2} [0~131] | | | | |
| Proof pressure | MPa [kgf/cm ²] [psi.] | 1.35 {13.8} [196] | | | | |
| Operating temperature range (atmosphere and media) | °C [°F] | 0~60 [32~140] | | | | |
| Effective area | mm ² | 1.8 | | 2.5 | | |
| Flow coefficient | Cv | 0.08 | | 0.12 | | |
| Mounting direction | | Any | | | | |
| Valve stroke | mm [in.] | 2.4 (Pre-stroke 0.8 [0.031] Main stroke 0.8 [0.031] Over stroke 0.8 [0.031]) | | | | |
| Lubrication | | Required (Turbine Oil Class 1 [ISO VG32] or equivalent) | | | | |
| Mass | g [oz.] | 30 [1.06] | | 66 [2.33] | 68 [2.40] | |
| Standard accessories | | Lock nut (110-21A) Lock washer (100-35) | | 1 pc. each | | |

Operators for Actuating Valves (Manual/Mechanical Operated Types)

(mm)

Model 34B
Ball-cam type

- The stroke is the same as the basic valve stroke.
- When mounting it on the valve, leave appropriate space by using a lock washer(100-35).

| Symbol | Materials |
|--------|--|
| | Body Brass (nickel plated) Ball Steel (chrome plated) Mass 15g [0.53oz.] |

| Minimum operating force N [lbf.] | | | |
|----------------------------------|------------------------------|------------------------------|-------------------------------|
| Air pressure MPa [psi.] | 0.2 | 0.4 | 0.7 |
| Combined valve | [29] | [58] | [102] |
| 2P | 29.4 [6.61] (19.6 [4.41]) | 44.1 [9.91] (21.6 [4.86]) | 63.7 [14.32] (23.5 [5.28]) |
| 3P | 19.6 [4.41] | 24.5 [5.51] | 29.4 [6.61] |
| 4P | 19.6 [4.41] | 21.6 [4.86] | 23.5 [5.28] |
| 4PP | 4.9 [1.10] | 5.9 [1.33] | 6.9 [1.55] |
| ES | 4.9 [1.10] | | |

Note: Figures in parentheses () are for when the 2(A) port is open to the atmosphere.

Model 34C
Roller-cam type

- The stroke is double the basic valve stroke.

| Symbol | Materials |
|--------|--|
| | Lever Mild steel (zinc plated) Roller Nylon Mass 15g [0.53oz.] |

| Minimum operating force N [lbf.] | | | |
|----------------------------------|-----------------------------|------------------------------|------------------------------|
| Air pressure MPa [psi.] | 0.2 | 0.4 | 0.7 |
| Combined valve | [29] | [58] | [102] |
| 2P | 13.7 [3.08] (9.8 [2.20]) | 19.6 [4.41] (11.8 [2.65]) | 27.5 [6.18] (14.7 [3.30]) |
| 3P | 9.8 [2.20] | 12.7 [2.85] | 14.7 [3.30] |
| 4P | 9.8 [2.20] | 11.8 [2.65] | 13.7 [3.08] |
| 4PP | 3.9 [0.88] | 4.9 [1.10] | 4.9 [1.10] |
| ES | 2.9 [0.65] | | |

Note: Figures in parentheses () are for when the 2(A) port is open to the atmosphere.

Model 34F
Foot, elbow, or palm operated type

- The valve is to be mounted on the inner bracket by using lock nuts and lock washers.
- The valve is to be sold separately.

| Symbol | Material | Mass |
|--------|--------------------------|-----------------|
| | Mild steel (zinc plated) | 300g [10.58oz.] |

Model 34T
Fingertip operated type

- A lever-type operator used for light fingertip operation.

| Symbol | Material | Mass |
|--------|--------------------------|---------------|
| | Mild steel (zinc plated) | 17g [0.60oz.] |

Model ABN
Push button type

Model ASN
Select type

- Electric switch operator type. Use them in combination with any of the basic valves.
- The holes for mounting operators on the panel are all $\phi 30$.
- For the selector type, use the lock washer supplied to adjust the valve mounting location.

| Parts | Push button type | | Selector type | |
|--------------|---|--|----------------|-----------------|
| | Model | Dimensions | Model | Dimensions |
| | ABN100K | | ASN300K | |
| | | ABN300K | | ASN3K00K |
| Symbol | | | | |
| Button color | Red, black and green buttons are standard equipment | Black (standard) (If you need a red button, specify when ordering.) | Black | Chrome plated |
| Mass | 62g [2.19oz.] | 75g [2.65oz.] | 76g [2.68oz.] | 117g [4.13oz.] |

Operators for Actuating Valves (Air Pilot Type)

(mm)

Model 34A
Air pilot (medium pressure) type

● When the pilot port receives a pneumatic signal, it switches the valve.

| | |
|---------------|--|
| Symbol | Maximum operating pressure... 0.9MPa [9.2kgf/cm ²] [131psi.] |
| | Proof pressure 1.35MPa [13.8kgf/cm ²] [196psi.] |
| | Body material..... Brass (nickel plated) |
| | Lubrication..... Required |
| | Mass 29g [1.02oz.] |

Minimum pilot pressure MPa [psi.]

| Applicable valve | Air pressure MPa [psi.] | 0.2 [29] | 0.4 [58] | 0.7 [107] |
|------------------|-------------------------|-------------|-----------|------------------------|
| 2P | 0.4 [58] | (0.25 [36]) | 0.54 [78] | (0.26 [38]) 0.72 [104] |
| 3P | 0.24 [35] | | 0.26 [38] | 0.34 [49] |
| 4P | 0.24 [35] | | 0.25 [36] | 0.25 [36] |
| 4PP | 0.08 [12] | | 0.08 [12] | 0.08 [12] |

Note: Figures in parentheses () are for when the A port is open to the atmosphere.

Model 34AL
Air pilot (low pressure) type

● When the pilot port receives a pneumatic signal, it switches the valve.

| | |
|---------------|--|
| Symbol | Maximum operating pressure... 0.9MPa [9.2kgf/cm ²] [131psi.] |
| | Proof pressure 1.35MPa [13.8kgf/cm ²] [196psi.] |
| | Body material..... Brass (nickel plated) |
| | Lubrication..... Required |
| | Mass 90g [3.17oz.] |

Minimum pilot pressure MPa [psi.]

| Applicable valve | Air pressure (main) MPa [psi.] | 0.2 [29] | 0.4 [58] | 0.7 [102] |
|------------------|--------------------------------|------------|----------|----------------------|
| 2P | 0.07 [10] | (0.05 [7]) | 0.1 [15] | (0.05 [7]) 0.12 [17] |
| 3P | 0.05 [7] | | 0.05 [7] | 0.06 [9] |
| 4P | | | 0.05 [7] | |
| 4PP | | | 0.03 [4] | |
| ES | | | 0.03 [4] | |

Note: Figures in parentheses () are for when the A port is open to the atmosphere.

Model 34AS
Air pilot snap action type

● When the pneumatic signal applied to this operator builds up pressure to 0.25±0.03MPa [36±4psi.], it immediately activates (snap action), and switches the valve. Use in timer circuits, etc., in which pilot pressure in circuits gradually builds up and accumulates.

| | |
|---------------|--|
| Symbol | Operating pressure range... 0.22~0.9MPa [2.2~9.2kgf/cm ²] [32~131psi.] |
| | Operating pressure 0.25±0.03MPa [2.5±0.3kgf/cm ²] [36±4psi.] |
| | Proof pressure 1.35MPa [13.8kgf/cm ²] [196psi.] |
| | Body material..... Brass (nickel plated) |
| | Lubrication..... Required |
| | Mass 132g [4.66oz.] |

Attach bracket or lock nut t=2.

Operating principles

Normal condition Operating condition

Remark: Application example is on p.849.

Model 34AR
Air pilot self return type

● This operator provides a special function, in that it is immediately activated upon receiving air pilot pressure of at least 0.27MPa [39psi.], and then returns to its original position after about 0.5 seconds, even if the pilot pressure is applied continuously.

● When combined with a holding type valve(4PP), the valve can return to its original position even if the air pilot is only applied on one side.

● Mainly used in one-shot circuits, this operator can help to build a simple circuit.

● Give the air pilot plenty of flow rate margin. It cannot be used by gradually building up the pressure.

| | |
|---------------|---|
| Symbol | Operating pressure range 0.27~0.9MPa [2.8~9.2kgf/cm ²] [39~131psi.] |
| | Operating pressure..... 0.27MPa [2.8kgf/cm ²] [39psi.] |
| | Proof pressure 1.35MPa [13.8kgf/cm ²] [196psi.] |
| | Body material..... Brass (nickel plated) |
| | Lubrication..... Required |
| | Mass 122g [4.30oz.] |

Operating principles

Normal condition Operating condition 1 Operating condition 2

Pilot OFF Pilot ON Pilot ON

Remark: Application example is on p.849.

(mm)

Model
RSR
Regulator (relieving type)

Model
RNR (Semi-standard)
Regulator (non-relieving type)

- Either reduces or maintains pressure to activate pneumatic components in a stable condition.

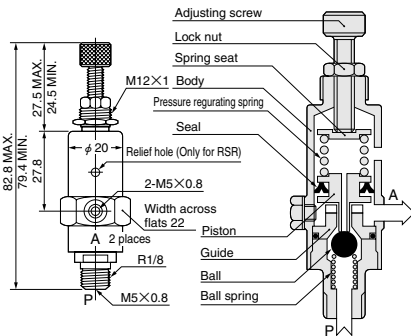

| Symbols | |
|----------------|--------------------|
| Relieving type | Non-relieving type |
| | |
| RSR | RNR |

Specifications

| Item | Model | RSR | RNR (semi-standard) |
|--|--|---|---------------------|
| Operation type | | Relieving type | Non-relieving type |
| Port size | | P: R1/8 (male thread) or M5x0.8 (female thread) A: M5x0.8 (2 places) | |
| Maximum operating pressure MPa(kgf/cm ²) [psi] | | 0.93 (9.5) [135] | |
| Operating pressure range MPa(kgf/cm ²) [psi] | | 0.2~0.7 {2.0~7.1} [29~102] | |
| Mounting direction | | Any | |
| Material | Body | Brass (nickel plated) | |
| | Seal | Synthetic rubber | |
| Mass | g [oz.] | 108 [3.81] | |
| Standard equipment | Lock nut(110-21A) Lock washer(100-35) | 1 pc. each | |

Note: For low-pressure application, consult us.

Flow rate

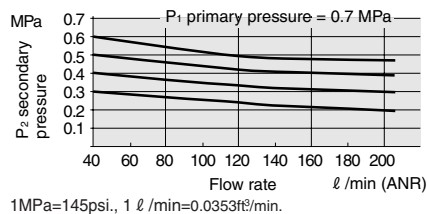

Model
SQE
Quick exhaust valve (also used as a shuttle valve)

- Can be used for quick exhaust of air from air cylinders, air tanks, or circuits. And when used as a shuttle valve, it can be used for changing flows from 2 directions to a single direction.

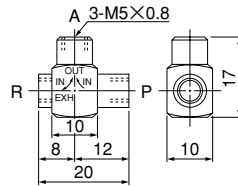

Operating principles

When used as a quick exhaust valve

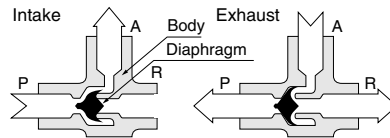

When used as a shuttle valve

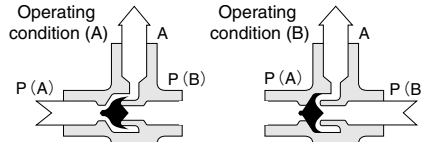

Specifications

| Item | Specifications | |
|----------------------------|--|------------------|
| Minimum operating pressure | 0.03MPa (0.3kgf/cm ²) [4psi] | |
| Effective area | 2.5mm ² | |
| Flow coefficient | Cv 0.12 | |
| Material | Body | Brass |
| | Diaphragm | Synthetic rubber |
| Mass | g [oz.] | 10 [0.35] |

Flow rate

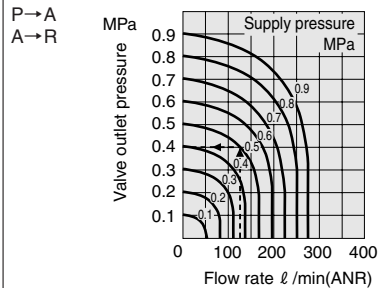

Model
C1
Check valve

- Enables media to flow in one direction, and prevent it from flowing in the opposite direction.

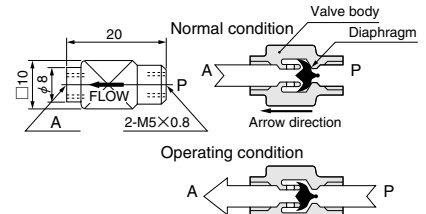

Specifications

| Symbol | Specifications | |
|----------|----------------------------|--|
| | Minimum operating pressure | 0.03MPa (0.3kgf/cm ²) [4psi] |
| | Effective area | 2.5mm ² |
| | Flow coefficient | Cv 0.12 |
| Material | Body | Brass (nickel plated) |
| | Diaphragm | Synthetic rubber |
| Mass | g [oz.] | 7 [0.25] |

Flow rate

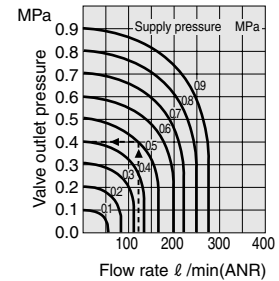

Model ESA Pneumatic-electric transducer switch

Symbol

This switch is used to transduce pneumatic signals to electrical signals, with a already assembled micro switch and dedicated operator.

- For the timer circuit or for obtaining a pulse signal, use another model **ES**, and use it in combination with the various operators.
- The micro switch (with lock nut) order code is **ESL**, while the order code for its dedicated air pilot operator is **EA** (**ESL+EA=ESA**).

Specifications

| | | |
|--------------------------------------|-----------------------------------|---|
| Operating pressure range (air pilot) | MPa {kgf/cm ² } [psi.] | 0.06~0.9 {0.6~9.2} [9~131] |
| Maximum operating frequency | Hz | 5 |
| Micro switch rating | AC 250V 15A DC 30V 6A | |
| Material | Operator body | Brass (nickel plated) |
| | Seal | Synthetic rubber |
| | Micro switch body | Plastic |
| Mass | g [oz.] | 120 [4.23] |
| Standard equipment | | 1 pc. lock nut (spacer) |
| Micro switch model | | OMRON Z-15GQ-B (standard) (Remove the plunger's stop ring when using) |

Remark: More compact models are available. Consult us.

Model ES Electric switch (with adapter)

Symbol

This example is mounting operator 34AS

This switch is used in combination with various operators for transducing pneumatic signals to electrical signals.

- When using in combination with operators, attach the supplied **ES** adapter (Model **6-71A**) as shown in the diagram.
- Cannot be used in combination with **34A**. When using it as a general pneumatic electric transducing switch, use another model **ESA**.
(Since the **34A** does not have a built-in spring, it could occasionally fails to return properly.)

Symbol

- Maximum operating cycles 5Hz
- Mass 63g [2.22oz.]
- Materials
Body Brass (nickel plated)
Adapter Brass (nickel plated)
Collar Delrin plastic

Example of the combination of ES and operator

| | | |
|---------------------------------------|--|------------------|
| P/E transducing of low pressure | 0.3-2kgf/cm ² [4-28psi.] G | ES+34AL |
| Timer circuit | | ES+34AS |
| In the case of receiving pulse signal | | ES+34AR |
| P/E transducing of medium pressure | Specify another | |
| | 0.6~9kgf/cm ² [9~128psi.] G | model ESA |

Remark: The micro switch is the same as the one for **ESA**.

Note: When using in combination with **34AL**, do not use the **ES** adapter's collar.

Model V15 Volume tank 15cc [0.915in³]

Model V30 Volume tank 30cc [1.830in³]

● Used as an air reservoir, etc., for air timers.

Specifications

| Item | Model | V15 | V30 |
|----------------|-----------------------------------|---|------------|
| Volume | cc [in ³] | 15 [0.915] | 30 [1.830] |
| Port size | | M5×0.8 | Rc 1/8 |
| Proof pressure | MPa (kgf/cm ²) [psi.] | 1.35 [13.8] [196] | |
| Materials | | Steel sheet (nickel plated on both sides) | |
| Mass | g [oz.] | 44 [1.55] | 103 [3.63] |

- Maximum setting time when used normally in combination with the speed controller SC0, etc.
V15: approximately 5 seconds, V30: approximately 10 seconds
- If moisture is included in the compressed air, the moisture can accumulate and cause instability in the setting time.
Use dry air. In addition, install the tank in a way not to collect water.

Model PG1 Pressure gauge

Symbol

Specifications

| | |
|----------------------------|--|
| Maximum operating pressure | 0.9MPa [9.2kgf/cm ²] [131psi.] |
| Proof pressure | 1.35MPa [13.8kgf/cm ²] [196psi.] |
| Mass | g [oz.] 90 [3.17] |

TAC²

Operating principles

All ports can be used to allow flows in the reverse direction.

3-port 31P

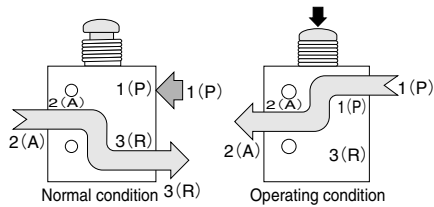

※ When used as a 3-port normally closed type

5-port 41P

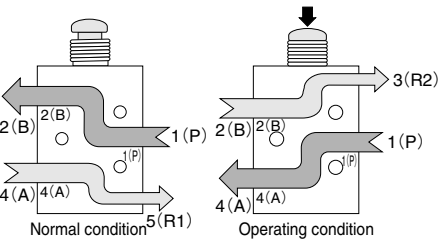

● When used as a 5-port valve

Specifications

| Media | | Air |
|--|-----------------------------------|---|
| Operating pressure range | MPa [kgf/cm ²] [psi.] | 0.05~0.9 {0.5~9.2} [7~31] (For pilot pressure, see the numeric values of each operator) |
| Proof pressure | MPa [kgf/cm ²] [psi.] | 1.35 {13.8} [196] |
| Effective area | mm ² | 5.5 |
| Flow coefficient | Cv | 0.27 |
| Air flow rate (at 0.7MPa [102psi.] (ANR)) | ℓ / min [ft ³ /min.] | Approximately 500 [17.7] |
| Operating temperature range (atmosphere and media) | °C [°F] | 0~60 [32~140] |
| Maximum operating frequency | Hz | 5 |
| Valve stroke | mm [in.] | 2.4 [0.094] $\left(\begin{array}{l} \text{Pre-stroke 0.8 [0.031]} \\ \text{Main stroke 0.8 [0.031]} \\ \text{Over stroke 0.8 [0.031]} \end{array} \right)$ |
| Lubrication | | Required (Turbine Oil Class 1 (ISO VG32) or equivalent) |
| Port size | | Rc1/8 female thread (3(R2), 5(R1) port of 5-port valve: M5×0.8) |
| Materials | Body Stem | Aluminum alloy (electroless nickel plating) (Stem of 31V, 41V : Stainless steel) |
| | O-ring | Synthetic rubber |

Application example

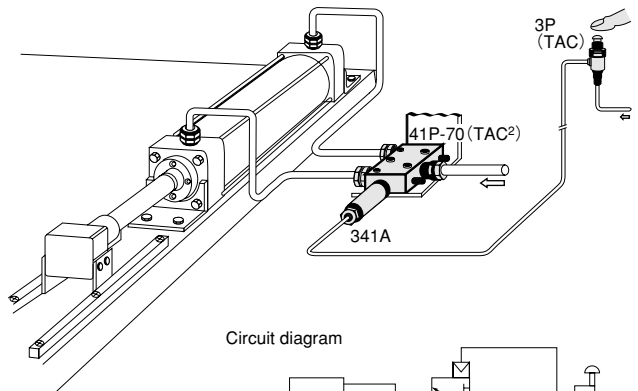

Circuit diagram

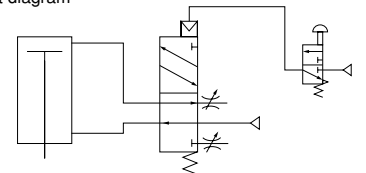

Example of valve and operator combination, and its operation

41P, 341A

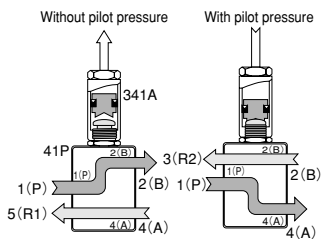

41PP, 34AR (self return type)

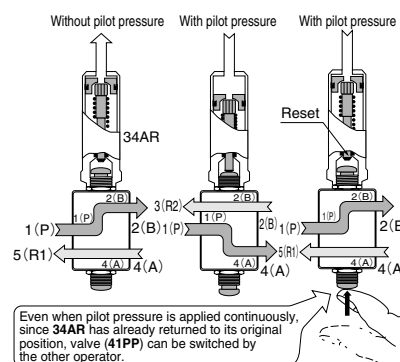

While the 34AR operates immediately after receiving pilot pressure, it returns to its original position after 0.3~0.5 second.

Note: Ensure that adequately large flow rate of pilot air is applied to 34AR. (Do not supply flows gradually.)

Even when pilot pressure is applied continuously, since 34AR has already returned to its original position, valve (41PP) can be switched by the other operator.

Model

31P Push button spring return type 3-port, for both NC and NO

Depending on the piping procedure, the following usage is allowed.

- 2-port, normally closed (3(R) port plugged)
- 2-port, normally open (1(P) port plugged)
- 3-port, normally closed (1(P) port used as IN)
- 3-port, normally open (3(R) port used as IN)
- Divider valve
[Use the 2(A) port as IN, the 1(P) port and 3(R) port as OUT.]
- Selector valve (Dual-pressure switching valve)
[Use the 1(P) port and 3(R) port as IN ports with different pressures.]

■ Mass 55g [1.94oz.]

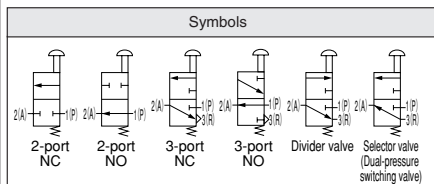
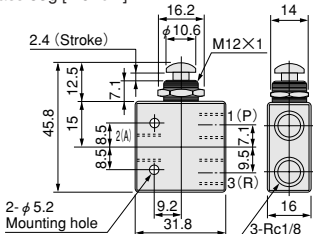

Model

41P Push button, spring return type

- 5-port
[Plugging the 2(B) port makes a 3-port NC (normally closed) type, while plugging the 4(A) port makes a 3-port NO (normally open) type. Both the 4(A) and 2(B) ports can also be used as IN ports.]
- A speed controller can be built-in. (Order code 41P-70)
[The speed controller can be removed to attach a muffler (Model 150-30A, to be ordered separately) in its place.]

■ Mass 70g [2.47oz.]

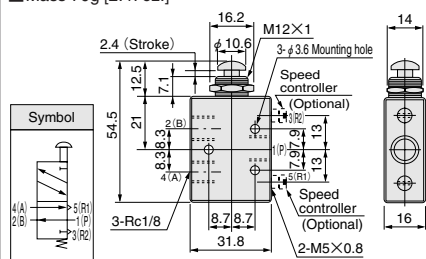

Model

41PP Push button, double action, holding type

- 5-port
[Plugging the 2(B) port makes a 3-port NC (normally closed) type, while plugging the 4(A) port makes a 3-port NO (normally open) type.]
- A speed controller can be built-in. (Order code 41PP-70)
[The speed controller can be removed to attach a muffler (Model 150-30A, to be ordered separately) in its place.]

■ Mass 75g [2.65oz.]

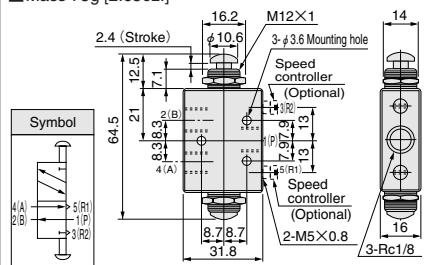

Model

31V Pinned lever, holding type 3-port, for both NC and NO

As with the 31P type, various usage is possible depending on the used piping.

■ Mass 55g [1.94oz.]

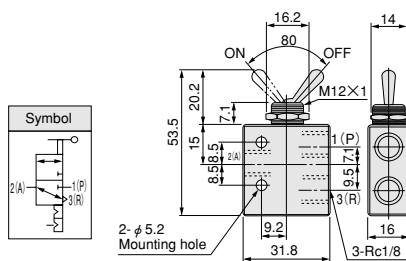

Model

41V Pinned lever, holding type

- 5-port
- Speed controller can be built-in. (Order code 41V-70)
[The speed controller can be removed to attach a muffler (Model 150-30A, to be ordered separately) in its place.]

■ Mass 70g [2.47oz.]

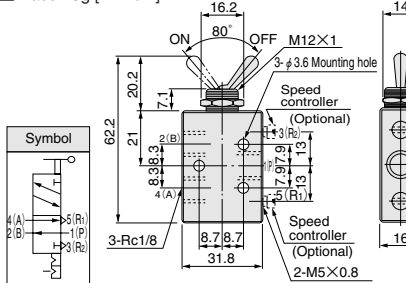

Model

341A Air pilot operator

- This operator is used in combination with 2P, 3P, 4P, 4PP, 31P, 41P, 41PP, and other basic valves, to offer air pilot valves.
- The piston area is about 1.7 times larger than the 34A type, and can therefore generate an operating force 1.7 times larger with the same pilot pressure.
- Material: Brass (nickel plated)

■ Mass 30g [1.06oz.]

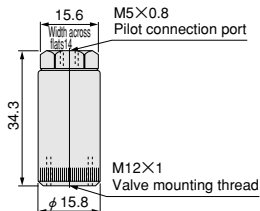

Model

150-30A Muffler

- To be screwed into the R port of the 41P, 41PP, and 41V for use.
- Material: Sintered brass
- With gasket

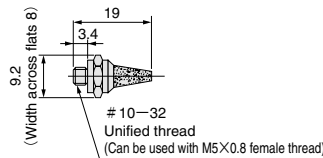

Flow rate

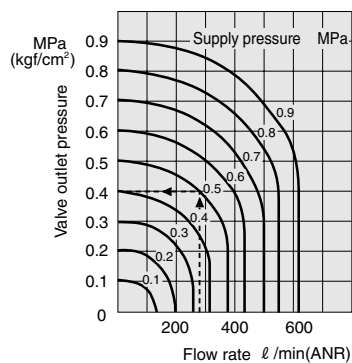

1MPa=145psi., 1 l / min=0.035ft.³/min.

How to read the graph

When the supply pressure is 0.5MPa [73psi.] and the flow rate is 275 l / min [9.71ft.³/min.] (ANR), the valve outlet pressure becomes 0.4MPa [58psi.].

Cylinder operating speed

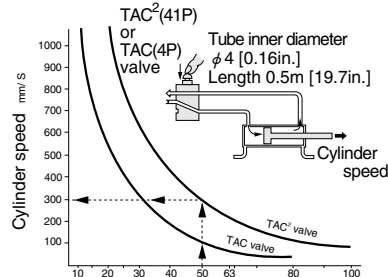

How to read the graph
When using a TAC² valve with a cylinder bore size φ 50 [1.969in.], a speed of about 300mm/s [11.8in./sec.] can be obtained.

Conditions

Air pressure: 0.4~0.7MPa [58~102psi.]. Load: 0~1/3 of cylinder thrust (Speed is virtually constant with pressure of 0.4MPa [58psi.] or more, and/or with load ratio of up to 1/3).

Operating time

| Air-piloted valves | Pilot valve | s | |
|--------------------|---|------------------|------|
| | | TAC ² | TAC |
| 254-4A | Valve: ON (switching air flowing state to 1(P)→4(A)) Valve: OFF (switching air flowing state to 1(P)→2(B)) | 0.04 | 0.06 |
| 375-4A | Valve: ON (switching air flowing state to 1(P)→4(A)) | 0.05 | 0.07 |
| 501-4A | Valve: OFF (switching air flowing state to 1(P)→2(B)) | 0.12 | 0.16 |
| 750-4A | Valve: ON (switching air flowing state to 1(P)→4(A)) Valve: OFF (switching air flowing state to 1(P)→2(B)) | 0.06 | 0.09 |
| 1000-4A | Valve: ON (switching air flowing state to 1(P)→4(A)) | 0.10 | 0.16 |
| 1250-4A | Valve: OFF (switching air flowing state to 1(P)→2(B)) | 0.20 | 0.27 |

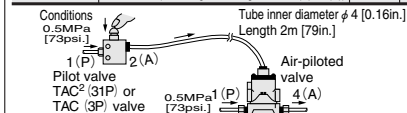

How to read the table

When used in combination with air-piloted valves 254-4A, switching time is about 0.04 seconds after actuating the TAC², and about 0.10 seconds after closing it.

(Examples of pneumatic control by the TAC air valve)

1. Operation of single acting air cylinder (Direct operation of compact single acting air cylinder)

Actuating valve A extends cylinder B's rod, and unactuating it retracts the rod.

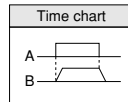
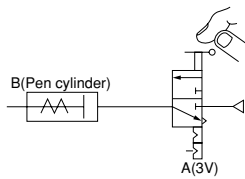

2. Operation of large air cylinder (Indirect operation by a large valve)

Actuating valve A extends cylinder B's rod, and unactuating it retracts the rod.

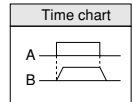
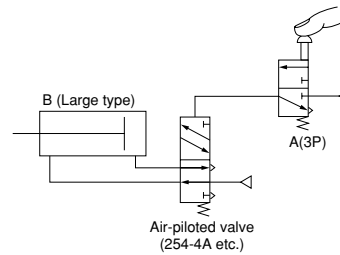

3. Operation of double acting air cylinder (Operating compact air cylinder by momentary air signal)

Actuating valve A extends cylinder C's rod, while actuating valve B retracts the rod. Since the valve (4PP) operating the cylinder is a holding type, only a momentary air signal from valve A or B is required.

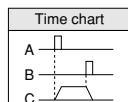
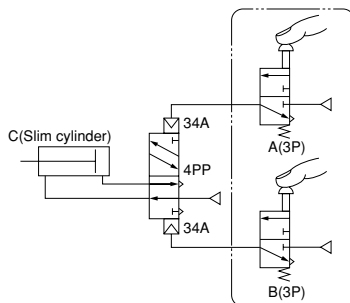

4. AND circuit (Operation of double acting air cylinder)

Actuating both valves A and B extends cylinder C's rod, and unactuating either A or B retracts the rod.

It is used in a safe operation circuit of press machines or in a checking circuit for proceeding to the next step after checking at least 2 actions.

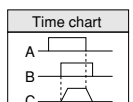
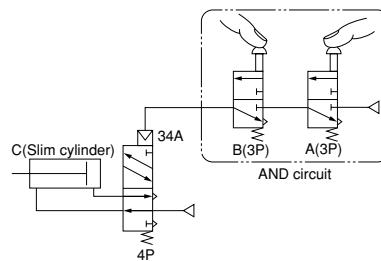

5. OR circuit (Operation of double acting air cylinder)

Actuating either valve A or B extends cylinder C's rod, and unactuating both retracts the rod.

Used when needing any of 2 or more signals to actuate.

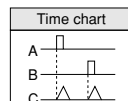
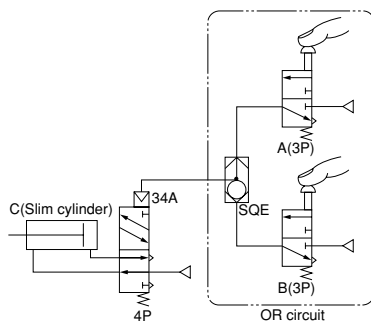

6. One reciprocating operation of air cylinder (Reliable operation)

Actuating valve A extends cylinder B's rod, then retracts and stops.

Often used as a method for a secure single reciprocating operation.

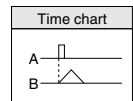
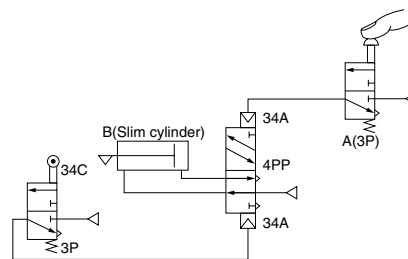

7. One reciprocating operation of air cylinder (Timing operation)

Actuating valve A extends cylinder B's rod, pauses it for a moment, then retracts it and stops. Often used for simple single reciprocating operations when reliable operation is not so required.

[Detailed explanation of operation]

The air pushing the cylinder passes at the same time through a throttle valve (SCO) into a volume tank (V15) where it gradually builds up pressure. Once it exceeds a certain level, the air activates a snap-action type operator (34AS), actuates a switching valve (4PP) and retracts the rod.

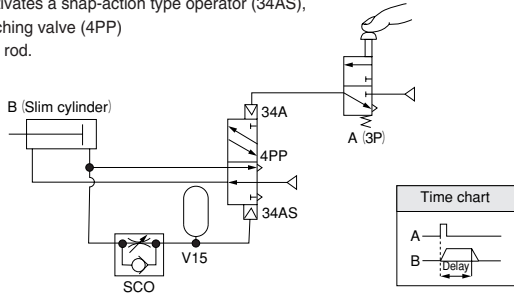

8. One reciprocating operation of air cylinder (Timing operation)

Actuating valve A extends cylinder B's rod, then retracts it after a set period and stops. While this method is accurate for delay time settings than the circuit mentioned in 7, it is often used as a method for simple single reciprocating operation that does not require that much reliability.

[Detailed explanation of operation]

The air exhausted from valve A(3V) activates a self-return type operator (34AR) to actuate the switching valve (4PP) and push the cylinder rod. At the same time, the air passes through a throttle valve (SCO) into a volume tank (V15), where air is gradually accumulated. Once it exceeds a certain level, the air activates a snap-action type operator (34AS), actuating a switching valve (4PP) and retracting the rod. At this time, the 34AR has already returned, and 34AS can be used to actuate the switching valve back to its normal position.

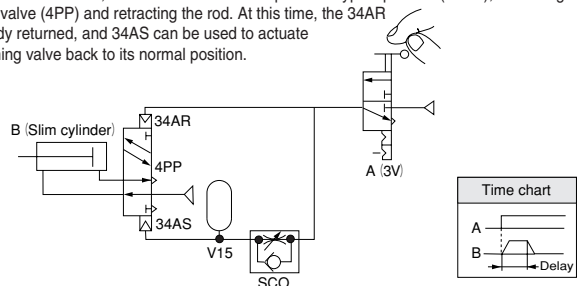

9. Continuous reciprocating operation of air cylinder

Actuating valve A starts continuous operation of cylinder B. Unactuating it stops the cylinder rod at its retracted position.

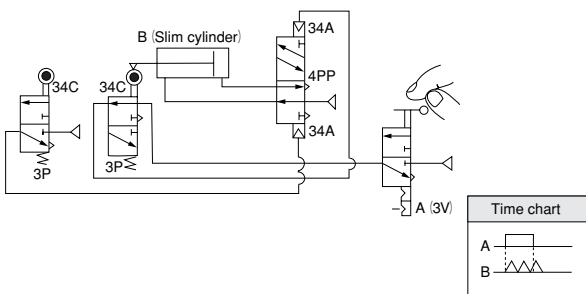

10. Delay circuit (On delay timer circuit)

Actuating valve A extends cylinder B's rod after a certain delay time. Unactuating it immediately retracts the rod. Used when a not particularly precise "delay time" ranging from about 0 to 10 seconds is required.

[Detailed explanation of operation]

Air exhausted from valve A(3V) is passed through a throttle valve (SCO) into a volume tank (V15), where it gradually builds up pressure. Once it exceeds a certain level, the air activates a snap-action type operator, actuating a switching valve (3P) and extending the cylinder rod. Unactuating valve A causes air inside the 34AS to open a check valve inside the SCO, from where air is quickly exhausted.

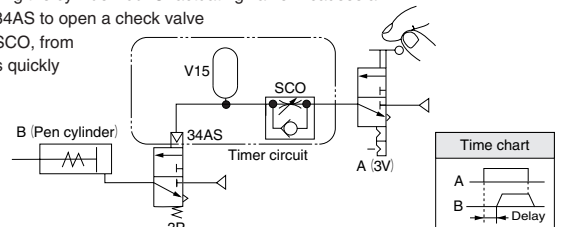

11. Step operation circuit (Binary counter circuit)

Actuating valve A one time extends cylinder B's rod, while actuating A one more time retracts the rod.

Used when a separate, single action is required once in every several actions.

[Detailed explanation of operation]

Pressing valve A(3P)(press and release), supply air through the upper shuttle valve (SQE) which activates the upper self-return type operator (34AR), actuating the holding type switching valve (4PP) and extending the cylinder rod. At this time, while air has been in the lower 34AR from the beginning, the upper 34AR can actuate the 4PP (the unique operation of 34AR lets it return the plunger even with air in its interior). Pressing A one more time actuates the lower 34AR, actuating 4PP, and a spring makes the cylinder rod return.

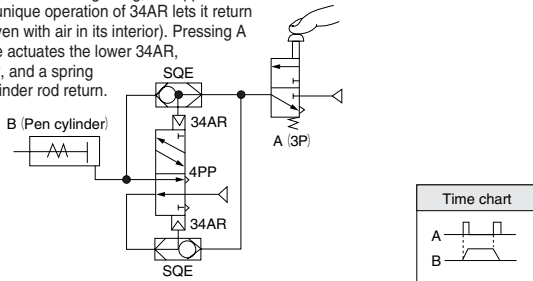

12. Sequential operation of 2 air cylinders

Actuating valve A extends cylinder B's rod (machines the workpiece), and then retracts the rod, after this, it extends cylinder C's rod (pushes the workpiece), and then retracts the rod.

Note—When cylinder B's rod has returned prior to the start, valve D gives an air pressure signal from 3P so that it prevents cylinder C's rod from extending. After cylinder B's rod starts and extends, valve D has been already switched and it can extend cylinder C's rod.

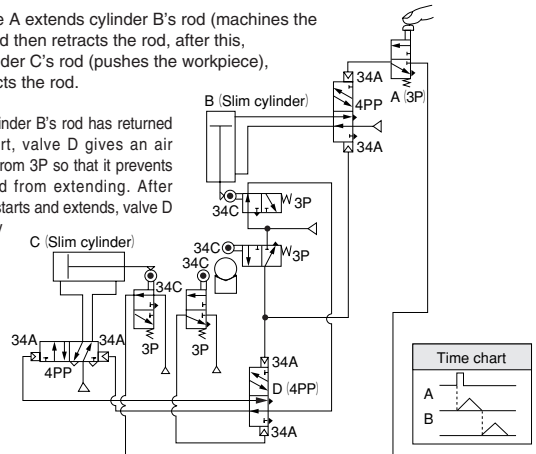



Types and operating force of operators (valve operation devices)

Combines with the basic valves to create valves for all kinds of operation types.

Note: Always insert a spacer of 2~2.5mm [0.079~0.098in.] between the basic valve and the operator. The lock nut (1 pc. nut) supplied with the basic valve can be used as a spacer.

The mounting brackets shared with the one of TAC air valve range can also be used as spacers.

| | | Model 34A Air pilot operator | Model 341A Air pilot operator | Model 34AL Air pilot operator for low pressure | |
|--------------------------|-----------|---|---|---|-------------|
| | |  |  |  | |
| Pilot pressure (minimum) | | MPa [psi.] | | | |
| | | Basic valve | 31P | 41P | 41PP |
| Main pressure MPa [psi.] | 0.1 [15] | 34A | 0.30 [44] | 0.46 [67] | 0.13 [19] |
| | | 341A | 0.18 [26] | 0.29 [42] | 0.09 [13] |
| | | 34AL | 0.07 [10] | 0.09 [13] | 0.04 [6] |
| | 0.3 [44] | 34A | 0.34 [49] | 0.48 [70] | 0.14 [20] |
| | | 341A | 0.20 [29] | 0.30 [44] | 0.11 [16] |
| | | 34AL | 0.07 [10] | 0.10 [15] | 0.05 [7] |
| | 0.5 [73] | 34A | 0.35 [51] | 0.50 [73] | 0.18 [26] |
| | | 341A | 0.22 [32] | 0.31 [45] | 0.13 [19] |
| | | 34AL | 0.08 [12] | 0.10 [15] | 0.05 [7] |
| | 0.7 [102] | 34A | 0.39 [57] | 0.52 [75] | 0.21 [30] |
| | | 341A | 0.25 [36] | 0.33 [48] | 0.15 [22] |
| | | 34AL | 0.09 [13] | 0.11 [16] | 0.06 [87] |

Note: Use the 34A when a high pilot pressure can be obtained.

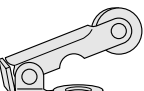
| | | Model 34B Ball-cam operator | Model 34C Roller-cam operator | | |
|---------------------------|-----------|---|---|-------------|-------------|
| | |  |  | | |
| | | Pre-stroke | 1.6mm [0.063in.] | | |
| | | Main stroke | 1.6mm [0.063in.] | | |
| | | Over stroke | 1.6mm [0.063in.] | | |
| | | Note: Completely switches at a stroke of 3.2mm or larger. Do not use a stroke of 4.8mm or larger. | | | |
| Operating force (minimum) | | N [lbf.] | | | |
| | | Basic valve | 31P | 41P | 41PP |
| Main pressure MPa [psi.] | 0.1 [15] | 34B | 26.5 [5.96] | 37.3 [8.39] | 9.8 [2.20] |
| | | 34C | 17.7 [3.98] | 26.5 [5.96] | 5.9 [1.33] |
| | 0.3 [44] | 34B | 27.5 [6.18] | 38.2 [8.59] | 11.8 [2.65] |
| | | 34C | 18.6 [4.18] | 27.5 [6.18] | 6.9 [1.55] |
| | 0.5 [73] | 34B | 29.4 [6.61] | 41.2 [9.26] | 12.7 [2.85] |
| | | 34C | 20.6 [4.63] | 27.5 [6.18] | 7.8 [1.75] |
| | 0.7 [102] | 34B | 32.4 [7.28] | 44.1 [9.91] | 16.7 [3.75] |
| | | 34C | 23.5 [5.28] | 29.4 [6.61] | 9.8 [2.20] |

| | | Model 34AR Self return type Air pilot operator | | |
|--------------------------|-----------|---|------------|-------------|
| | |  | | |
| Pilot pressure (minimum) | | MPa [psi.] | | |
| | | Basic valve | | |
| Main pressure | | 31P | 41P | 41PP |
| Main pressure MPa [psi.] | 0.1 [15] | 0.32 [46] | 0.33 [48] | 0.25 [36] |
| | 0.3 [44] | 0.34 [49] | 0.34 [49] | 0.25 [36] |
| | 0.5 [73] | 0.36 [52] | 0.36 [52] | 0.25 [36] |
| | 0.7 [102] | 0.39 [57] | 0.39 [57] | 0.25 [36] |

This operator actuates immediately after receiving pilot pressure, but then returns immediately after that. When used in combination with 4PP and 41PP, it can also be used with other operators, for separate actuation from the 34AR.
See p.847 for an explanation.

Note: The following operators cannot be used with the TAC2:

- 34AS (snap-action type air pilot operator) — Because of its strong operating force.
- 34F (foot, elbow, and hand operated operator) — Because of the piping port location.

Hand wrench

Can be used for all fittings, valves, and lock nuts. Use of 2 pieces is convenient and recommended.

●151-20

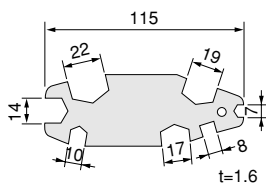

Bracket

Used for mounting valves and regulators in the TAC air valve series. Slot A is for piping, while Slot B is for mounting screws.

●8-60

Flat

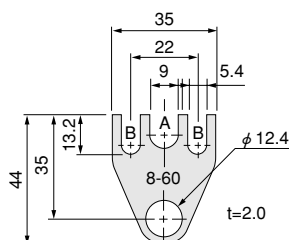

●8-600

Angle

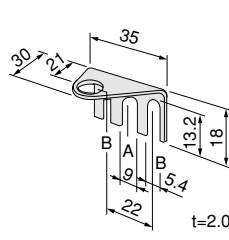

●8-70

Multiple-use

