

Eliminate Dead Space

KOGANEI TWINPORT CYLINDERS

Twinport

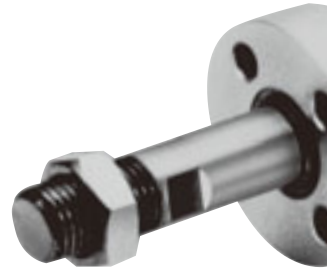

Two connection ports are positioned on one side to eliminate dead space from the area around the cylinder. Air cylinder works with compact, highly rigid mounts to achieve space-saving and smaller pitch mountings.

Positioning connection ports on the single plane on the rod side or the head side cuts piping space in half and also eliminates the need to take special considerations for adjusting space for the speed controller. Compact, highly rigid mounting design achieves smaller pitch and highly accurate mountings for twinport cylinders, and also lets the connection ports be freely selected at 90° intervals. The twinport cylinders are developed for space-saving, flexible design suited to the design, assembly, and maintenance of mechanical devices.

Comparison with conventional cylinders (Cylinder space)

	-HA : Head side piping	-RA : Rod side piping
Twinport cylinders		
Conventional cylinders		

(Mounting pitch) For $\phi 20$

	Foot mounting type	Flange mounting type
Twinport cylinders	To 50%	To 75%
Conventional cylinders		

Basic Type and Configurations

-HA Head Side Piping Type

This system makes it possible to fully utilize the space around the piston rod. And use of the piping adapter: -L lets the piping direction to the cylinder center line be changed perpendicularly at right angles. There are 3 mounting types available, including the basic type, the single foot mounting type, and the flange mounting type.

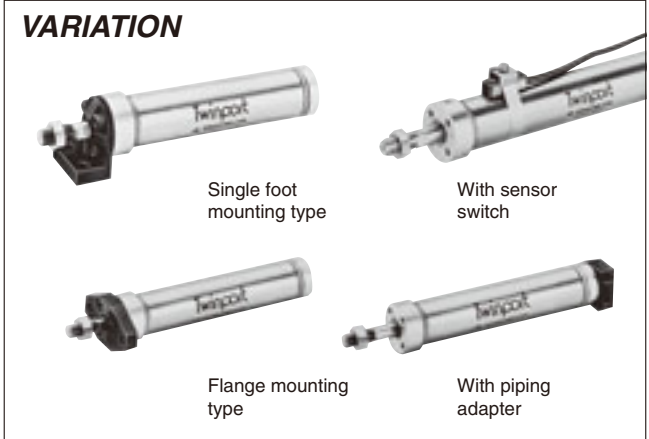

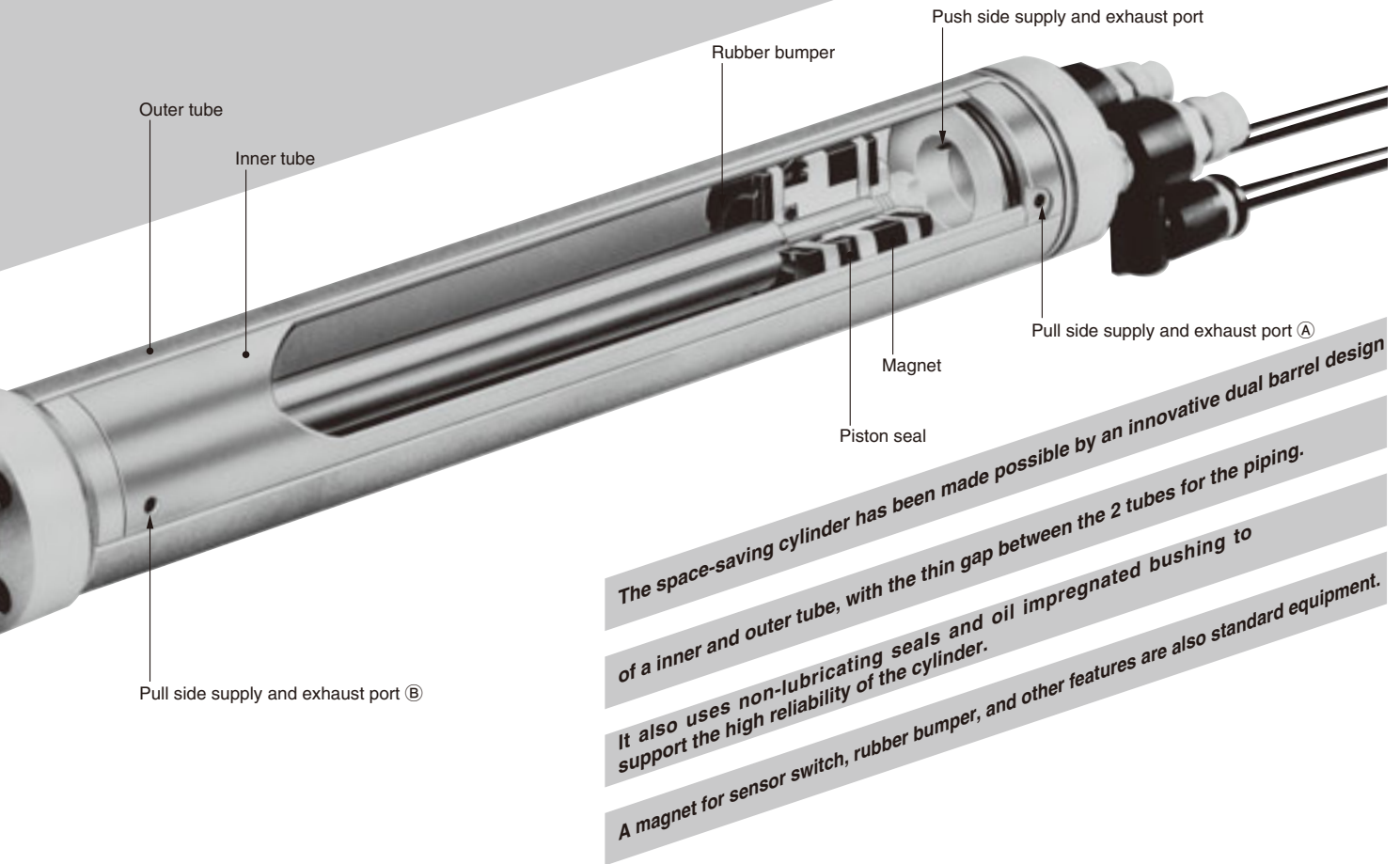

-RA Rod Side Piping Type

Integrating connection ports on the piston rod side is optimum for saving space on the head side. There are 4 mounting types available, including the basic type, the single foot mounting type, the double foot mounting type, and the flange mounting type.

-RA Rod side piping type



VARIATION

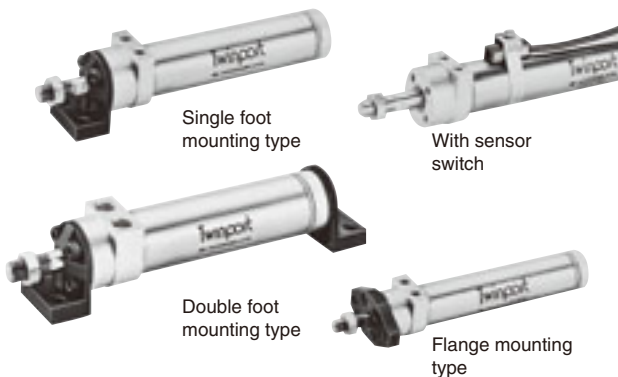

-RB Rod Side Piping Block Type

Both the connection port and the mounting section are located on the rod side. Another connection port is also on the side surface of the block, mounting the connection port to face the mechanical devices' piping port surface enables direct piping without using any fittings.

-RB Rod side piping block type

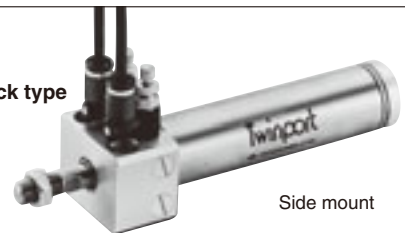

VARIATION



TWINPORT CYLINDERS

Head Side Piping, Rod Side Piping

※ For cylinder thrust, air consumption and air flow rate, see p.435~436.

Symbol



1 : Pull side connection port
2 : Push side connection port

Specifications

Item	Bore size mm [in.]	16 [0.630]	20 [0.787]	25 [0.984]	32 [1.260]	40 [1.575]
Operation type		Double acting type				
Media		Air				
Mounting type		Basic type, Single foot type, Double foot type, Flange type, Side mount				
Operating pressure range MPa [psi.]		0.1~0.7 [15~102]				
Proof pressure MPa [psi.]		1.03 [149]				
Operating temperature range °C [°F]		0~60 [32~140]				
Operating speed range mm/s [in./sec.]		50~500 [2.0~19.7]				
Cushion		Fixed type (Rubber bumper)				
Lubrication		Not required				
Port size		M5×0.8		Rc1/8		

Bore Size and Stroke

Bore size	Standard strokes	mm	
		Maximum stroke	Maximum available stroke
16	15, 25, 50, 75, 100	100	300
20	15, 25, 50, 75, 100, 150	150	500
25	15, 25, 50, 75, 100, 150, 200	200	500
32	15, 25, 50, 75, 100, 150, 200	200	500
40	15, 25, 50, 75, 100, 150, 200, 250, 300	300	500

Remark: Stroke tolerance $+1 \left[+0.039 \text{in.} \right]$

Connection Port Location and Mounting Type

Connection port location	Mounting type
Head side piping : -HA	Basic type, Single foot type, and Flange type
Rod side piping : -RA	Basic type, Single foot type, Double foot type, and Flange type
Rod side piping block type : -RB	Side mount

Order Codes

TWDA 20×50 - [] - [] - [] - [] - [] - [] - [] - []

Bore size × Stroke

Twinport cylinder

Non-ion specification
Blank — Standard
NCU — Non-ion specification

Connection port location
HA — Head side piping
RA — Rod side piping
RB — Rod side piping block type

Mounting type
(Head side piping: **-HA**, Rod side piping: **-RA** only)
Blank — Basic type
1A — Single foot mounting type
1B — Double foot mounting type (Rod side piping: **-RA** only)
3A — Flange mounting type
● Mounting brackets are included at shipping.

Piping adapter (Head side piping: **-HA** only)
Blank — No piping adapter
L — With piping adapter
● Piping adapters are included at shipping.

Lead wire length
A — 1000mm [39 in.]
B — 3000mm [118 in.]

Number of sensor switches
1 — With 1 sensor switch
2 — With 2 sensor switches
3 — With 3 sensor switches

Sensor switch
Blank — No sensor switch
ZG530 — Solid state type 2-lead wire with indicator lamp DC10~28V
ZG553 — Solid state type 3-lead wire with indicator lamp DC4.5~28V
CS3M — Reed switch type 2-lead wire with indicator lamp DC10~30V AC85~230V
CS4M — Reed switch type 2-lead wire with indicator lamp DC10~30V AC85~115V
CS5M — Reed switch type 2-lead wire without indicator lamp DC3~30V AC85~115V
● For details of sensor switches, see p.1544.

Rod end accessory
Blank — No knuckle
I — I type knuckle
Y — Y type knuckle (with pin)
● For the cylinder joint and cylinder rod end, see p.1568.

Inner Construction and Major Parts

The diagram is for the head side piping: **-HA**

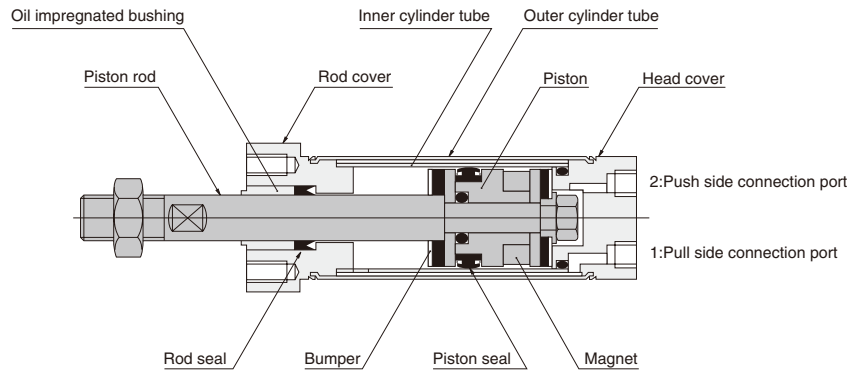

TWINPORT CYLINDERS

Major Parts and Materials

Parts	Bore size mm				
	16	20	25	32	40
Outer cylinder tube	Stainless steel				
Inner cylinder tube	Brass ^{Note}				
Piston	Plastic				
Piston rod	Stainless steel (Hard chrome plated)		Steel (Hard chrome plated)		
Rod cover	Aluminum (Anodized)				
Head cover					
Seal	Synthetic rubber (NBR)				
Bumper					
Magnet	Rubber magnet	Plastic magnet			
Piping adapter	Aluminum (Black anodized)				
Rod nut	Mild steel				
I type, Y type knuckle	Mild steel (Zinc plated; nickel plated for φ 16.)				

Note: The non-ion specification's inner cylinder tube is stainless steel, while the oil impregnated bronze bushing is changed to an oil impregnated plastic bushing.

Seals

Parts	Rod seal	Piston seal
Bore size mm	Quantity	Quantity
16	1	1
20	1	1
25	1	1
32	1	1
40	1	1

Mass

Connection port location	Bore size mm [in.]	Zero stroke mass Basic type	Additional mass for each 1mm [0.0394in.] stroke	Additional mass					
				Single foot mounting type	Double foot mounting type	Flange mounting type	With piping adapter	I type knuckle	Y type knuckle
Head side piping : -HA	16 [0.630]	0.060 [0.132]	0.0008 [0.0018]	0.028 [0.062]	-	0.030 [0.066]	0.008 [0.018]	0.022 [0.049]	0.015 [0.033]
	20 [0.787]	0.110 [0.243]	0.0012 [0.0026]	0.050 [0.110]		0.054 [0.119]	0.013 [0.029]	0.036 [0.079]	0.041 [0.090]
	25 [0.984]	0.165 [0.364]	0.0016 [0.0035]	0.070 [0.154]		0.076 [0.168]	0.030 [0.066]	0.070 [0.154]	0.075 [0.165]
	32 [1.260]	0.275 [0.606]	0.0023 [0.0051]	0.105 [0.232]		0.135 [0.298]	0.060 [0.132]	0.070 [0.154]	0.075 [0.165]
	40 [1.575]	0.485 [1.069]	0.0033 [0.0073]	0.185 [0.408]		0.235 [0.518]	0.095 [0.209]	0.132 [0.291]	0.120 [0.265]
Rod side piping : -RA	16 [0.630]	0.075 [0.165]	0.0008 [0.0018]	0.028 [0.062]	0.055 [0.121]	0.030 [0.066]	-	-	-
	20 [0.787]	0.130 [0.287]	0.0012 [0.0026]	0.050 [0.110]	0.098 [0.216]	0.054 [0.119]			
	25 [0.984]	0.210 [0.463]	0.0016 [0.0035]	0.070 [0.154]	0.140 [0.309]	0.076 [0.168]			
	32 [1.260]	0.365 [0.805]	0.0023 [0.0051]	0.105 [0.232]	0.205 [0.452]	0.135 [0.298]			
	40 [1.575]	0.650 [1.433]	0.0033 [0.0073]	0.185 [0.408]	0.355 [0.783]	0.235 [0.518]			
Rod side piping Block type : -RB	16 [0.630]	0.090 [0.198]	0.0008 [0.0018]	-	-	-	-	-	-
	20 [0.787]	0.155 [0.342]	0.0012 [0.0026]						
	25 [0.984]	0.245 [0.540]	0.0016 [0.0035]						
	32 [1.260]	0.430 [0.948]	0.0023 [0.0051]						
	40 [1.575]	0.775 [1.709]	0.0033 [0.0073]						

Calculation example: For head side piping: **-HA** single foot mounting type of 20mm bore size and 50mm stroke, with piping adapter, $0.110 + (0.0012 \times 50) + 0.050 + 0.013 = 0.233\text{kg}$ [0.514 lb.]

-HA Dimensions of Head Side Piping Type (mm)

● Basic type TWDA × -HA

 TWDA HA

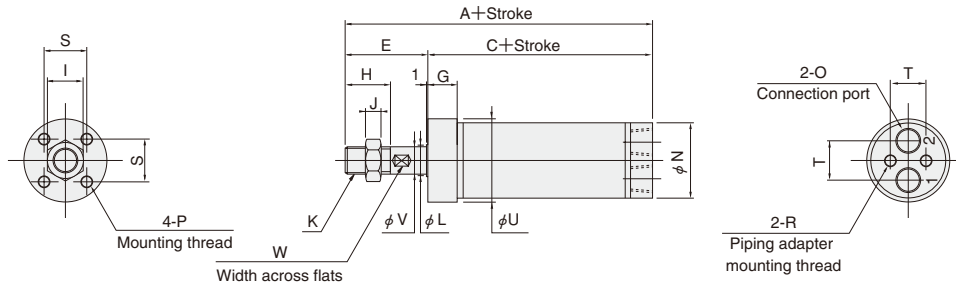

● Single foot mounting type TWDA × -HA-1A

 TWDA HA
TWDA-1A

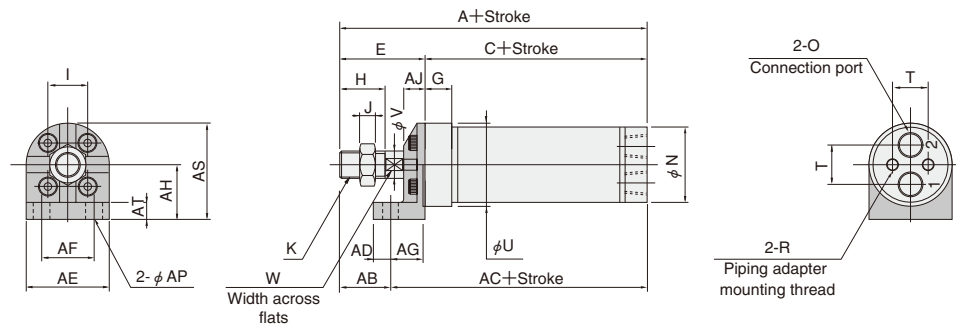

Bore mm [in.]	Code	A	C	E	G	H	I	J	K	L	N	O	P	R	S	T	U	V	W
16	[0.630]	77	51	26	8	15	10	5	M6×1	8 _{-0.05} ⁰	19	M5×0.8	M3×0.5 Depth5.5	M3×0.5 Depth6	12	11	22	6	—
20	[0.787]	89	58	31	10	15	12	5	M8×1	10 _{-0.05} ⁰	23.6	M5×0.8	M4×0.7 Depth7.5	M4×0.7 Depth6	14	13	28	8	6
25	[0.984]	96	62	34	10	18	14	6	M10×1.25	12 _{-0.05} ⁰	28.8	Rc1/8	M5×0.8 Depth7.5	M4×0.7 Depth6	16	15	32	10	8
32	[1.260]	107	68	39	10	23	14	6	M10×1.25	15 _{-0.05} ⁰	36.4	Rc1/8	M5×0.8 Depth7.5	M5×0.8 Depth7	20	20	40	12	10
40	[1.575]	117	77	40	12	23	19	8	M14×1.5	20 _{-0.05} ⁰	44.6	Rc1/8	M6×1 Depth9.5	M5×0.8 Depth7	26	26	50	16	14

Bore mm [in.]	Code	AB	AC	AD	AE	AF	AG	AH	AJ	AP	AS	AT
16	[0.630]	15	62	4	22	14	10	16	7	4.5	27	6
20	[0.787]	18	71	5	28	18	12	19	8	5.5	33	7
25	[0.984]	19	77	6	32	20	14	21	9	6.5	37	8
32	[1.260]	24	83	6	40	28	14	25	9	6.5	45	8
40	[1.575]	21	96	8	50	34	18	30	10	9	55	9

● Flange mounting type

φ 16 ~ φ 25 TWDA Bore size × Stroke -HA-3A

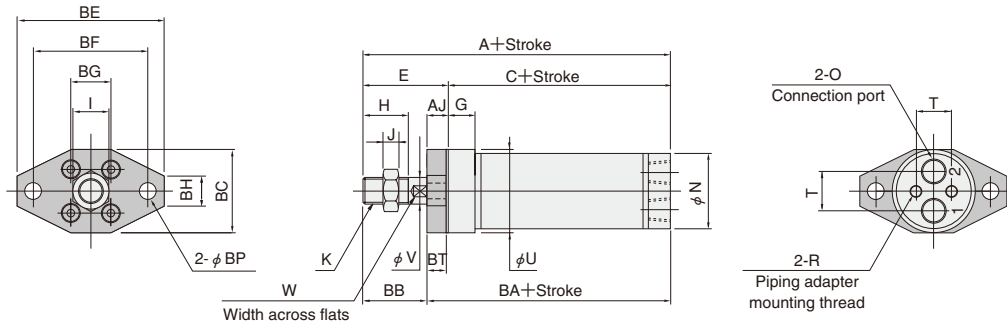

φ 32, φ 40 TWDA Bore size × Stroke -HA-3A

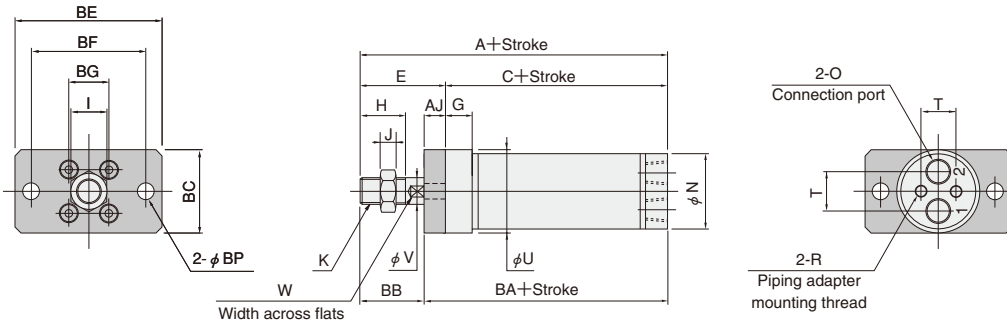

With piping adapter TWDA Bore size × Stroke -HA-L

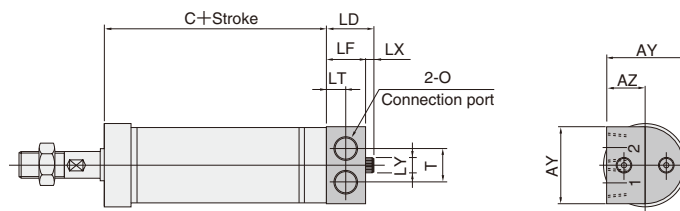

Bore mm [in.]	Code	A	C	E	G	H	I	J	K	N	O	R	T	U	V	W
16	[0.630]	77	51	26	8	15	10	5	M6×1	19	M5×0.8	M3×0.5 Depth6	11	22	6	—
20	[0.787]	89	58	31	10	15	12	5	M8×1	23.6	M5×0.8	M4×0.7 Depth6	13	28	8	6
25	[0.984]	96	62	34	10	18	14	6	M10×1.25	28.8	Rc1/8	M4×0.7 Depth6	15	32	10	8
32	[1.260]	107	68	39	10	23	14	6	M10×1.25	36.4	Rc1/8	M5×0.8 Depth7	20	40	12	10
40	[1.575]	117	77	40	12	23	19	8	M14×1.5	44.6	Rc1/8	M5×0.8 Depth7	26	50	16	14

Bore mm [in.]	Code	AJ	AY	AZ	BA	BB	BC	BE	BF	BG	BH	BP	BT	LD	LF	LT	LX	LY
16	[0.630]	7	20	10	58	19	22	40	32	12	8	4.5	6	9	8	4	1	5.5
20	[0.787]	8	24.6	12.3	66	23	28	50	40	14	10	5.5	7	10	8	4	2	7
25	[0.984]	9	29.8	14.9	71	25	32	56	44	16	12	6.5	8	19	16	8	3	7
32	[1.260]	9	41	20.5	77	30	40	66	54	20	—	6.5	—	19	16	8	3	8.5
40	[1.575]	10	51	25.5	87	30	50	84	68	26	—	9	—	19	16	8	3	8.5

-RA Dimensions of Rod Side Piping Type (mm)

● Basic type TWDA × -RA

 TWDA RA

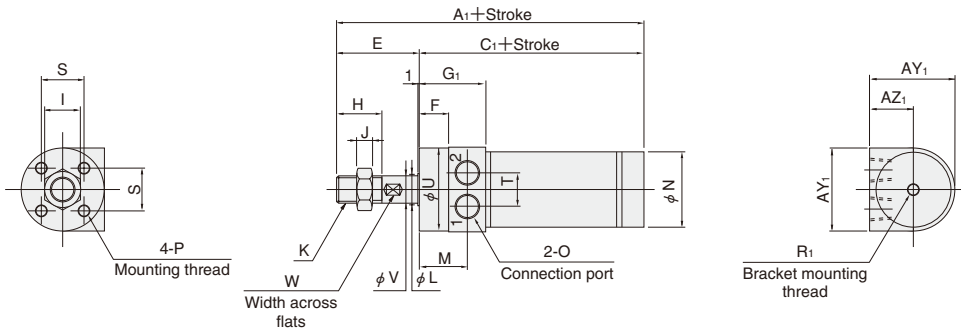

● Single foot mounting type TWDA × -RA-1A

 TWDA RA
TWDA-1A

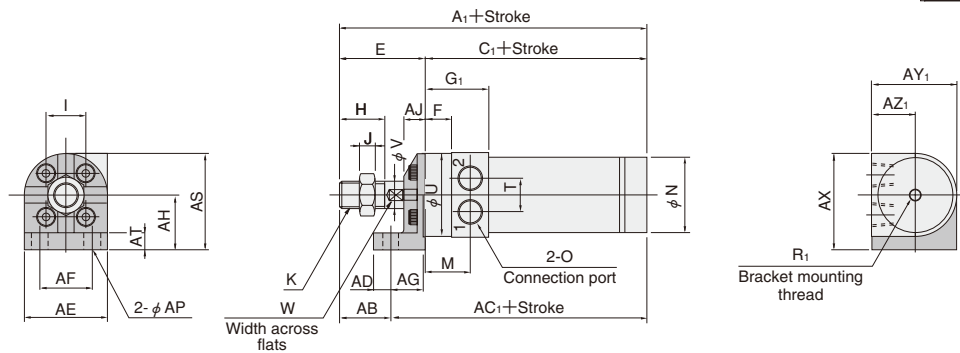

● Double foot mounting type TWDA × -RA-1B

 TWDA RA
TWDA-1B1
TWDA-1B2

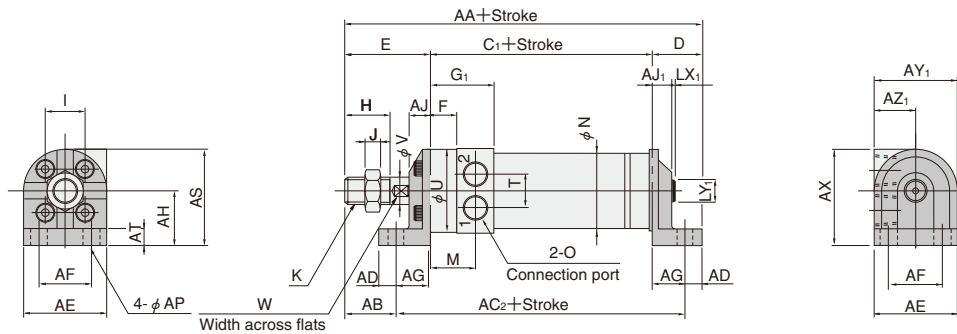

Bore mm [in.]	Code	A ₁	C ₁	D	E	F	G ₁	H	I	J	K	L	M	N	O	P	R ₁	S	T	U	V	W
16	[0.630]	87	61	14	26	10	18	15	10	5	M6×1	8 ⁰ _{-0.05}	14	19	M5×0.8	M3×0.5 Depth5.5	M3×0.5 Depth6	12	11	22	6	—
20	[0.787]	99	68	17	31	12	20	15	12	5	M8×1	10 ⁰ _{-0.05}	16	23.6	M5×0.8	M4×0.7 Depth7.5	M4×0.7 Depth6	14	13	28	8	6
25	[0.984]	111	77	20	34	11	25	18	14	6	M10×1.25	12 ⁰ _{-0.05}	18	28.8	Rc1/8	M5×0.8 Depth7.5	M5×0.8 Depth7	16	15	32	10	8
32	[1.260]	127	88	20	39	16	30	23	14	6	M10×1.25	15 ⁰ _{-0.05}	23	36.4	Rc1/8	M5×0.8 Depth7.5	M5×0.8 Depth7	20	20	40	12	10
40	[1.575]	142	102	26	40	23	37	23	19	8	M14×1.5	20 ⁰ _{-0.05}	30	44.6	Rc1/8	M6×1 Depth9.5	M6×1 Depth9	26	26	50	16	14

Bore mm [in.]	Code	AA	AB	AC ₁	AC ₂	AD	AE	AF	AG	AH	AJ	AJ ₁	AP	AS	AT	AX	AY ₁	AZ ₁	LX ₁	LY ₁
16	[0.630]	101	15	72	82	4	22	14	10	16	7	6	4.5	27	6	27.5	23	11.5	—	—
20	[0.787]	116	18	81	93	5	28	18	12	19	8	7	5.5	33	7	33.5	29	14.5	2	7
25	[0.984]	131	19	92	106	6	32	20	14	21	9	8	6.5	37	8	37.5	33	16.5	1	8.5
32	[1.260]	147	24	103	117	6	40	28	14	25	9	8	6.5	45	8	45.5	41	20.5	1	8.5
40	[1.575]	168	21	121	139	8	50	34	18	30	10	9	9	55	9	55.5	51	25.5	1	10

● Flange mounting type

φ 16 ~ φ 25 TWDA [Bore size] × [Stroke] -RA-3A

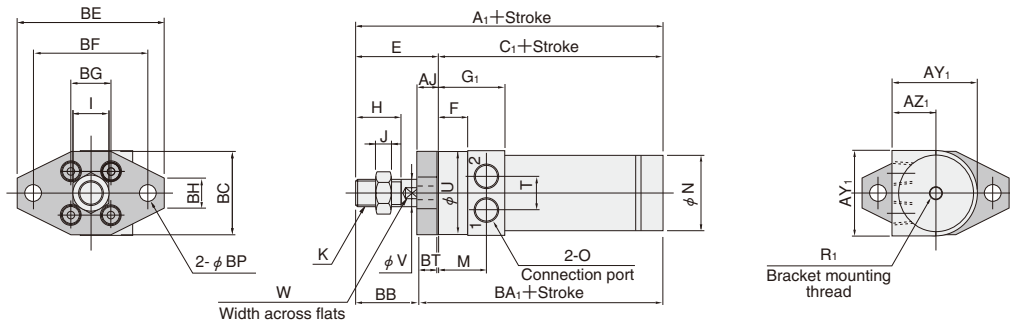
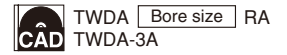

φ 32, φ 40 TWDA [Bore size] × [Stroke] -RA-3A

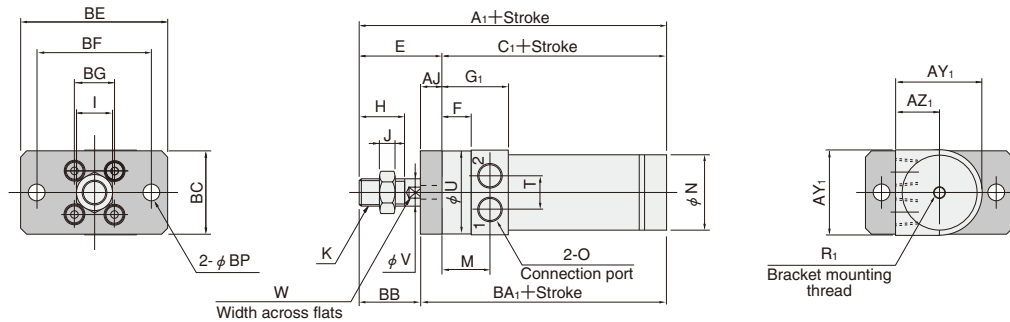

TWINPORT CYLINDERS

Bore mm [in.]	Code	A ₁	C ₁	E	F	G ₁	H	I	J	K	M	N	O	R ₁	T	U	V	W
16	[0.630]	87	61	26	10	18	15	10	5	M6×1	14	19	M5×0.8	M3×0.5 Depth6	11	22	6	—
20	[0.787]	99	68	31	12	20	15	12	5	M8×1	16	23.6	M5×0.8	M4×0.7 Depth6	13	28	8	6
25	[0.984]	111	77	34	11	25	18	14	6	M10×1.25	18	28.8	Rc1/8	M5×0.8 Depth7	15	32	10	8
32	[1.260]	127	88	39	16	30	23	14	6	M10×1.25	23	36.4	Rc1/8	M5×0.8 Depth7	20	40	12	10
40	[1.575]	142	102	40	23	37	23	19	8	M14×1.5	30	44.6	Rc1/8	M6×1 Depth9	26	50	16	14

Bore mm [in.]	Code	A _J	A _{Y1}	A _{Z1}	B _{A1}	B _B	B _C	B _E	B _F	B _G	B _H	B _P	B _T
16	[0.630]	7	23	11.5	68	19	22	40	32	12	8	4.5	6
20	[0.787]	8	29	14.5	76	23	28	50	40	14	10	5.5	7
25	[0.984]	9	33	16.5	86	25	32	56	44	16	12	6.5	8
32	[1.260]	9	41	20.5	97	30	40	66	54	20	—	6.5	—
40	[1.575]	10	51	25.5	112	30	50	84	68	26	—	9	—

-RB Dimensions of Rod Side Piping Block Type (mm)

● Side mount TWDA Bore size × Stroke -RB

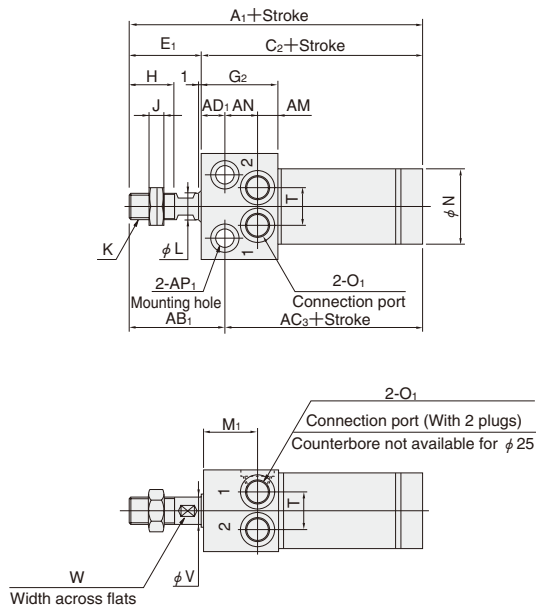
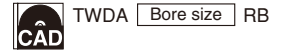

Code	A ₁	C ₂	E ₁	G ₂	H	I	J	K	L	M ₁	N	O ₁	T	V	W	AB ₁	AC ₃	AD ₁	AE ₁	AF ₁	AH ₁	AM	AN	AP ₁	AS ₁
16 [0.630]	87	64	23	21	15	10	5	M6×1	8 ⁰ _{-0.05}	15	19	M5×0.8 Counterbore φ 8.4 Depth 1.8	11	6	—	28	59	5	30	16	12	6	10	φ 4.5 C'bore φ 8 Depth 4.5	24
20 [0.787]	99	72	27	24	15	12	5	M8×1	10 ⁰ _{-0.05}	18	23.6	M5×0.8 Counterbore φ 8.4 Depth 1.8	13	8	6	34	65	7	38	22	14	6	11	φ 6.6 C'bore φ 11 Depth 6.5	28
25 [0.984]	111	82	29	30	18	14	6	M10×1.25	12 ⁰ _{-0.05}	22	28.8	Rc1/8 Counterbore φ 13.4 Depth 1.8	15	10	8	38	73	9	42	26	15	8	13	φ 6.6 C'bore φ 11 Depth 6.5	30
32 [1.260]	127	94	33	36	23	14	6	M10×1.25	15 ⁰ _{-0.05}	28	36.4	Rc1/8 Counterbore φ 13.4 Depth 1.8	20	12	10	45	82	12	54	34	19	8	16	φ 9 C'bore φ 14 Depth 8.6	38
40 [1.575]	142	109	33	44	23	19	8	M14×1.5	20 ⁰ _{-0.05}	36	44.6	Rc1/8 Counterbore φ 13.4 Depth 1.8	26	16	14	48	94	15	68	46	23	8	21	φ 11 C'bore φ 17.5 Depth 10.8	46

Dimensions of Rod End Accessories (mm)

● Y type
for φ 16 [0.630 in.]

● I type
for φ 16 [0.630 in.]

● Y type for φ 20 [0.787 in.]
~ φ 40 [1.575 in.]

● I type for φ 20 [0.787 in.]
~ φ 40 [1.575 in.]

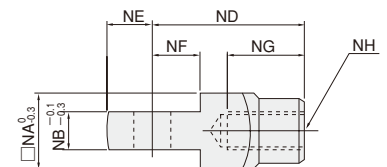
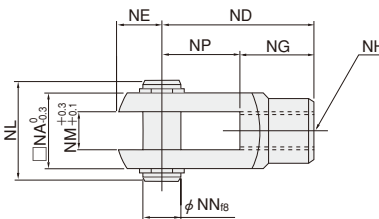
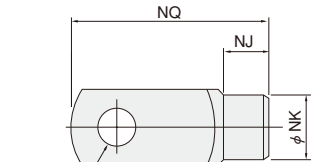
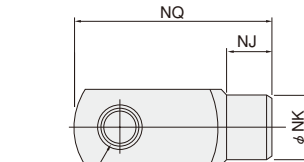
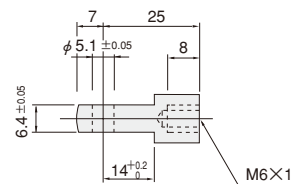
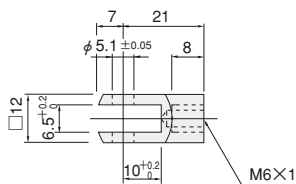
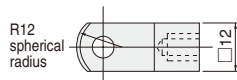
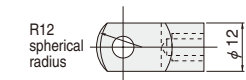

Pin bracket for Y type knuckle

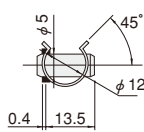
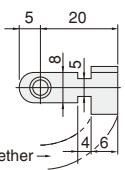

Fit together

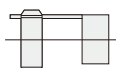

Code	NA	NB	NC	ND	NE	NF	NG	NH	NJ	NK	NL	NM	NN	NP	NQ
20 [0.787]	16	8	8	30	10	11	15	M8×1	10	14	21	8	8	15	40
25, 32 [0.984, 1.260]	19	10	10	40	12	13	20	M10×1.25	12	16	25	10	10	20	52
40 [1.575]	24	14	10	45	12	13	25	M14×1.5	15	22	30	14	10	20	57

SENSOR SWITCHES

Order Codes for Sensor Switches

● Sensor switches (with mounting strap)

				Sensor switch model	Lead wire length	Cylinder basic type	Bore size
Solid state type	2-lead wire	With indicator lamp	DC10~28V	ZG530	A B	-TWDA	16 20 25 32 40
Solid state type	3-lead wire	With indicator lamp	DC4.5~28V	ZG553			
Reed switch type	2-lead wire	With indicator lamp	DC10~30V AC85~230V	CS3M			
Reed switch type	2-lead wire	With indicator lamp	DC10~30V AC85~115V	CS4M			
Reed switch type	2-lead wire	Without indicator lamp	DC3~30V AC85~115V	CS5M			

Remark: For details of sensor switches, see p.1544.

- A : 1000mm [39 in.]
- B : 3000mm [118 in.]

● Order codes for mounting straps only

G5- TWDA □

Bore size
 16 : For ϕ 16
 20 : For ϕ 20
 25 : For ϕ 25
 32 : For ϕ 32
 40 : For ϕ 40

Cylinder basic type

Sensor switch type
 G5: For solid state type sensor switches (ZG5□□)
 For reed switch type sensor switches (CS□M)

TWINPORT CYLINDERS

Sensor Switch Operating Range, Response Differential, and Maximum Sensing Location

For ZG5□□□ and CS□M□ types

- Operating range : ℓ
 The distance the piston travels in one direction, while the switch is in the ON position.
- Response differential: C
 The distance between the point where the piston turns the switch ON and the point where the switch is turned OFF as the piston travels in the opposite direction.

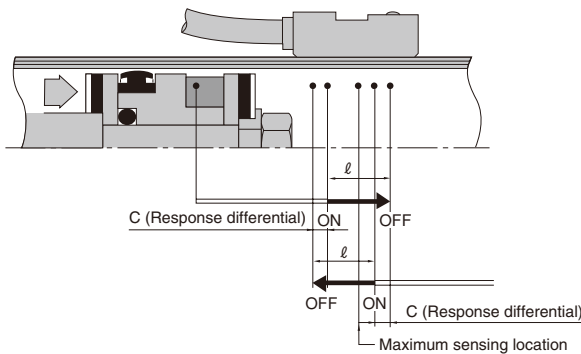

Bore size mm [in.]	ZG530□, ZG553□			CS□M□		
	Operating range	Response differential	Maximum sensing location ^{Note}	Operating range	Response differential	Maximum sensing location ^{Note}
16 [0.630]	2.7~4.5 [0.106~0.177]	0.7 [0.028] or less	11 [0.433]	7.0~9.0 [0.276~0.354]	2.0 [0.079] or less	11 [0.433]
20 [0.787]	2.8~4.7 [0.110~0.185]			8.5~10.5 [0.335~0.413]		
25 [0.984]	2.7~4.5 [0.106~0.177]	7.0~8.5 [0.276~0.335]				
32 [1.260]	3.0~5.1 [0.118~0.201]	8.0~10.0 [0.315~0.394]				
40 [1.575]	3.3~5.5 [0.130~0.217]	0.8 [0.031] or less	9.5~11.0 [0.374~0.433]			

Remark: The above table shows reference values.

Note: This is the length measured from the switch's opposite end side to the lead wire.

Moving Sensor Switch

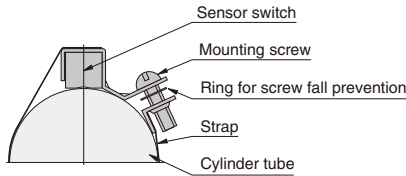

- Loosening the mounting screw allows the sensor switch to be moved freely along with the strap in the axial and circumferential direction. The sensor switch alone cannot be moved.
- To remove the sensor switch from the strap, first detach the strap from the cylinder tube and then remove the sensor switch from the strap.
- Tighten the mounting screw with a tightening torque of 49N·cm [4.3in·lbf] or less.

Mounting Location of Sensor Switch

When the piston reaches the end of the stroke with the sensor switch installed in the location shown in the diagram, the magnet mounted on the piston comes to the sensor switch's maximum sensing location.

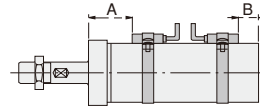

Bore size mm [in.]	ZG5□□□, CS□M□	
	A	B
16 [0.630]	9 [0.354]	8 [0.315] (16 [0.630])
20 [0.787]	12 [0.472]	9 [0.354] (17 [0.669])
25 [0.984]	14 [0.551]	11 [0.433] (27 [1.063])
32 [1.260]	17 [0.669]	13 [0.512] (29 [1.142])
40 [1.575]	20 [0.787]	17 [0.669] (33 [1.299])

Remarks 1: The value is the same regardless of the connection port location.

2: Figure in parentheses () are for the distance from the piping adapter end surface, for the case of piping adapter: -L.

Dimensions of Sensor Switch

For ZG5□□□ and CS□M□ types

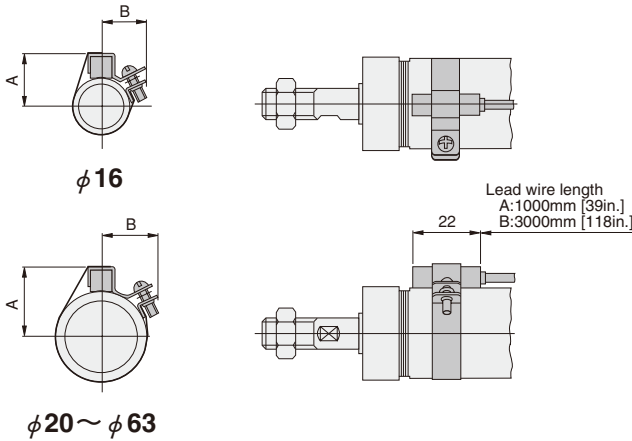

Bore mm [in.]	Code	mm [in.]	
		A	B
16 [0.630]		17 [0.669]	15 [0.591]
20 [0.787]		19.5 [0.768]	17.5 [0.689]
25 [0.984]		22.5 [0.886]	18 [0.709]
32 [1.260]		27 [1.063]	19.5 [0.768]
40 [1.575]		30 [1.181]	—*

※ When used on φ 40, dimension B is the radius of the cylinder tube's outer diameter. Therefore, there is no protrusion in the B direction of the mounting portion.

Cylinder Thrust

Bore size mm [in.]	Rod dia. mm [in.]	Operation type	Pressure area mm ² [in. ²]	Air pressure MPa [psi.]							
				0.1 [15]	0.2 [29]	0.3 [44]	0.4 [58]	0.5 [73]	0.6 [87]	0.7 [102]	
16 [0.630]	6 [0.236]	Double acting type	Push side	201 [0.312]	20.1 [4.52]	40.2 [9.04]	60.3 [13.56]	80.4 [18.07]	100.5 [22.59]	120.6 [27.11]	140.7 [31.63]
			Pull side	172 [0.267]	17.2 [3.87]	34.4 [7.73]	51.6 [11.60]	68.8 [15.47]	86.0 [19.33]	103.2 [23.20]	120.4 [27.07]
20 [0.787]	8 [0.315]	Double acting type	Push side	314 [0.487]	31.4 [7.06]	62.8 [14.12]	94.2 [21.18]	125.6 [28.23]	157.0 [35.29]	188.4 [42.35]	219.8 [49.41]
			Pull side	264 [0.409]	26.4 [5.93]	52.8 [11.87]	79.2 [17.80]	105.6 [23.74]	132.0 [29.67]	158.4 [35.61]	184.8 [41.54]
25 [0.984]	10 [0.394]	Double acting type	Push side	490 [0.760]	49.0 [11.02]	98.0 [22.03]	147.0 [33.05]	196.0 [44.06]	245.0 [55.08]	294.0 [66.09]	343.0 [77.11]
			Pull side	412 [0.639]	41.2 [9.26]	82.4 [18.52]	123.6 [27.79]	164.8 [37.05]	206.0 [46.31]	247.2 [55.57]	288.4 [64.83]
32 [1.260]	12 [0.472]	Double acting type	Push side	804 [1.246]	80.4 [18.07]	160.8 [36.15]	241.2 [54.22]	321.6 [72.30]	402.0 [90.37]	482.4 [108.44]	562.8 [126.52]
			Pull side	690 [1.070]	69.0 [15.51]	138.0 [31.02]	207.0 [46.53]	276.0 [62.04]	345.0 [77.56]	414.0 [93.07]	483.0 [108.58]
40 [1.575]	16 [0.630]	Double acting type	Push side	1256 [1.947]	125.6 [28.23]	251.2 [56.47]	376.8 [84.70]	502.4 [112.94]	628.0 [141.17]	753.6 [169.41]	879.2 [197.64]
			Pull side	1055 [1.635]	106.0 [23.83]	211.0 [47.43]	317.0 [71.26]	422.0 [94.87]	528.0 [118.69]	633.0 [142.30]	739.0 [166.13]

Air Consumption and Air Flow Rate

The figures in the table below show the air consumption when a Twinport Cylinder makes 1 reciprocation with stroke of 1mm [0.039in.]. The air flow rate and air consumption actually required is found by the calculation below.

Air consumption for each 1mm [0.039in.] stroke

cm³ [in.³]/reciprocation (ANR)

Bore size mm [in.]	Air pressure MPa [psi.]						
	0.1 [15]	0.2 [29]	0.3 [44]	0.4 [58]	0.5 [73]	0.6 [87]	0.7 [102]
16 [0.630]	0.79 [0.0482]	1.18 [0.0720]	1.57 [0.0958]	1.96 [0.1196]	2.35 [0.1434]	2.74 [0.1672]	3.13 [0.1910]
20 [0.787]	1.24 [0.0757]	1.86 [0.1135]	2.45 [0.1495]	3.07 [0.1873]	3.68 [0.2246]	4.29 [0.2618]	4.90 [0.2990]
25 [0.984]	1.94 [0.1184]	2.89 [0.1764]	3.83 [0.2337]	4.79 [0.2923]	5.75 [0.3509]	6.71 [0.4095]	7.67 [0.4681]
32 [1.260]	3.18 [0.1941]	4.73 [0.2886]	6.28 [0.3832]	7.85 [0.4790]	9.41 [0.5742]	10.98 [0.6700]	12.55 [0.7659]
40 [1.575]	4.95 [0.3021]	7.40 [0.4516]	9.83 [0.5999]	12.26 [0.7482]	14.69 [0.8964]	17.16 [1.047]	19.60 [1.196]

● Finding the air consumption

Example 1. When operating a Twinport Cylinder with bore size of 16mm and stroke of 50mm under air pressure of 0.5MPa

$$\underset{\substack{\text{From the table} \\ \text{Stroke}}}{2.35} \times \underset{\text{Stroke}}{50} \times 10^{-3} = 0.1175 \text{ l [7.17in.}^3\text{]}/\text{reciprocation (ANR)}$$

Example 2. When operating a Twinport Cylinder with bore size of 16mm and stroke of 50mm under air pressure of 0.5MPa, at rate of 20 reciprocations per minute

$$\underset{\substack{\text{From the table} \\ \text{Stroke}}}{2.35} \times \underset{\text{Stroke}}{50} \times \underset{\substack{\text{Operating frequency per minute} \\ \text{(reciprocation)}}}{20} \times 10^{-3} = 2.35 \text{ l [143in.}^3\text{]}/\text{min(ANR)}$$

● Finding the air flow rate (for selecting F.R.L., valves, etc.)

Example: When operating a Twinport Cylinder with bore size of 16mm at speed of 100mm/s under air pressure of 0.5MPa

$$\underset{\substack{\text{From the table} \\ \text{Speed mm/s}}}{2.35} \times \underset{\text{Speed mm/s}}{100} \times \frac{1}{2} \times 10^{-3} = 0.1175 \text{ l [7.17in.}^3\text{]}/\text{s (ANR)}$$

(The flow rate per minute at this time is 0.1175 × 60 = 7.05 l [430in.³]/min (ANR).)

Handling Instructions and Precautions



Mounting and piping

Mounting

- For the head side piping: **-HA**, use of a piping adapter (order code: **-L**) allows the piping direction to be changed at right-angles. To mount the piping adapter, attach the O-ring provided into the piping adapter's O-ring groove, and attach it on the cylinder.
- For the rod side piping block type: **-RB**, mounting the connection port to face the porting surface of the mechanical device and then mounting directly to the mechanical device without fittings and tubing achieve still more space-saving in piping. In this case, use the O-ring (P5 for ϕ 16 and 20, and P10 or equivalents for ϕ 25~40 [JIS B2401]) into the connection port's O-ring groove, and mount it on the mechanical device.

Piping

For Twinport cylinders, use the fittings and speed controllers in the table below.

- Cautions:**
- In the case of a long stroke with foot mounting, we recommend using the rod side piping: **-RA** double foot type mounting.
 - When using mounting threads on a rod cover in the basic mounting, use a mounting screw that can utilize the entire effective thread depth of the mounting thread.
 - Avoid cantilever mountings by using mounting threads on a head cover piping adapter or head cover mounting bracket.



General precautions

Media

- Use air for the media. For the use of any other media, consult us.
- Air used for the cylinder should be clean air that contains no deteriorated compressor oil, etc. Install an air filter (filtration of a minimum 40 μ m) near the cylinder or valve to remove collected liquid or dust. In addition, drain the air filter periodically. Collected liquid or dust entering the cylinder may cause improper operation.

Lubrication

The product can be used without lubrication, if lubrication is required, use Turbine Oil Class 1 (**ISO VG32**) or equivalent. Avoid using spindle oil or machine oil.

Atmosphere

- If using in locations subject to dripping water, dripping oil, etc., or to large amounts of dust, use a cover to protect the unit.
- The product cannot be used when the media or ambient atmosphere contains any of the substances listed below. Organic solvents, phosphate ester type hydraulic oil, sulphur dioxide, chlorine gas, or acids, etc.

● Applicable fittings

Cylinder type	Bore size mm [in.]	16, 20 [0.630, 0.787]	25 [0.984]	32, 40 [1.260, 1.575]
Head side piping : -HA Rod side piping : -RA		<ul style="list-style-type: none"> ● Quick fitting, mini type for ϕ 3, ϕ 4, ϕ 6 tubes ● Quick fitting for ϕ 4 tube ● TAC fittings 	<ul style="list-style-type: none"> ● Quick fitting, mini type for ϕ 4 or ϕ 6 tubes ● Quick fitting for ϕ 4 or ϕ 6 tubes (excluding SL4-01 and SL6-01 and TSH8-01) ● TAC fittings 	<ul style="list-style-type: none"> ● Quick fitting, mini type for ϕ 6 tube ● Quick fitting for ϕ 6 or ϕ 8 tubes ● TAC fittings
Rod side piping Block type : -RB		<ul style="list-style-type: none"> ● Quick fitting, mini type for ϕ 3, ϕ 4, ϕ 6 tubes ● Quick fitting for ϕ 4 tube ● TAC fittings (excluding BF□N, BF□U, SF, and PF) 		

● Applicable speed controller

Cylinder type	Bore size mm [in.]	16, 20 [0.630, 0.787]	25~40 [0.984~1.575]
Head side piping : -HA Rod side piping : -RA		<ul style="list-style-type: none"> ● Speed controller with quick fitting ● SCO-US, SCO-UL ● TSC-US, TSC-US-BF 	
Rod side piping Block type : -RB		<ul style="list-style-type: none"> ● Speed controller with quick fitting 	<ul style="list-style-type: none"> ● Speed controller with quick fitting