

Field proven mechanism offers reliable vacuum application and durability.

SQUARE TYPE SOLENOID VACUUM VALVES

Rational mechanism, pursuing ease of use and reliability, achieves proven results and ensured operation. High performance 2-, 3-port direct acting solenoid vacuum valve series is available in the solenoid valves 030, 050, 100, and 200 series.

- The V030 series is a space-saving, low current type capable of handling multiple vacuum pads on a one-to-one basis. A choice of wiring type is offered. Surge-suppression measures are standard for both AC and DC.
 - The V100 and V200 series can be used as NC (normally closed) and NO (normally open) 2-, 3-port valves with flexibility on piping ports and flow directions, and can also demonstrate their true value as selector valves (dual-pressure switching valves) or divider valves.
- The 3-port valve V030, V050, SV100 and SV200 series offers excellent reliability even when used in positive pressure applications, and is therefore optimum valve for use as a vacuum break or releasing workpiece valve.
- A flywheel diode is standard equipment on AC solenoids (except for V030, optional on the DC24V model), eliminating solenoid burning or humming.

Caution: Solenoid valves that can be used for vacuum applications include variations of the G010 series, the 112 and 182 series, and the F series. For details, see the pages of each series.

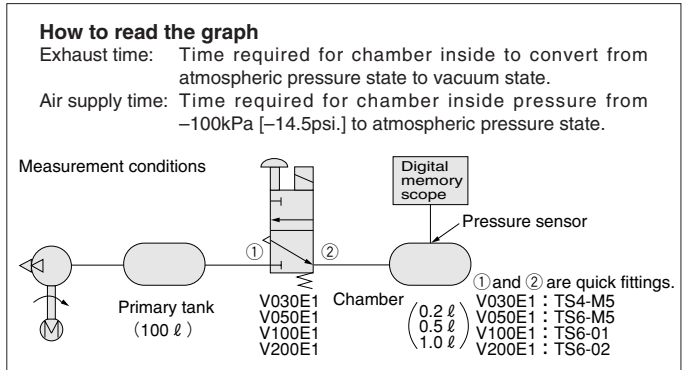

Solenoid vacuum valves **030** series

V030E1 (standard type)

- Uses a low current 65mA, 1.6A (DC24V) solenoid.
- Compact and lightweight with 15mm [0.591in.] width and 57g [2.01oz.] single-unit mass.

<Main specifications>

Effective area [Cv] 1(P)→2(A): 0.6mm² [0.02],
 2(A)→3(R): 0.8mm² [0.03]
 Port size 1(P), 2(A): M5×0.8, R: φ 1.8
 Operating pressure range ... -100~0kPa [-14.5~0psi.]



Exhaust time

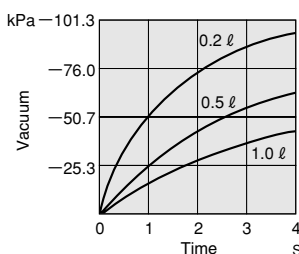

Air supply time

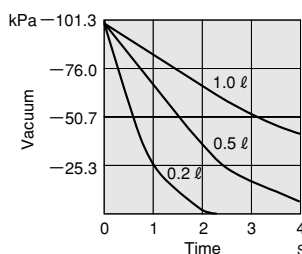

1kPa = 0.145psi.

Solenoid vacuum valves **050** series

Standard type V050E1/Low current type V050LE1

- Offers combined use of both vacuum and positive pressure states.
- Uses a poppet-type seal. Minimal problems of sticking due to collected liquid, for assured switching operations.

<Main specifications>

Effective Area [Cv] 1.5mm² [0.08]
 Port size M5×0.8 (Rc1/8)
 Operating pressure range ... -100~0kPa [-14.5~0psi.]
 0~0.7MPa [0~102psi.]

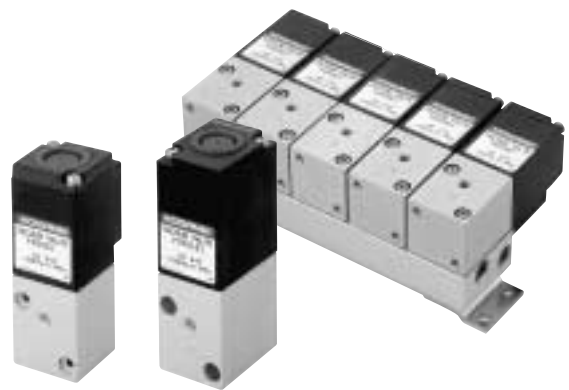

Exhaust time

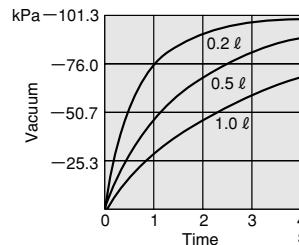

Air supply time

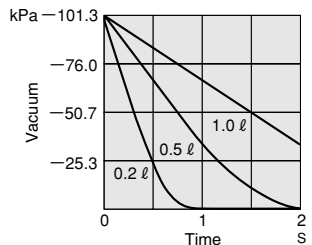

1kPa = 0.145psi.

Valve functions and connection port configurations

V030, V050

When not using positive pressure

		De-energized	Energized
2-port	Normally closed (NC)		
	Normally open (NO) (V050 only)		
3-port	Normally closed (NC)		
	Normally open (NO) (V050 only)		

When using both vacuum and positive pressure (V050 only)

		De-energized	Energized
3-port	Normally closed (NC)		
	Normally open (NO)		

V100, V200

		De-energized	Energized
2-port	Normally closed (NC)		
	Normally open (NO)		
3-port	Normally closed (NC)		
	Normally open (NO)		
Selector valve			
Divider valve			

SV100, SV200

		De-energized	Energized
3-port	Normally closed (NC)		
	Normally open (NO)		

Solenoid vacuum valves 100 series

Standard type V100E1/For both vacuum and positive pressure type SV100E1

- Uses a pressure-balance poppet for equalizing the air supply pressure at the valve seat portion.
- Small operating force suitable for high-cycled operations, offering large flow rate in a compact body.

<Main specifications>

Effective Area [Cv]5.0mm² [0.28]
 Port sizeRc1/8
 Operating pressure range ...-100~0kPa [-14.5~0psi.] (V100E1)
 -100~0kPa [-14.5~0psi.],
 0~0.9MPa [0~131psi.] (SV100E1)

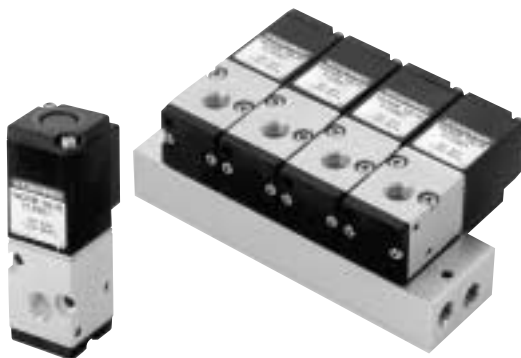

Exhaust time

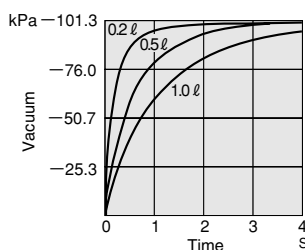

Air supply time

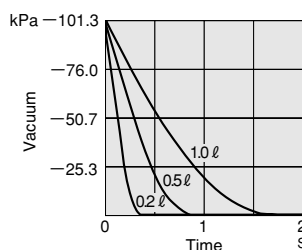

1kPa = 0.145psi.

Solenoid vacuum valves 200 series

Standard type V200E1/For both vacuum and positive pressure type SV200E1

- As in the 100 series, uses a pressure-balance poppet for equalizing the air supply pressure at the valve seat portion.
- Small operating force suitable for high-cycled operations, offering large flow rate in a compact body.

<Main specifications>

Effective Area [Cv]8.5mm² [0.47]
 Port sizeRc1/4
 Operating pressure range ...-100~0kPa [-14.5~0psi.] (V200E1)
 -100~0kPa [-14.5~0psi.],
 0~0.9MPa [0~131psi.] (SV200E1)

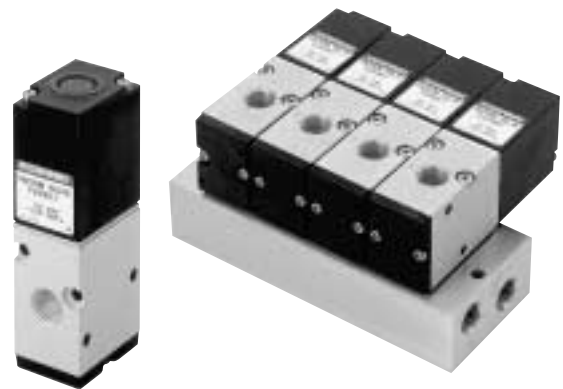

Exhaust time

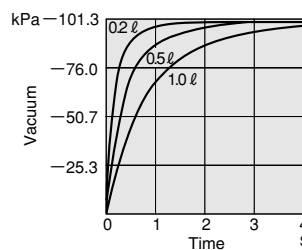

Air supply time

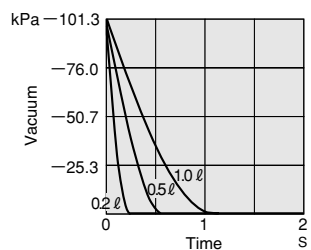

1kPa = 0.145psi.

SQUARE TYPE SOLENOID VACUUM VALVES

V030 Series



Specifications

Basic model		V030E1
Item		Vacuum
Media		Vacuum
Operation type		Direct acting type
Number of positions, Number of ports		2 positions, 2, 3 ports
Valve function		Normally closed (NC)
Effective area [Cv]	mm ²	1(P)→2(A): 0.6 [0.02], 2(A)→3(R): 0.8 [0.03]
Port size		1(P), 2(A): M5×0.8, 3(R): φ 1.8
Lubrication		Not required
Operating pressure range	kPa (mmHg) [in.Hg]	−100~0 {−750.1~0} [−29.53~0]
Response time ^{Note}	DC12V, 24V	10/25 or below
ON/OFF	ms AC100V, AC200V	15/40 or below
Maximum operating frequency	Hz	5
Operating temp. range (atmosphere and media)	°C [°F]	5~50 [41~122]
Shock resistance	Lateral direction	1373.0 [140.0]
	Axial direction	117.7 [12.0]
Mounting direction		Any
Mass	g [oz.]	57 [2.01]

Note: Values when vacuum is −100kPa {−750.1mmHg} [−29.53in.Hg].

Solenoid Vacuum Valve Port Size

Solenoid vacuum valve model	Port specification	Port size
V030E1	Female thread	1(P), 2(A): M5×0.8
	—	3(R): φ 1.8

Manifold Connection Port Size

Manifold model	Port	Location of piping connection	Port size
YM□T	1(P)	Manifold	M5×0.8
	3(R)		M6×1
	2(A)	Valve	M5×0.8

Manifold Mass

Manifold model	Mass calculation of each unit (n=Number of units)	Block-off plate
YM□T	(11×n)−1 [(0.39×n)−0.04]	3 [0.11]

g [oz.]

Solenoid Specifications

Rated voltage		DC12V	DC24V	AC100V	AC200V
Item					
Type		Flywheel diode incorporated for surge suppression	Flywheel diode type	Shading type	
Operating voltage range	V	10.8~13.2 (12±10%)	21.6~26.4 (24±10%)	90~132 (100 ± ³² / _{−10} %)	180~264 (200 ± ³² / _{−10} %)
Current (when rated voltage is applied)	Frequency Hz	—	—	50	60
	Starting mA (r.m.s.)	—	—	36	32
	Energizing mA (r.m.s.)	130 (1.6W) 140 (1.7W) { with LED indicator }	65 (1.6W) 75 (1.8W) { with LED indicator }	24	20
Allowable leakage current	mA	8	4	4	2
Insulation resistance	MΩ	Over 100			
Wiring type and lead wire length	Standard	Grommet type: 300mm [11.8in.]			
	Optional	Plug connector type: 300mm [11.8in.] See made to order on p.856.			
Color of lead wire		Brown (+), Black (−)	Red (+), Black (−)	Yellow	White
Color of LED indicator		Red		Yellow	Green
Surge suppression (as standard)		Flywheel diode		Varistor	

Order Codes

Solenoid Vacuum Valve Order Codes

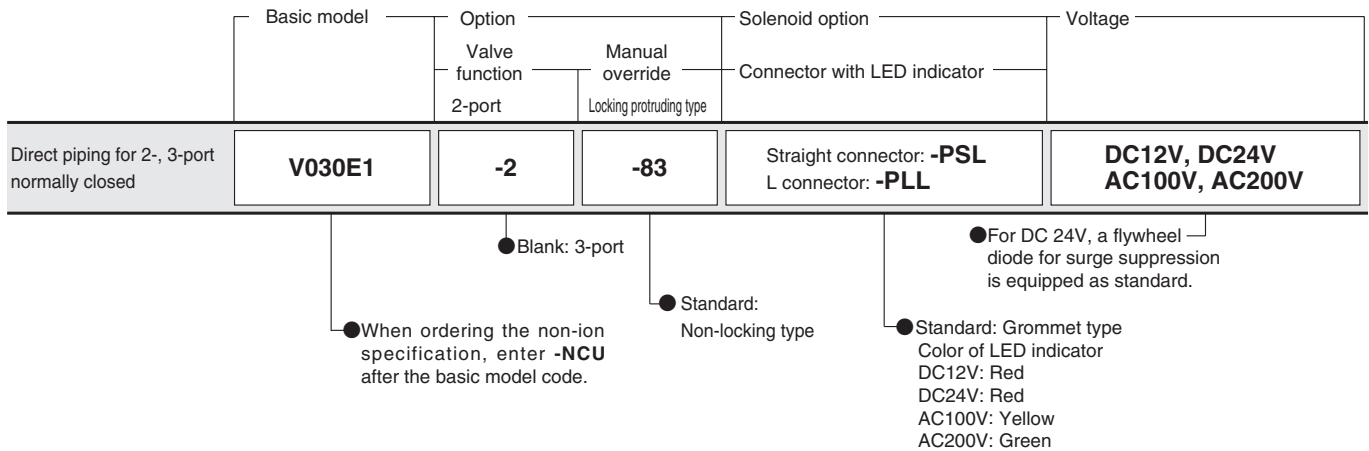

Manifold Order Codes

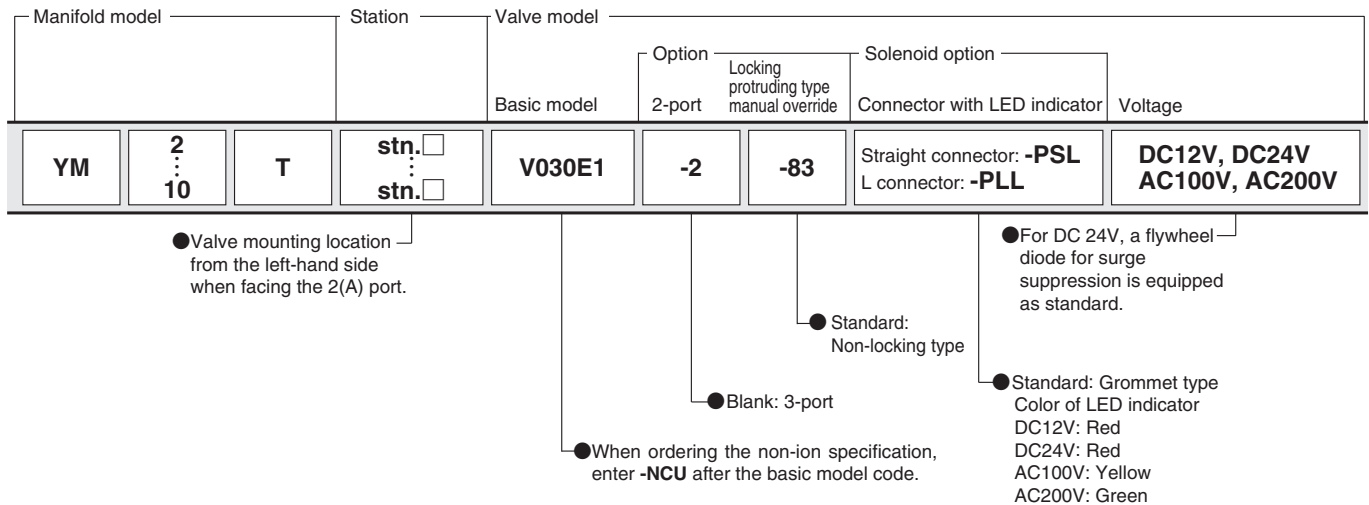

Additional Parts

Muffler



● For manifold only

Mounting base



Block-off plate



● YM T -BP
T—For T type manifold
YM—For YM

Options

Locking protruding type
manual override



Straight connector
with LED indicator



L connector
with LED indicator



Made to Order

For details, see the Solenoid Valves 030 Series.

Straight connector
with LED indicator



● Without lead wire
● Connector and contacts included

L connector
with LED indicator



● Without lead wire
● Connector and contacts included

Lead wire length

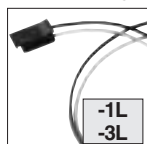

● For plug connector
● Length -1L: 1000 [39in.]
-3L: 3000 [118in.]

DIN connector



● Cannot be used with -L

LED indicator
with built-in varistor



● Cannot be used with -39

Built-in interface
unit



● Enables direct control by output from micro computer or other logic devices
● With LED indicator

Operating Principles and Symbol

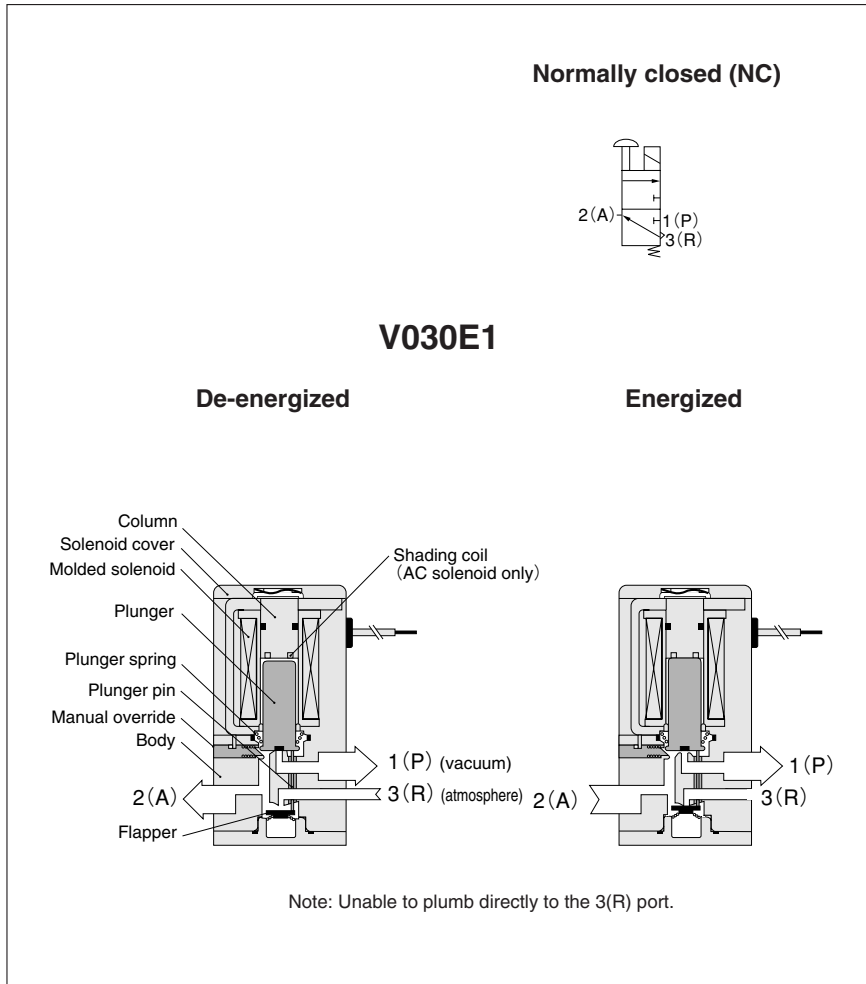

Valve functions and connection port configurations

V030

		De-energized	Energized
2-port	Normally closed (NC)		
	Normally closed (NC)		

Major Parts and Materials

	Parts	Materials
Valve	Body	Aluminum alloy (anodized)
	O-ring	Synthetic rubber
	Flapper	
	Plunger	Magnetic stainless steel
	Column	steel
	Spring	Stainless steel
Manifold	Mounting base	Mild steel (zinc plated)
	Body	Aluminum alloy (anodized)
	Block-off plate	
	Bracket	Mild steel (zinc plated)
	Seal	Synthetic rubber

Remark: Materials that generate copper ions are not used for the non-ion specification.

Dimensions of Solenoid Vacuum Valve (mm)

V030E1

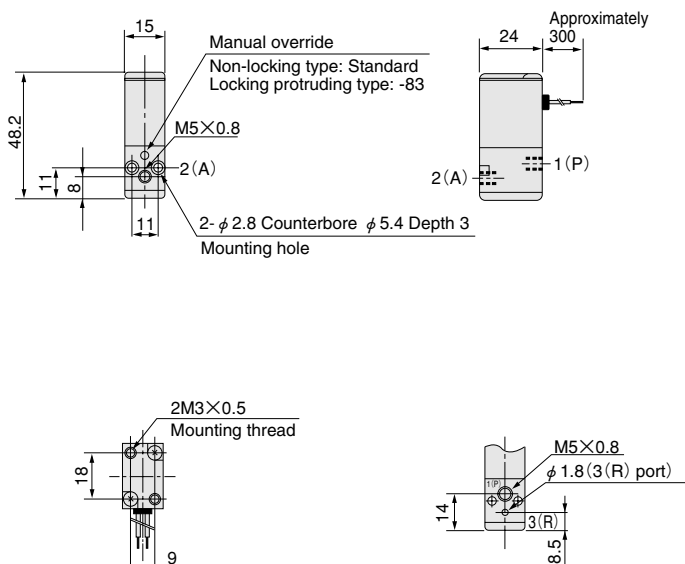

Dimensions of Manifold (mm)

YM□T

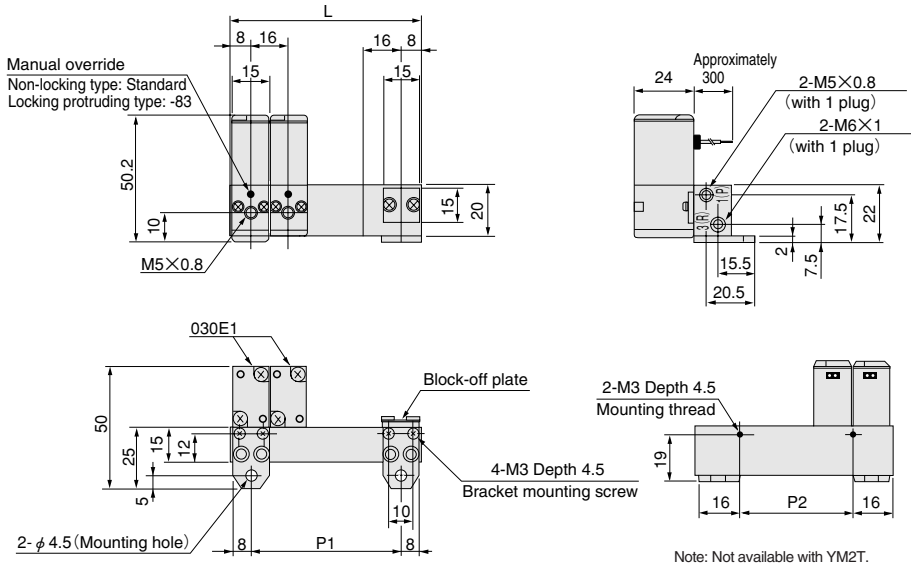

Unit dimensions

Model	L	P1	P2
YM2T	32	16	—
YM3T	48	32	16
YM4T	64	48	32
YM5T	80	64	48
YM6T	96	80	64
YM7T	112	96	80
YM8T	128	112	96
YM9T	144	128	112
YM10T	160	144	128

Additional Parts (To be ordered separately)

- Mounting base: 030-21

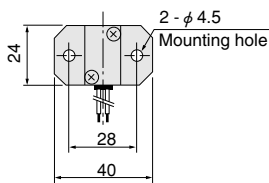
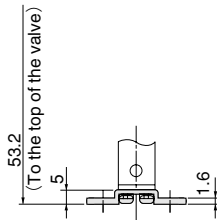

- Muffler: -75
For manifold only

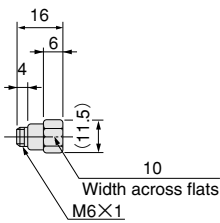

Options

- Locking protruding type manual override: -83

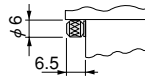

- Solenoid with straight connector: -PSL

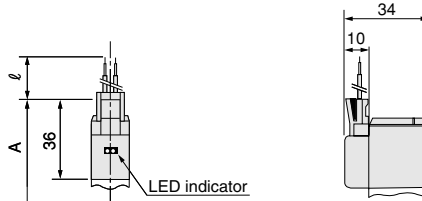

- Solenoid with L connector: -PLL

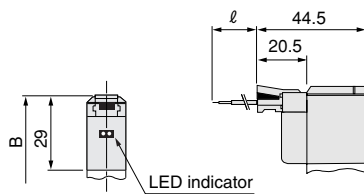

Made to Order

- Solenoid with DIN connector: -39

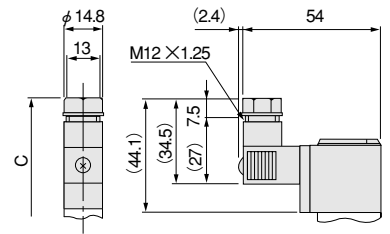

- Solenoid with LED indicator: -L

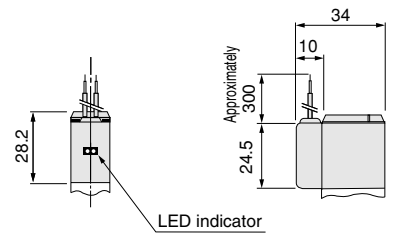

- Built-in interface unit: -FA

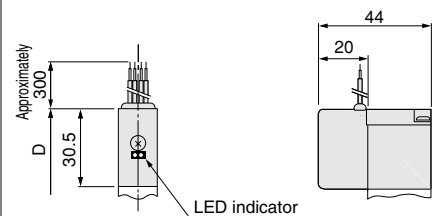

Model	Code	A	B	C	D	ℓ (lead wire length)	Remark
V030E1		56	49	64.1	50.5	-PSL, -PLL: 300 Made to order: -1L ; 1000 -3L ; 3000	Overall length to the end of the valve



Solenoid

Internal circuit

● DC12V, DC24V

Standard solenoid (Surge suppression)

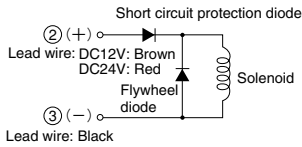

② and ③ are for with DIN connector (Order code: -39).

Solenoid with LED indicator (Surge suppression)

Order code: -PSL, -PLL

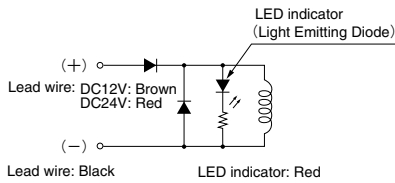

● AC100V, AC200V

Standard solenoid (Surge suppression)

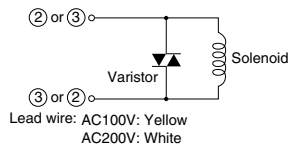

② and ③ are for with DIN connector (Order code: -39).

Solenoid with LED indicator (Surge suppression)

Order code: -PSL, -PLL

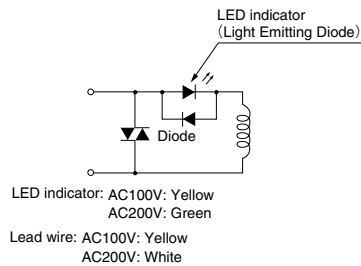

- Cautions:**
1. Do not apply megger between the lead wires.
 2. The DC12V and DC24V solenoids will not short circuit even if the wrong polarity is applied, but the valve will not operate.
 3. Leakage current inside the circuit could result in failure of the solenoid valve to return, or in other erratic operation. Always use it within the range of the allowable leakage current. When circuit conditions, etc. cause the leakage current to exceed the allowable leakage current, consult us.



Plug connector

Attaching and removing plug connector

Use fingers to insert the connector into the pin, push it in until the lever claw latches onto the protruded section of the connector housing, and complete the connection. To remove the connector, squeeze the lever along with the connector, lift the lever claw up from the protruded section of the connector housing, and pull it out.

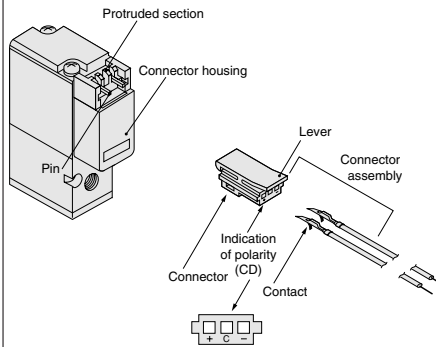

Crimping of connecting lead wire and contact

To crimp lead wires into contacts, strip off 4mm [0.16in.] of the insulation from the end of the lead wire, insert it into the contact, and crimp it. Be sure to avoid catching the insulation on the exposed wire crimping section.

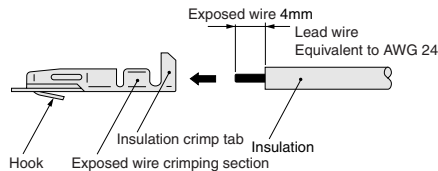

- Cautions:**
1. Do not pull hard on the lead wire.
 2. For crimping of connecting lead wire and contact, always use a dedicated crimping tool.
Contact: Model 702062-2M
Manufactured by Sumiko Tech, Inc.
Crimping tool: Model F1-702062
Manufactured by Sumiko Tech, Inc.

Attaching and removing contact and connector

Insert the contact with lead wire into a plug connector hole until the contact hook latches on the connector and is secured to the plug connector. Confirm that the lead wire cannot be easily pulled out. To remove it, insert a tool with a fine tip (such as a small screwdriver) into the rectangular hole on the side of the plug connector to push up on the hook, and then pull out the lead wire.

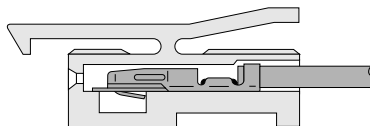

- Cautions:**
1. Do not pull hard on the lead wire. It could result in defective contacts, breaking wires, etc.
 2. When the pin is bent, use a small screwdriver, etc. to gently straighten out the pin, and then complete the connection to the plug connector.

Common terminal pre-wired plug connector

1. Pre-wired common terminal at DC positive side or AC.

Order code With straight connector: -CPSL
With L connector: -CPLL

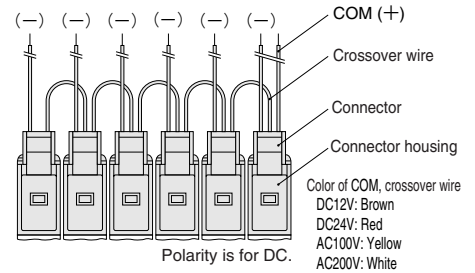

2. Pre-wired common terminal at DC negative side

Order code With straight connector: -CMSL
With L connector: -CMLL

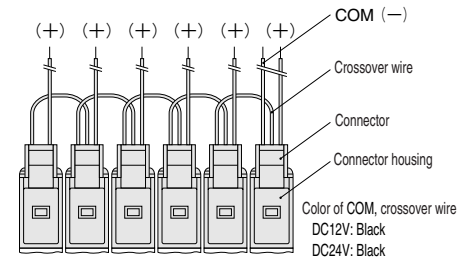

- Cautions:**
1. The diagrams show a straight connector configuration. While the connector's orientation is different in the case of the L connector, in every case the COM lead wire comes from the last station's mounted valve.
 2. Since the COM terminal is connected to a crossover terminal inside the connector housing, the connector cannot be switched between a positive common and a negative common by changing the connectors.



Manual override

Non-locking type, locking protruding type

For the non-locking type manual override, use an object with a fine tip to push the manual override down all the way. The valve works the same as when in the energized state as long as the manual override is pushed down, and returns to the rest position upon release.

To lock the locking protruding type manual override, use a finger tip or a small screwdriver to push down on the manual override all the way and turn it 45 degrees. Either turning direction at this time is acceptable. When locked, turning the manual override from the locking position releases a spring on the manual override, returns it to its normal position, and releases the lock. When the manual override is not turned, this type acts just like the non-locking type. The valve works the same as in an energized state as long as the manual override is pushed down, and returns to the normal position upon release.

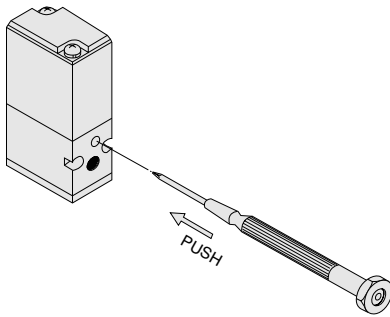

Caution: Always release the lock of the locking protruding type manual override before commencing normal operations.

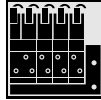

Manifold

Piping

The 1(P) port and 3(R) port are located on both end surfaces of the manifold, and the mounting location determines selection of piping direction. At shipping, ports on one side are plugged. Remove them, and then use sealing tape or other sealing agent, and then tighten .

Block-off plate

To close the unused stations, use a block-off plate (Order code: **-BP**).

Caution: For the 1(P) port piping, use a size that matches the manifold's piping connection port. Insufficient flow rate or vacuum could result in defective valve operation or in insufficient picking capacity with the vacuum pad.



General precautions

Mounting

1. While any mounting direction is acceptable, using the mounting base (Order Code: **030-21**) for installation, make sure to avoid applying strong shocks in the lateral direction.
2. When using in locations subject to dripping water or oil, or in extremely dusty locations, use a cover, etc. to protect the unit. In addition, install a muffler (Order Code: **KM-06**), etc. to the 3(R) port to prevent dust from entering the unit.
3. Before piping with valves, always thoroughly blow off foreign materials (blow by compressed air) in the piping interior. Entering machining chips or sealing tape, rust, etc., generated during plumbing could result in air leaks and other defective operations.
4. When mounting a valve unit inside the control panels or when the operation requires long energizing periods, provide heat radiation measures.

Media

Use air for the media. For use of any other media, consult us.

Atmosphere

Cannot be used when the substances listed below are found in the media and atmosphere. Organic solvents, phosphate ester type hydraulic oil, sulphur dioxide, chlorine gas, or other acids, etc.



Solenoid

Internal circuit

● **DC24V**

Standard solenoid

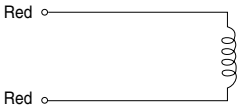

Solenoid with LED indicator

Order code: -LF,-L

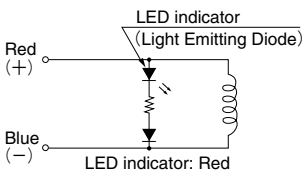

Solenoid with surge suppression

Order code: -SR

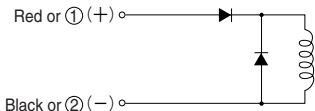

① and ② are for with DIN connector (Order code: -39).

Solenoid with LED indicator and surge suppression

Order code: -LF-SR

(V050 standard type, V100 and SV100 series)

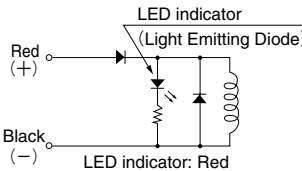

Solenoid with LED indicator and surge suppression

Order code: -L-SR

(V050 low current type, V200 and SV200 series)

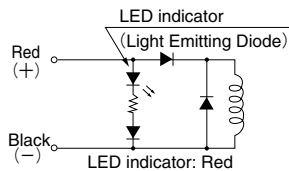

● **100V, AC200V**

(Surge suppression)

Standard solenoid

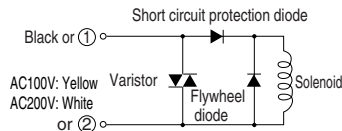

① and ② are for with DIN connector (Order code: -39).

Solenoid with LED indicator

Order code: -LF,-L

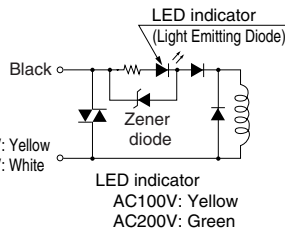

- Cautions:**
1. Do not apply megger between the lead wires.
 2. The DC24V solenoid will not short circuit even if the wrong polarity is applied, but the valve with surge-suppression will not operate. Also, the LED indicator will not turn on, for units with LED indicators.
 3. Leakage current inside the circuit could result in failure of the solenoid valve to return, or in other erratic operation. Always use within the range of the allowable leakage current. When circuit conditions, etc. cause the leakage current to exceed the allowable leakage current, consult us.
 4. Since the AC solenoid uses a diode for the solenoid, always connect lead wires of the same color when wiring a number of solenoid valves in parallel. The DC24V standard solenoid, however, has no polarity, so any lead wire connection is acceptable.

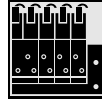

Manifold

Piping

The 1(P) port and 3(R) port are located at both end surfaces of the manifold, and the mounting location determines selection of piping direction.

At shipping, ports on one side are plugged. Remove them, and then use sealing tape or other sealing agent, and then tighten.

Block-off plate

To close the unused stations, use a block-off plate (Order code: -BP).

- Cautions:**
1. For the 1(P) port piping, use a size that matches the manifold's piping connection port.
 2. When installing piping or mufflers to the 3(R) port, ensure there will be minimum exhaust resistance.
 3. When multiple number of valves are operated simultaneously on a multi-units manifold, or when used at high frequency, use the 1(P) and 3(R) ports on both end surfaces.



General precautions

Mounting

1. While any mounting direction is acceptable, for installation using the mounting base (Order Code: -21), make sure to avoid applying strong shocks in the lateral direction.
2. When using in locations subject to dripping water or oil, or in extremely dusty locations, use a cover, etc. to protect the unit. In addition, install a muffler, etc. to the exhaust port to prevent dust from entering the unit.
3. Before piping with valves, always thoroughly blow off foreign materials (blow by compressed air) in the piping interior. Entering machining chips or sealing tape, rust, etc., generated during plumbing could result in air leaks and other defective operations.
4. When mounting a valve unit inside the control panels or when the operation requires long energizing periods, provide heat radiation measures.

Piping

In the V050, SV100, and SV200 series, the flow direction is limited. See p.854 for the valve functions and piping port configurations, then make the piping.

Media

1. Use air for the media. For use of any other media, consult us.
2. Air used for the valve should be clean air that contains no deteriorated compressor oil, etc. Install an air filter (filtration of 40µm or less) near the valve to remove collected liquid or dust. In addition, drain the air filter periodically.

Lubrication

While the unit can be used without lubrication, the Turbine Oil Class 1 (ISO VG32) or equivalent is recommended when using dry air (air that contains no moisture or oil content). Avoid using spindle oil or machine oil.

Atmosphere

Cannot be used when the substances listed below are found in the media and atmosphere. Organic solvents, phosphate ester type hydraulic oil, sulphur dioxide, chlorine gas, or other acids, etc.