

Seven Features of the Koganei Vacuum Valve

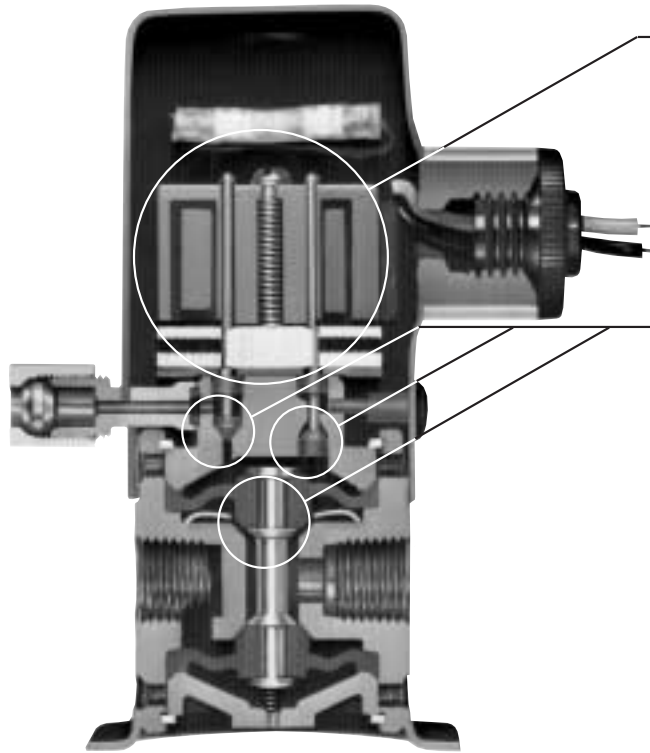

Koganei Original Solenoid Construction

- ① **No burning damage to solenoid**
No need to stock solenoids as spare parts.
- ② **Starting and energizing current values are extremely small.**
Allows for more compact size peripheral electrical equipment.

Poppet and Diaphragm Construction

- ③ **No sliding parts**
No valve sticking, for reliable operations.
- ④ **Extremely few cases of vacuum leakage**
Good vacuum response enables excellent pick-up by a vacuum pad and compact vacuum pump to install.
- ⑤ **Dust-resistant**
Can be used by installing just an ordinary air filter, even in dusty locations.
- ⑥ **Can be used without lubrication.**
Optimum valve for equipment incapable of using oil.
- ⑦ **Compact and lightweight, with any mounting direction acceptable**
Can be easily mounted to control panel, and allows for more compact equipment.

Application Examples

Opening bags

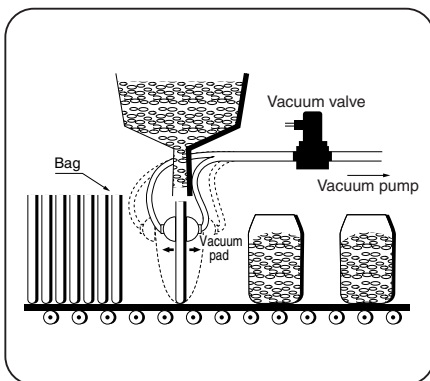

Quick charging of liquids

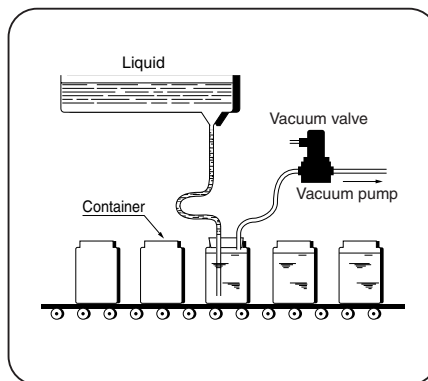

Paper feeding for printers

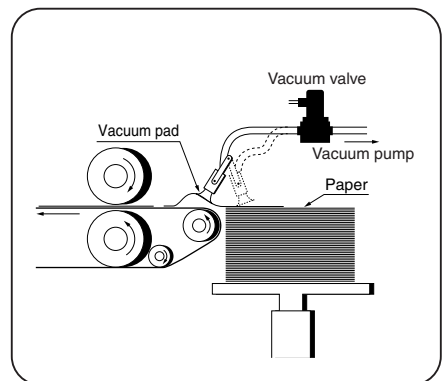

Vacuum forming machines

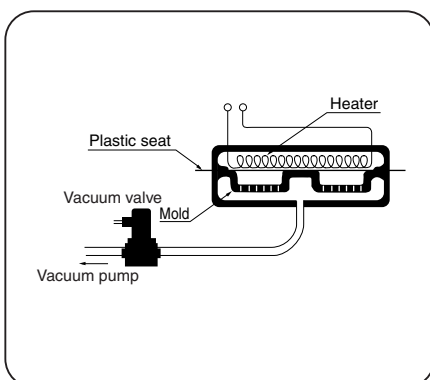

Discriminating product facing

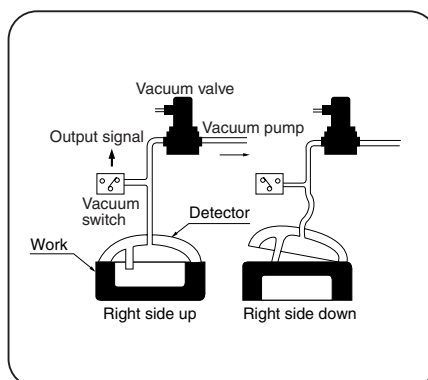

Labeling on cardboard boxes

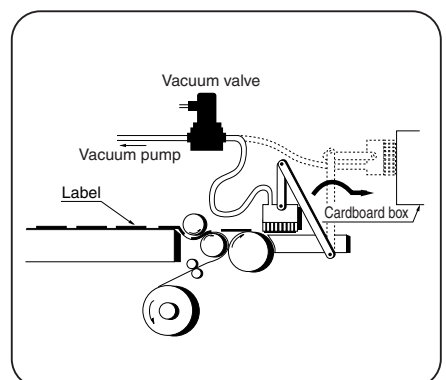

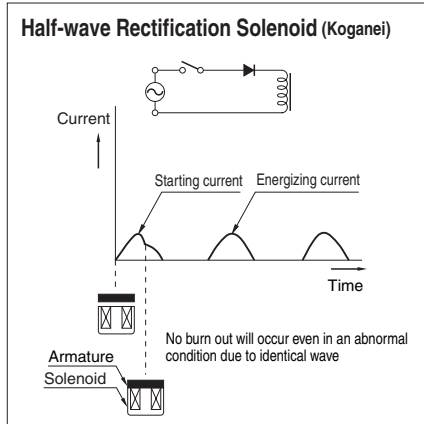
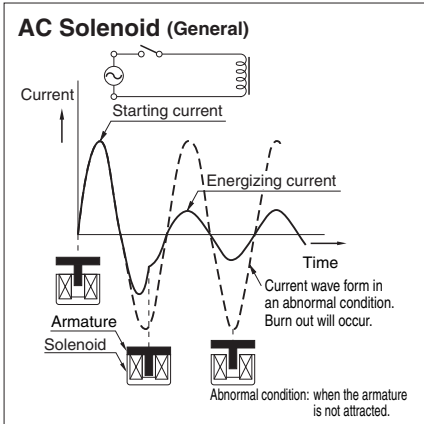

Koganei's ingenious self-developed solenoid

A silicon diode is installed on the end of the solenoid for half-wave rectification of the alternating current. The solenoid, therefore, possesses midway characteristics between the AC solenoid and DC solenoid. In addition, since the armature is designed to move as short a distance as possible, the starting current (inrush current) and energizing current are virtually identical and low current. As a result, the solenoid is not damaged even in abnormal conditions in which the armature fails to move, and the capacity of related electrical equipment can remain low.

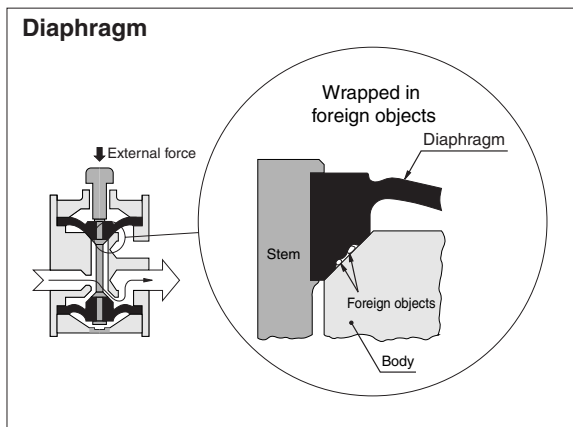
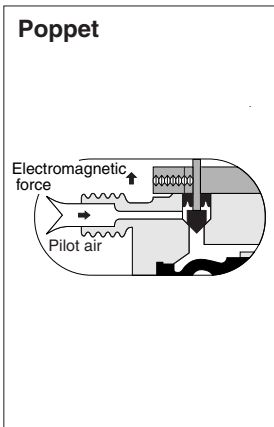

Poppet and diaphragm construction

The synthetic rubber poppet and diaphragm are built into the stem and move as one-piece. The poppet and diaphragm do not have any sliding surfaces, therefore no sticking occurs even without lubrication. In addition, the units have the elasticity of synthetic rubber to wrap in small foreign objects and keep vacuum leaks to an extremely low level.

Vacuum lifting

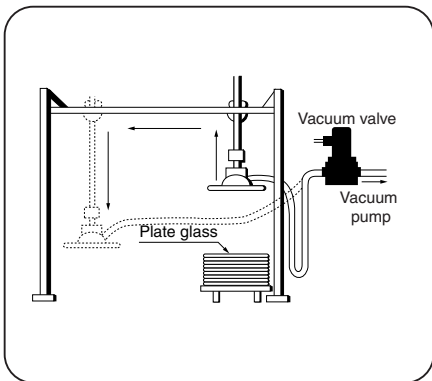

Reducing sheet transfer time (both vacuum and positive pressure)

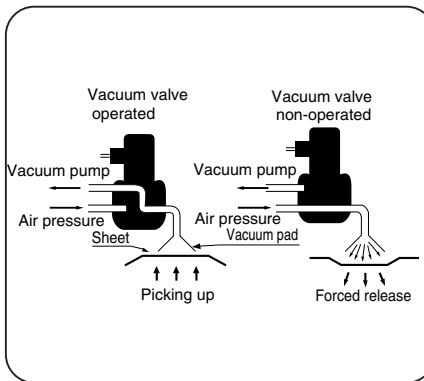

Tape speed controlling

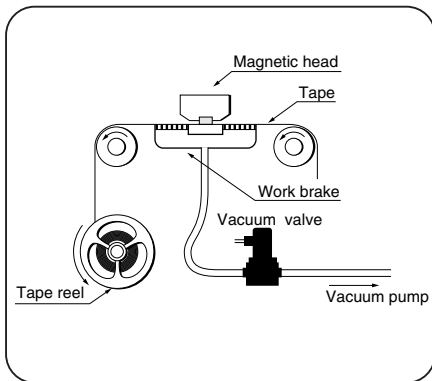

Holding subject (sheets)

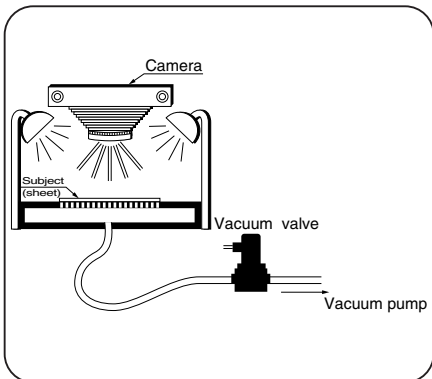

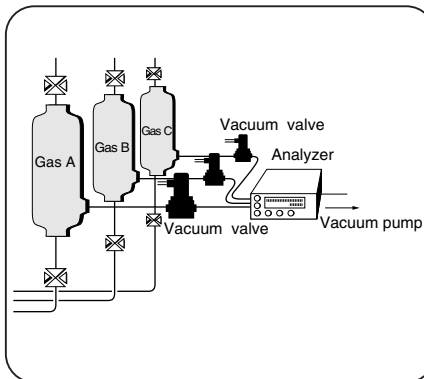

Inducing gas into analyzers

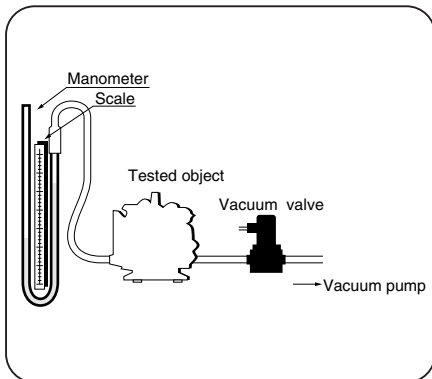

Airtightness inspecting

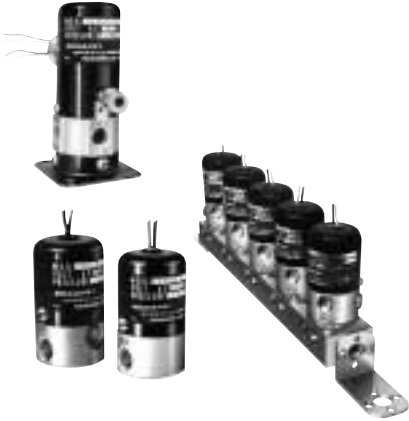
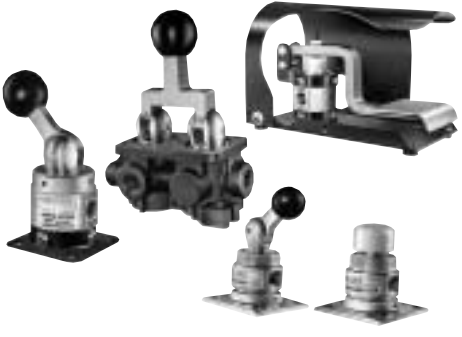

<Product Range>

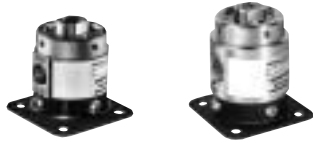
Products	Shape	Operation type		Port size Rc	Port	Function	Effective area (Cv) mm ²	Model	Page		
Solenoid vacuum valve		Single solenoid	Direct acting	1/4	2, 3	●NC ●NO	2.5 (0.12)	V062E1	961		
							5.5 (0.27)	SV062E1 (Both vacuum and pressure type)			
							15 (0.76)	V126E1			
			Indirect acting { External air pilot }	3/8	3		55 (2.7)	VA250AE1			
							55 (2.7)	VA2503AE1			
							55 (2.7)	VA500AE1			
		Indirect acting { External vacuum pilot }	1/4	3	15 (0.76)	VV250AE1					
					15 (0.76)	VV2503AE1					
					55 (2.7)	VV500AE1					
		Double solenoid (Continuously energizing type)	Indirect acting { External air pilot }	1/4	3	●NC/ NO	15 (0.76)	VA250AE2	964		
55 (2.7)	VA2503AE2										
55 (2.7)	VA500AE2										
Manual vacuum valve and foot vacuum valve		Push button	Spring return	1/8	3	●NC	5.5 (0.27)	V125P	970		
							With holding mechanism	1/4		15 (0.76)	V250P
								3/8		V2503P	
		Lever	Holding type	1/8	3	●NC/ NO	5.5 (0.27)	V125HO			
							1/4	V125V			
							3/8	V250V			
							1/4	V2503V			
							3/8	V250-4H			
		Foot	Pedal type	1/4	5	—	15 (0.76)	V2503-4H			
							2, 3	●NC	V250F		
Mechanical operated vacuum valve		Ball-cam		1/8	3	●NC	5.5 (0.27)	V125B	973		
							1/4	V250B			
							3/8	V2503B			
		Roller-cam	Nylon roller	1/4	2, 3	●NC	15 (0.76)	V250C			
							3/8	V2503C			
			Steel roller One way steel roller	1/8	3		5.5 (0.27)	V125MC			
Piloted vacuum valve		Air pilot (single)		1/8	3	●NC	5.5 (0.27)	VA125A	976		
							1/4	15 (0.76)		VA250A	
							3/8	VA2503A			
		Vacuum pilot (single)		1/2	3		55 (2.7)	VA500A			
							1/4	15 (0.76)	VV250A		
							3/8	VV2503A			
		Double air pilot		1/4	2, 3	●NC/ NO	15 (0.76)	250A2	979		
							3/8	2503A2			
							1/2	55 (2.7)		500A2	
							3/4	140 (7)		750A2	
			1			280 (14)	1000A2				

Safety Precautions (Solenoid Vacuum Valve Series)



Warnings

1. When mounting a valve inside a control panel or when an operation requires long energizing periods, provide heat radiation measures to ensure that the ambient temperature always remains within the temperature range specifications. For long term continuous energizing, consult us.
2. Always check the Catalog, etc., when carrying out wiring and piping of products to ensure that the connections are correctly done. Wrong wiring or piping could result in abnormal operation to the actuator, etc.
3. The solenoid valve's silicon diode could be damaged by surge voltage when a large induction load is used on the same power supply. Either change to a separate power supply, or mount a surge absorber to protect the unit. Solenoids with surge suppression are also available. Consult us.



Caution

For locations subject to water or to large amounts of dust, use a cover, etc., to protect the valves. Also, install a muffler, etc., to the R port to prevent dust from entering. Intrusion of water or dust could result in short-term functional shutdowns, sudden drops in performance, or a reduced operating life.



Attention

1. Use clean air that does not contain degraded compressor oil, etc., and install a filter, etc., close to solenoid valves to remove dust or collected liquid.
2. Ensure that the piping port on the supply side is at the same area or larger than the solenoid valve's effective area.
3. When using an indirect acting valve, use a stop valve between it and the pressure source. When the stop valve is opened before the pressure reaches the minimum operating pressure, the indirect acting valve could fall into a neutral position. (All solenoid valves in the 250 series and up are indirect acting valves.)
4. When connecting 2 or more AC type solenoid valves to the same power supply, connect leads with the same lead wire color.
5. Since a diode is connected to the AC type solenoid valve, the solenoid may sometimes not turn on with the solid state-type relay (SSR) with zero-cross function. For this reason, pay attention before use to the ratings and precautions for use of the solid state-type relay.

Voltage Types and Current

Rated voltage V	Current A ^{Note}		
	50Hz	60Hz	
AC	230 [*]	0.063	0.055
	220 [*]	0.058	0.072
	200	0.070	0.065
	115 [*]	0.13	0.11
	110 [*]	0.12	0.16
	100	0.14	0.13
	48 [*]	0.41	0.37
	24 [*]	0.93	0.83

Note: The starting current and energizing current values are virtually identical, and fall within these values.

Rated voltage V	Current A	
DC	200 [*]	0.04
	110 [*]	0.08
	100 [*]	0.09
	48 [*]	0.19
	24	0.40
	12 [*]	0.75
	6 [*]	1.50

For ※ items, consult us for the delivery.

Wiring Instructions of Double Solenoid (E2) Type

This valve has 2 solenoids built into the top and mid section, and the lead wires are color-coded with vinyl tape. Energizing the red tape side (the upper side, solenoid S2) opens the valve, and energizing the gray tape side (the lower side, solenoid S1) closes the valve. This solenoid is a continuous energizing holding type.

Solenoid S1 energized

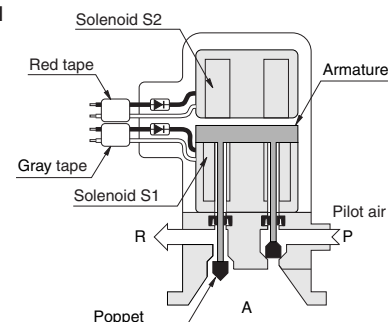

Solenoid Vacuum Valves Direct Acting Type

2-,3-port, Single Solenoid

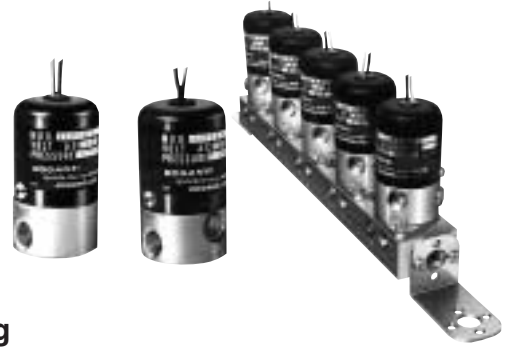

Specifications

Item	Basic model	V062E1	SV062E1	V126E1
Media		Vacuum	Vacuum, air	Vacuum
Operation type		Direct acting		
Number of ports		2, 3 ports	3 ports (Both vacuum and pressure type)	2 ports
Valve function		Normally closed (NC, standard), Normally open (NO, optional)		
Effective area [Cv]	mm ²	2.5 [0.12]		5.5 [0.27]
Port size	Rc	1/4		
Lubrication		Not required		
Operating pressure range	kPa (mmHg) [in.Hg]	0~100 {0~750} [0~29.53]		
Operating temperature range	°C [°F]	5~60 [41~140]		
Voltage type	V	Standard AC100 (50/60Hz), AC200 (50/60Hz) For other voltage, see p.960.		
Voltage fluctuations	%	±10		
Current ^{Note}	A	100V	50Hz→0.14, 60Hz→0.13	
	200V	50Hz→0.070, 60Hz→0.067		
Insulation type		B type		
Lead wire length	mm [in.]	Approximately 300 [11.8]		
Mounting direction		Any		
Mass	kg [lb.]	0.3 [0.66]		

Note: The starting current and energizing current values are virtually identical, and fall within these values.

Handling

1. When using in dusty ambient atmospheres, install a filter between the vacuum pad and the solenoid valve, and at the R port.
2. See p.983 for how to use SV062E1.

Solenoid Vacuum Valve Order Codes

	Basic model	Option			Solenoid option	Voltage	
		Valve function	Mounting base	Conduit type			
Direct piping	2-, 3-port	V062E1	-2	-11	-21	-37	AC100V AC200V
	3-port	SV062E1					
	2-port	V126E1					

- Blank: 3-port
(SV062E1: 3-port only
V126E1: Blank and 2-port only)

Manifold Order Codes

Manifold model	Station	Valve model	Option		Solenoid option	Voltage	
			Basic model	2-port	Conduit type		
MM	1 ⋮ 10	A	stn. <input type="checkbox"/> ⋮ stn. <input type="checkbox"/>	MV062E1	-2	-37	AC100V AC200V

- Blank: Side port only
A: With bottom piping port

- Valve mounting location from the left-hand side

- Enter -BP when closing a station with a block-off plate without mounting a valve.

Operating Principles and Symbols

V062E1

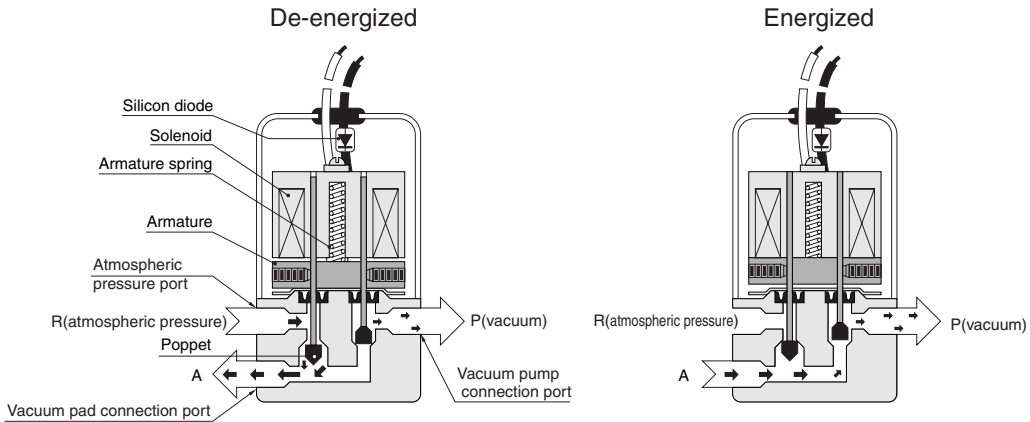

2-port NC	2-port NO	3-port NC	3-port NC	3-port NO
V062E1-2	V062E1-2-11	V062E1	SV062E1	V062E1-11

V126E1

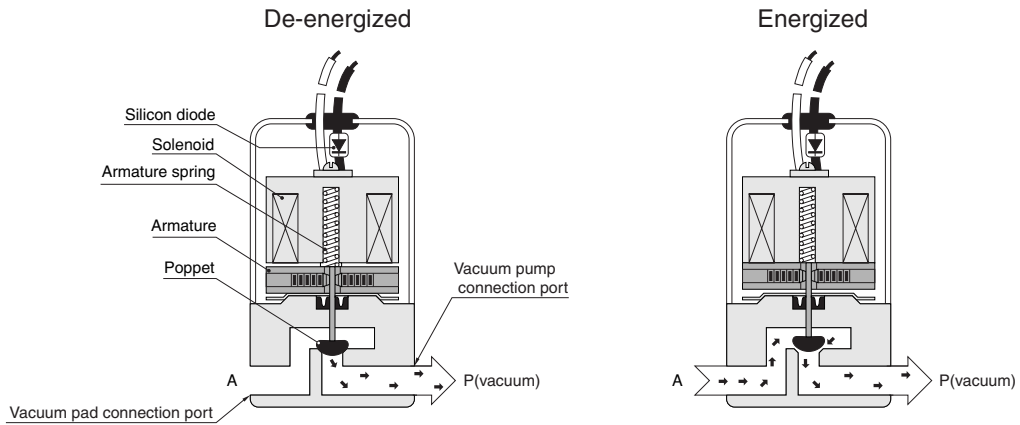

2-port NC	2-port NO
V126E1	V126E1-11

Reference

Vacuum Valve Selection Table (Exhaust and Air Supply Response Times)

s

Vacuum Model	50cc [3.05in ³] chamber				200cc [12.2in ³] chamber				1 l [61in ³] chamber				3 l [183in ³] chamber				5.5 l [336in ³] chamber				10.5 l [641in ³] chamber			
	Exhaust ^{Note}		Air supply		Exhaust		Air supply		Exhaust		Air supply		Exhaust		Air supply		Exhaust		Air supply		Exhaust		Air supply	
	0	0	-81.3 [-24.01]	-42.6 [-12.58]	0	0	-81.3 [-24.01]	-42.6 [-12.58]	0	0	-81.3 [-24.01]	-42.6 [-12.58]	0	0	-81.3 [-24.01]	-42.6 [-12.58]	0	0	-81.3 [-24.01]	-42.6 [-12.58]	0	0	-81.3 [-24.01]	-42.6 [-12.58]
V062E1	0.2	0.08	0.18	0.1	0.7	0.35	0.5	0.38	3.0	1.5	2.5	1.8	9.0	3.2	6.0	4.0	20.0	8.0	14.0	10.0				
V126E1	0.12	0.05	—	—	0.4	0.2	—	—	1.8	0.9	—	—	5.0	1.7	—	—	11.0	3.5	—	—				
VA125A	0.1	0.06	0.13	0.12	0.35	0.15	0.3	0.2	1.6	0.7	1.3	0.8	3.8	1.4	2.6	1.8	9.0	3.4	6.0	4.0				
VA250AE1	0.05	0.03	0.09	0.04	0.1	0.05	0.08	0.07	0.5	0.23	0.16	0.18	1.1	0.4	0.7	1.0	2.4	1.0	1.7	1.0				
VA500AE1	0.04	0.03	0.14	0.14	0.07	0.05	0.14	0.14	0.25	0.1	0.15	0.18	0.5	0.2	0.4	0.3	1.1	0.4	0.6	0.5	2.0	0.8	1.0	0.8
1000A2	—																0.26	0.14	0.26	0.2	0.4	0.2	0.4	0.3

Note: The exhaust vacuum in the chamber is a 80% rating value of the vacuum inside of the primary tank.

The above table shows the time it takes from the point in time where the vacuum valve is switched ON to reach the specified vacuum inside of the chamber, and the time from switching the vacuum valve OFF to supply air into the chamber.

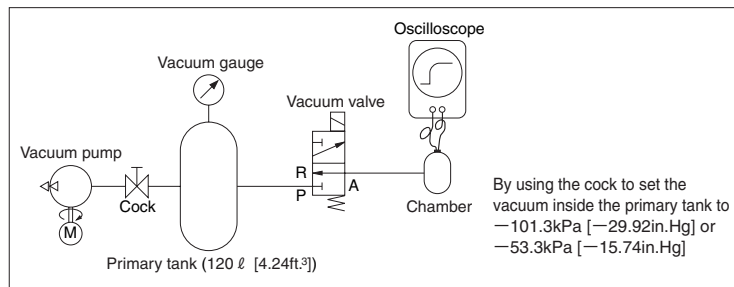

Standard Vacuum Circuit

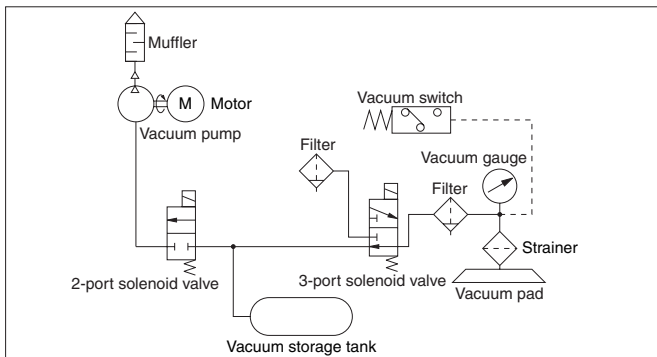

Inspection Standard for Vacuum Leaks (Koganei standards)

Inspection procedure

Open valve A, and set the vacuum in the tank to -100kPa [-750mmHg] [-29.53in.Hg]. Afterward, close valve A, let set for 10 minutes, and then check the vacuum inside of the tank both during OFF and ON.

Inspection standard

Let set for 10 minutes, then check to see that the vacuum leaks inside the tank meets the standard of 1.3kPa (10mmHg) [0.38in.Hg] or less.

For details, consult us.

Remark

In fact, most Koganei vacuum valves can hold initial vacuum even after being left set for 10 minutes.

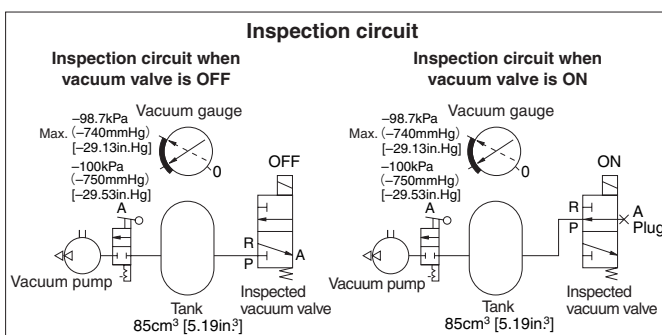

Calculation of Picking-up Force, and Graph (Theoretical values)

When using a vacuum pad to hold picking-up an object, the picking-up force is shown by the following formula.

$$W = P \times A \times 0.1$$

W: Picking-up force (N)
P: Vacuum (kPa)
A: Pad area (cm²)

<Conventional units>

$$W' = \frac{P'}{760} \times 1.033 \times A'$$

W': Picking-up force (kgf)
P': Vacuum (mmHg)
A': Pad area (cm²)

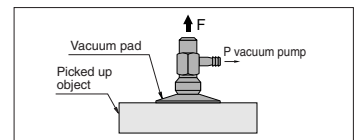

$$W'' = \frac{P''}{29.92} \times 14.7 \times A''$$

W'': Picking-up force [lbf.]
P'': Vacuum [in.Hg]
A'': Pad area [in.²]

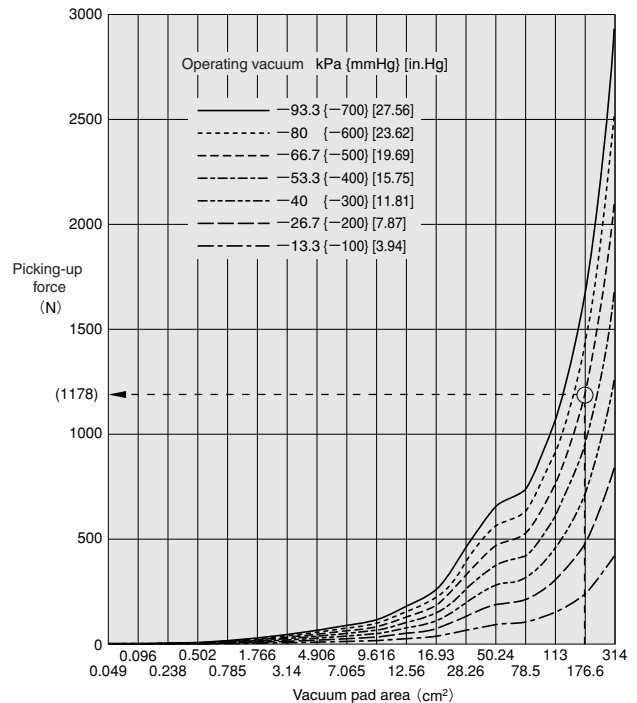

How to read the graph

When the vacuum is -66.7kPa [-19.7in.Hg], and the vacuum pad area is 176.6cm² [27.37in.²], the picking-up force is 1178N [265lbf.].

Reference

How to Use Both Vacuum and Pressure Type (SV062E1)

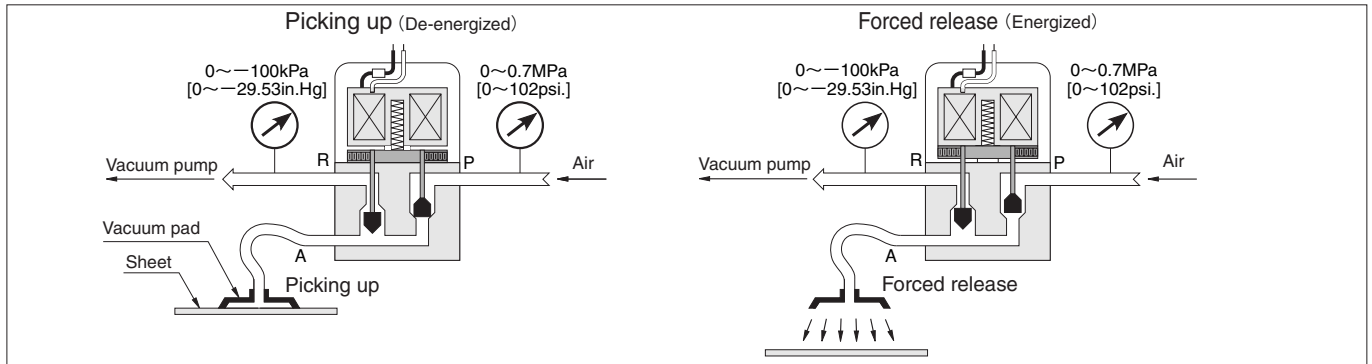

Application of External Air Pilot Type (VA250AE1/ VA2503AE1/ VA500AE1)

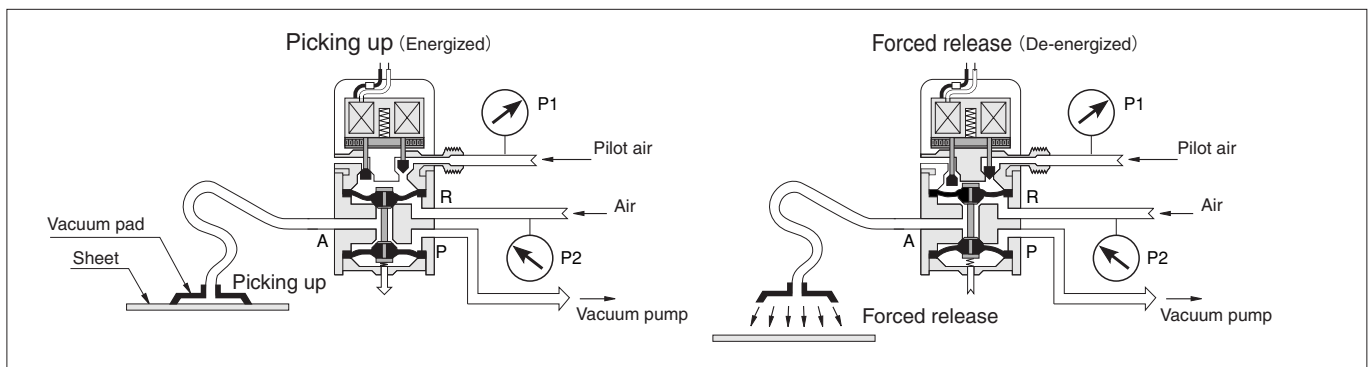

Note: Use as $P_1 > 2P_2$.

Application of External Double Air Pilot Type (250A2 / 500A2, etc.)

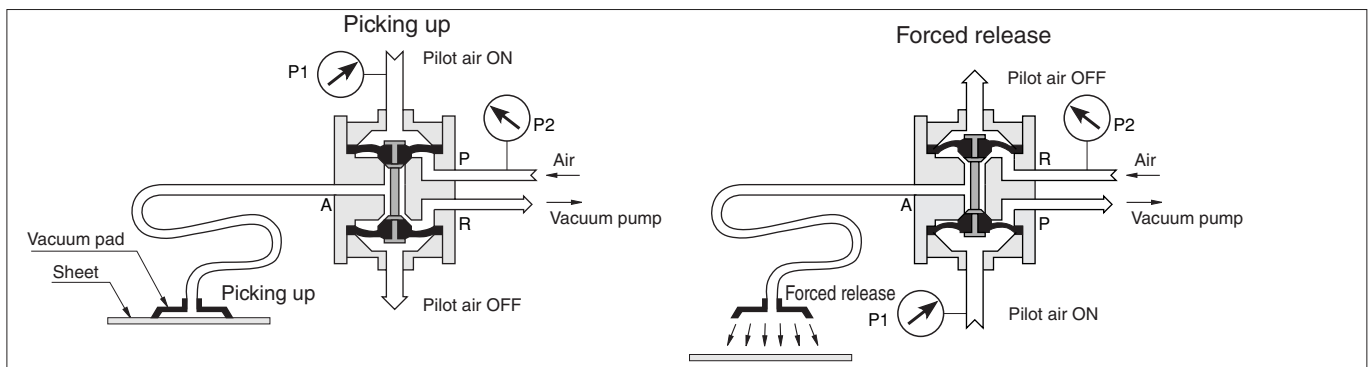

Note: Use as $P_1 > 2P_2$.

Pressure Unit Comparison Table

