

KOGANEI

Creceed イオンワイパー
(エアカーテンダウンブロー形)

ION WIPER

(Air Curtain Down Blow Type)

DTY-WCM-S DTY-WC-S

DTY-WCM-L DTY-WC-L

取扱説明書 Ver.2.0
Owner's Manual Ver. 2.0

目次 Contents





はじめに	2
1. イオンワイパー設置上の注意点	2
2. 概要	2
3. 機器の構成および機能	2
3-1. 各部名称および機能	3
4. 設置および配線・配管	
4-1. 一般的なイオンワイパー設置上の注意	4
4-2. 排気ダクト	4
4-3. 電源	4
4-4. アース（接地）	4
4-5. エア配管	4
4-6. エキスパンドメタルの取付	4
5. 操作	5
6. 保守と注意事項	8
7. 仕様	9
7-1. 寸法図	9
Introduction	12
1. ION WIPER Installation Precautions	12
2. Overview	12
3. Configuration and Functions of the Device	12
3-1. Major parts Name and Function	13
4. Installation, Wiring and Tubing	
4-1. Precautions on Installation of the ION WIPER	14
4-2. Exhaust Duct	14
4-3. Power Supply	14
4-4. Wiring for Grounding	14
4-5. Air Tubing	14
4-6. Installation of Expanded Metal	14
5. Operations	15
6. Maintenance and Precautions	18
7. Specifications	19
7-1. Dimensions	19

Introduction

Thank you for purchasing the ION WIPER.

The ION WIPER uses alternating voltage of 2000V, though it is not specified as high voltage devices in Electric Equipment Standards. Read carefully this manual and another supplied owner's manual for Ionizer Air Blow [DTRY-ELL01] before using, and handle carefully and properly. Always keep this manual for future reference.

1. ION WIPER Installation Precautions

 WARNING	This product is not explosion-proof. Do not install in locations where flammable gas or solvent is used such as a painting booth. It could ignite or explode.
 WARNING	Never touch and put metals such as wire or tools close to the ionizer. As a high voltage is applied to the discharging needle of the ionizer, it may cause electric shock or breakdown. For installation of the unit, avoid locations subject to oil or water, high temperature or high humidity, due to this product's high voltage use. Especially avoid a place subject to high humidity and dew condensation.
 WARNING	Always shut off power before cleaning the discharging needle. Handle the needle with caution because it has a sharp pointed tip. Wrong handling of it could result in body injury.
 WARNING	This device is designed for use with air. Always supply air before turning the power on.

2. Overview

The ION WIPER is a unit that removes static charges and dust accumulated on the workpiece (charged object). The installed Ionizer generates ionized air to neutralize static charges on the object and at the same time blows the dust off from the surface of the object. The air blown from the front and upper parts of the both sides forms air curtain, and it prevents the blown-off dust from contaminating on the surrounding working environment. In addition, the built-in blower fan collects and vents dust through the exhaust duct on the back side. (Built-in blower fan type: DTY-WCM-□)

3. Configuration and Functions of the Device

The ION WIPER consists of functional components such as the Ionizer (DTRY-ELL01), air curtain, blower fan, and control circuit for electricity and air that activate those functional components. For products without equipped blower fan (DTY-WC-□), the following external signal outputs (contacts) are provided: [VAC START contact] for operation signal of external device to collect dust, [ION END contact] for a signal to count number of Ionizer operation times, and [ERROR contact] to indicate abnormal stop of the Ionizer.

3-1. Major parts Name and Function

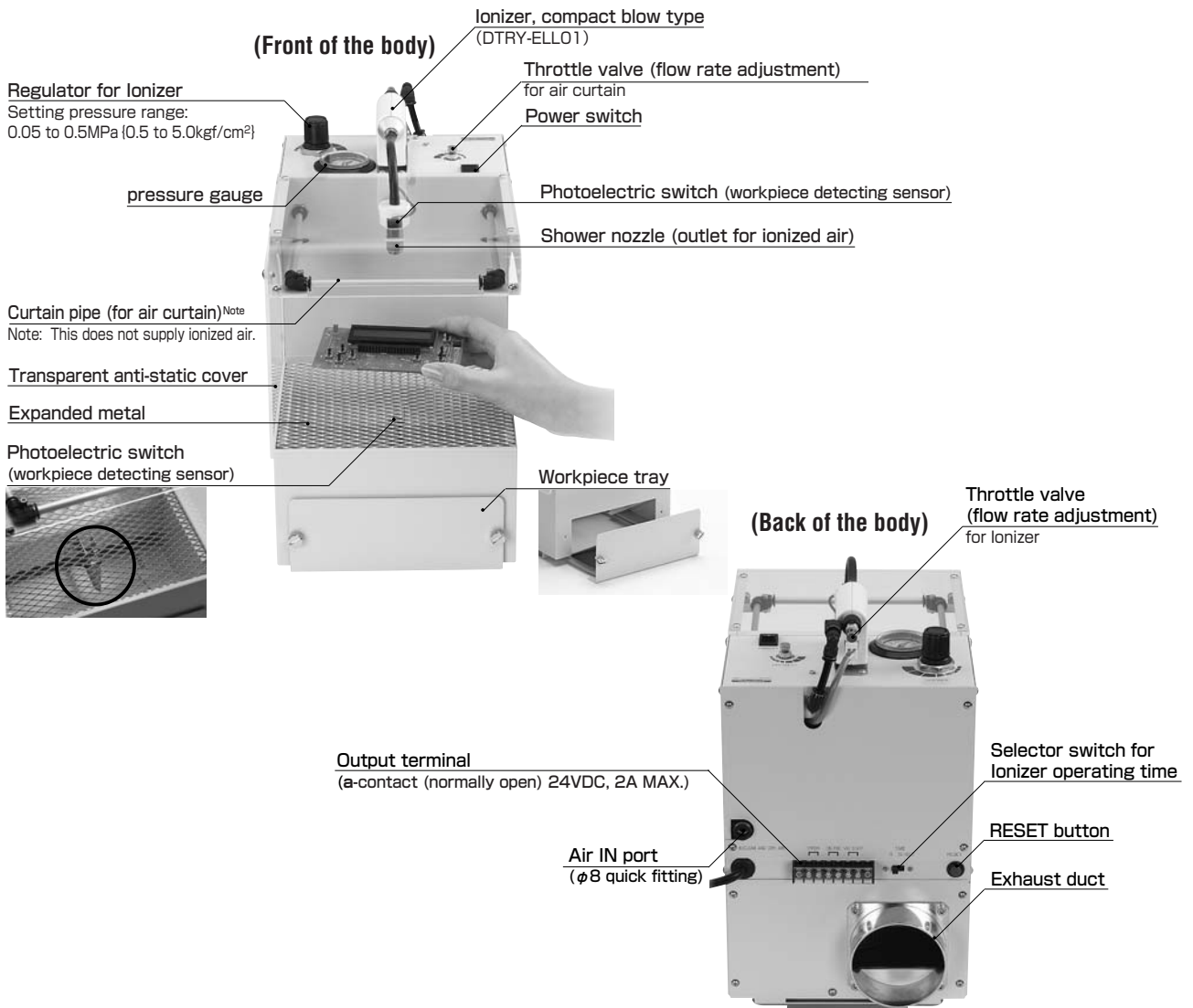

Output terminal

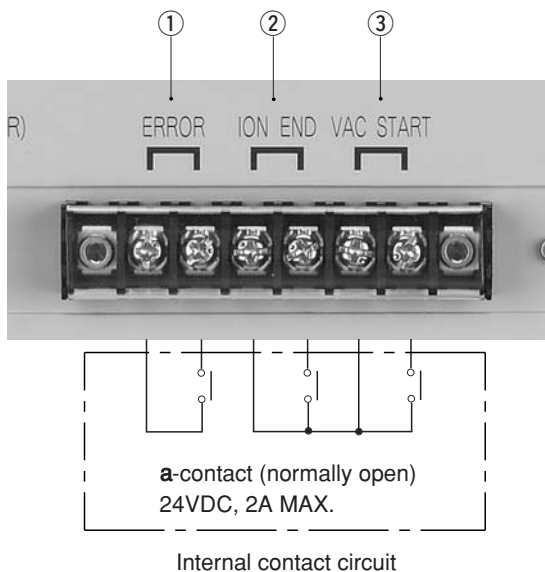

4. Installation, Wiring and Tubing

4-1. Precautions on Installation of the ION WIPER

- Use the ION WIPER indoors. For installation of the unit, care should be taken to the contamination by oil or water, high temperature and high humidity.
- Especially, avoid a place subject to dew condensation.
- Install the unit on a solid and flat surface such as a working bench. Avoid unstable places.
- Prevent the installed metal cap of the Ionizer from contacting its metal frame, etc.

4-2. Exhaust Duct

- Outer diameter of the exhaust duct is $\phi 76.3$. Caution should be exercised for exhaust resistance when connecting such as exhaust hoses. (Recommended nominal diameter of the exhaust hose: $\phi 75$)

Caution DTY-WCM-□ has a blower fan inside the duct. Be careful not to be injured by the fan or damage of the fan.

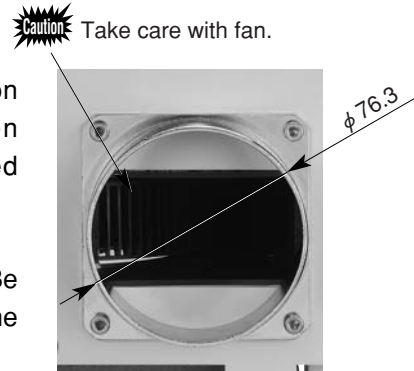

4-3. Power Supply

- Apply 100VAC (50/60Hz) for power supply of the unit.

4-4. Wiring for Grounding

- Always connect to an outlet with grounding electrode in order to prevent electrostatic charging of the whole unit and to make use of full performance of the Ionizer.
- When using an outlet without grounding electrode unavoidably, always use F.G. screw (M3) located beside the duct to connect for grounding. Check to ensure that the lead wire for grounding is not damaged.

Note: When used with defective grounding of the ION WIPER, static charge elimination and dust removal performance will degrade.



F.G. (M3)

4-5. Air Tubing

- Use urethane or nylon tube with outer diameter of $\phi 8$ for air tubing to the ION WIPER.
- The ION WIPER is designed to remove dust accumulated on the workpiece (charged object). Supply clean air that passes through a dryer or filter.

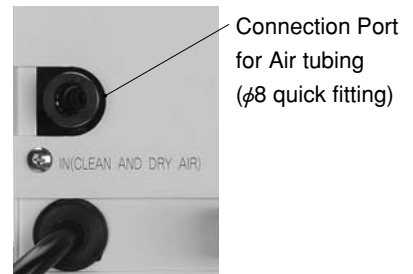

4-6. Installation of Expanded Metal

- Install the expanded metal from the front side of the main body as shown in the picture. Align cutout portion of the expanded metal (one place for A4, two places for A3) with the top of the photoelectric switch.

Caution Handle the expanded metal carefully as the cut section is very sharp.

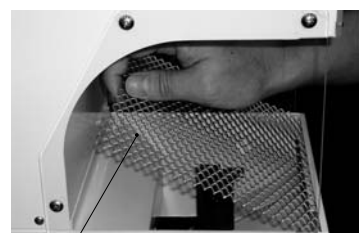

Expanded metal

5. Operations

- ① Install the ION WIPER on the stable and flat location, then connect the power supply, grounding, air tubing and exhaust duct.
- ② Open the main valve of air unit (purchased and installed by the customer) and adjust the regulator of the Ionizer. Adjust the supplied air pressure for the Ionizer in the range of 0.05 to 0.5MPa.



- ③ Set the blowing time by using the selector switch for ionizer operating time on the back of the main body, according to the charged condition of the workpiece and amount of dust.

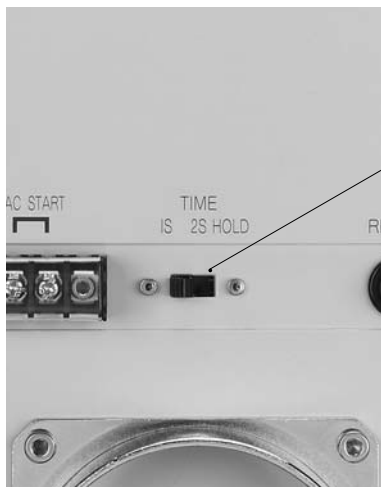

Selector switch for ionizer operating time
(ionized air blow time)

Time to set for ionized air blow

1S : to blow for one sec.

2S : to blow for two sec.

HOLD : to blow continuously

- ④ Turn the power on. Check to ensure that the indicator for the workpiece detecting sensor turns on, then place a work. The sensor detects that the workpiece is positioned and starts operation. (DTY-WC□-L starts operation when either of the sensors (right or left) detects the workpiece.)

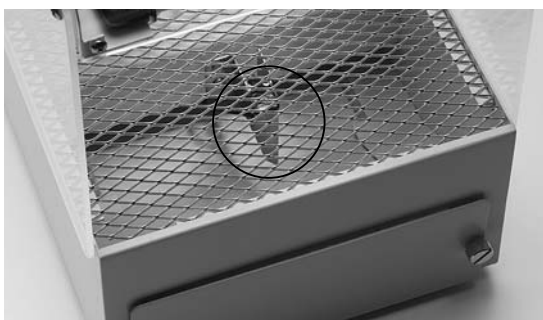

- ⑤ The ION WIPER operates for the time set in ③ and then stops, and the process for removing static charges and dust is completed.

When the time for blowing is set to [HOLD], ionized air blow is continued while the workpiece is placed (while the sensor detects the work).

- ⑥ To adjust the flow rate of the ionized air blow, use the throttle valve on the back of the Ionizer. Also, to adjust flow rate of air curtain, use the throttle valve for air curtain. Adjust them according to the charged condition of the workpiece and amount of dust as like procedure ③.



- ⑦ When abnormal stop occurs due to faulty removal of static charges

The ION WIPER has a function to promptly detect the abnormal condition of the installed Ionizer and to stop operation of the ION WIPER. Possible causes for abnormal stop are as follows:

- (a) High voltage output is decreased.
- (b) Metal cap is loosened (defective tightening) or contacts with the grounded object.
- (c) Close to short-circuited condition occurs between the discharging needle and grounding electrode, because dirt or dust is accumulated on the electrode.

- ⑧ Cancelling abnormal stop

Turn the power off, pull the plug out and check the following:

- (a) Metal cap and nozzle do not contact with the grounded object.
- (b) Metal cap is securely tightened.
- (c) Remove the metal cap, and clean the insulation portion of the main body located near the discharging needle using isopropyl alcohol. Then re-install the metal cap.

When the unit stops because the metal cap of the Ionizer contacts with the grounded object (metal frame, etc.), the abnormal stop can be cancelled by the [RESET] button on the back of the main body without turning the power off, while in contact between them should be avoided and remedied..



⑨ Removing the side cover

The side cover can be removed during operation in accordance with the size of the workpiece (charged object) or for operating efficiency. As a pipe for air curtain is installed on the upper part of the side, no contamination of working environment occurs.



With side cover installed



With side cover removed

⑩ Removing the tray

The tray can be removed by loosening screws with knobs on the front of the body, when picking fallen objects or cleaning inside.



Note: Always supply air during operation of the ION WIPER. When the set pressure of the regulator for ionizer comes lower than the 0.05MPa, or the throttle valve is closed to stop the flow of ionized air blow, the unit or environment will be adversely affected.

Note: Performance of the ION WIPER to remove dust depends on the shape and charged condition of the workpiece (charged object), air pressure, and blowing time. Set appropriate air pressure, flow rate, blowing time in accordance with the workpiece.

6. Maintenance and Precautions

- If water, oil, paint, etc. are adhered on the unit, remove them with waste, cloth or the like.
- Static charge removal level will be reduced, if dirt is adhered on the tip of discharging needle of the installed lonizer. In that case, clean the needle with nylon brush (never use wire brush). Pull out the silicon tube from the lonizer and rotate the metal cap to remove. Clean the discharging needle and the surroundings by using waste and brush.

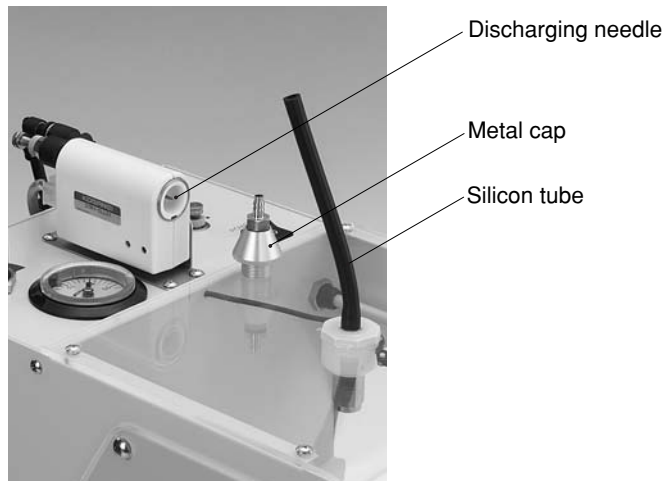

- Refer to the owner's manual of DTRY-ELL01 for the other maintenance and precautions regarding the lonizer.
- The ION WIPER has PLC in its control section. Please consult us when a contact in the circuit comes to the end of its operating life, because the PLC requires replacement and repair by the manufacturer. Recommended replacement interval is 1.5 to 2 years, depending on the frequency of operations. (Replacement and repair of the PLC is available on a chargeable basis.)

Warning: Before inspections, cleaning, or maintenance, be sure to switch off power supply. Before cleaning the discharging needle, handle the needle with caution, because it has a sharp pointed tip. Wrong handling of it could result in body injury.

7. Specifications

Model	DTY-WC-S	DTY-WCM-S	DTY-WC-L	DTY-WCM-L	
Blower fan	N/A	Built-in	N/A	Built-in	
Input voltage	100VAC \pm 10% (50/60Hz)				
Consumption current	mA	Approx.650	Approx.700	Approx.600	Approx.650
Installed ionizer	DTRY-ELL01 (1pc.)		DTRY-ELL01 (2pcs.)		
Ion balance ^{Note}	V	\pm 15			
Media	Air				
Static charge removing performance ^{Note}	1sec(1000V \rightarrow 100V, 0.5MPa, 50mm)				
Operating pressure range	MPa(kgf/cm ²)	0.2 to 0.7{2.0 to 7.0}			
Set pressure range for ionizer	MPa(kgf/cm ²)	0.05 to 0.5{0.5 to 5.0}			
Connection port	mm	ϕ 8 quick fitting			
Ionizer operating time (switched by a selector)	1sec, 2sec, continuous				
External output	ERROR (abnormal stop)	a-contact (normally open) (24VDC, 2A MAX)			
	ION END (completion of ionizer operation)	a-contact (normally open) (24VDC, 2A MAX)			
	VAC START (external device operation)	a-contact (normally open) (24VDC 2A MAX)			
Mass	kg	6.7	7.3	13.9	14.5
Other	Function to stop at abnormality of the ionizer (RESET button installed)				

Note: Values measured by in-house test standard. Not guaranteed performance.

7-1. Dimensions (mm)

DTY-WC-S DTY-WCM-S (Type A4)

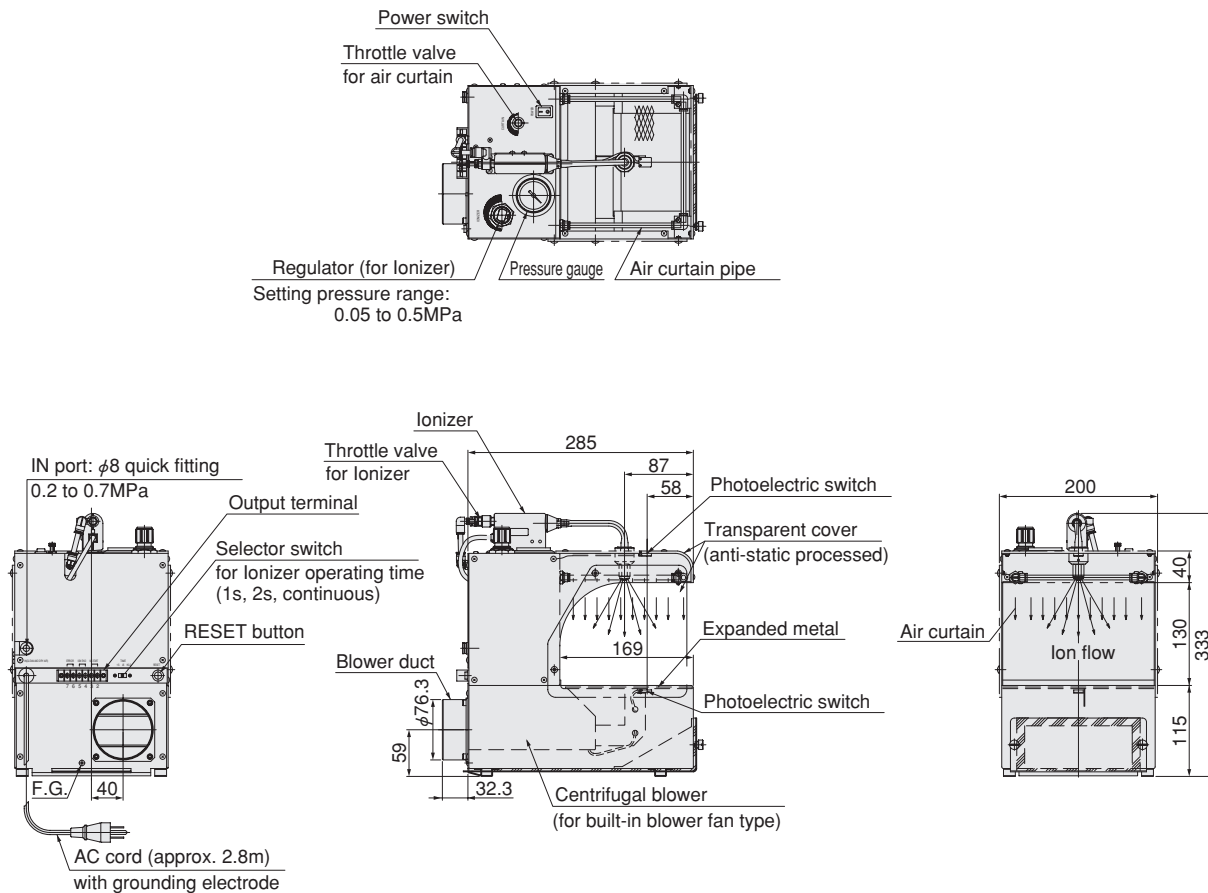

DTY-WC-L
DTY-WCM-L
 (Type A3)

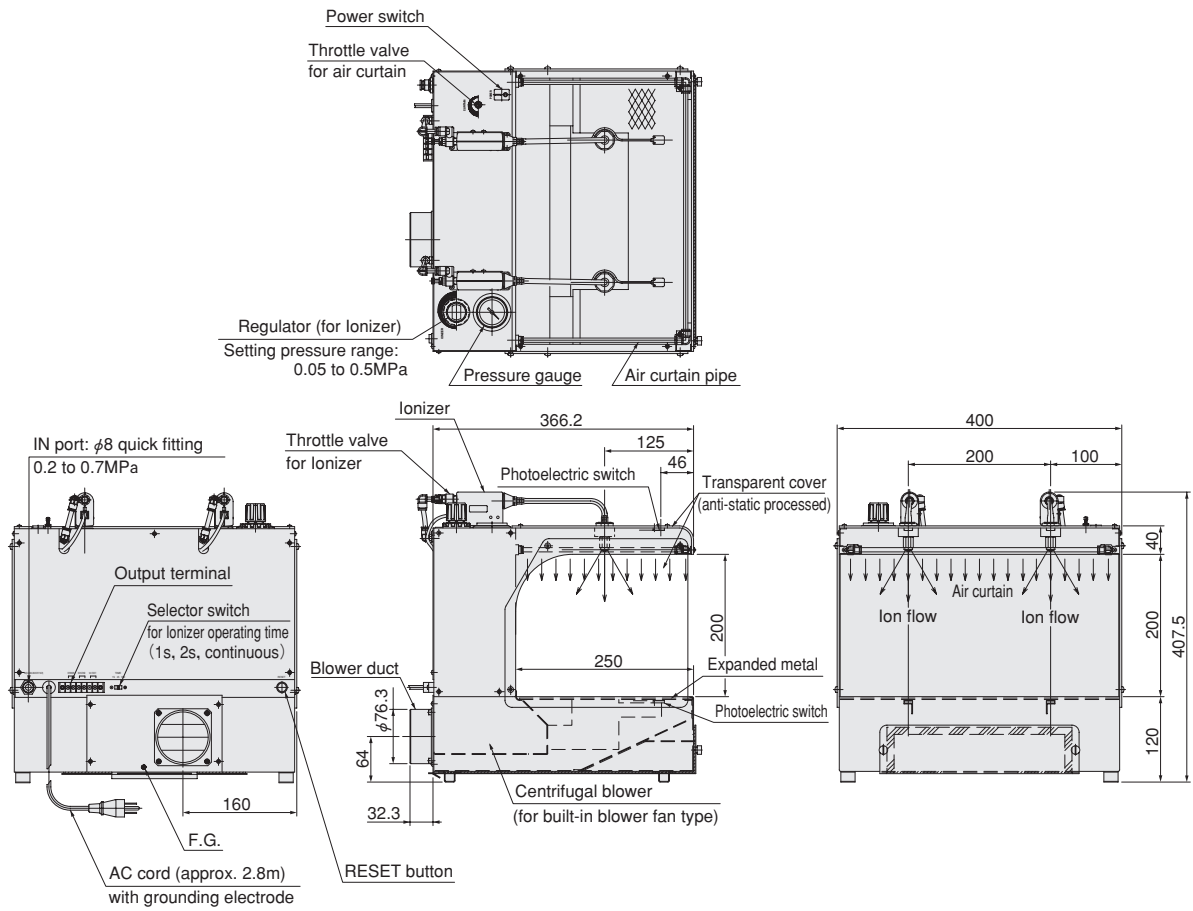

改訂履歴

History of Revisions

Ver.2.0 英文併記

Ver.2.0 Along with English translation

内容についてのご不明な点や技術的なご質問がございましたら、下記へお問い合わせください。

☐クレシード事業部 184-8533 東京都小金井市緑町3-11-28

クレシード専用フリーダイヤル  ^{ゴゴゴ クレシード} **0120-55-9040**

**JUST CONSULT US
KOGANEI CORPORATION**

OVERSEAS DEPARTMENT

3-11-28, Midoricho, Koganei City, Tokyo 184-8533, Japan

TEL : 042-383-7271 FAX : 042-383-7276

イオンワイパー

(エアカーテンダウンブロー形)

ION WIPER

(Air Curtain Down Blow Type)

DTY-WCM-S DTY-WC-S

DTY-WCM-L DTY-WC-L

取扱説明書

Owner's Manual

2005年3月 Ver.2.0 X903454

March 2005 Ver.2.0 X903454

©株式会社コガネイ クレシード事業部

©Koganei Corp. Creceed Division

本書の内容の一部もしくは、全てを無断で
複写・転写することを禁じます。

Any copy or reproduction of part or all of
the content of this manual is prohibited.



株式会社コガネイ

本社 〒101-0032 東京都千代田区岩本町3-8-16 東誠ビル
営業本部 〒184-8533 東京都小金井市緑町3-11-28

イオンワイパーに関するお問い合わせ先は…

クレシード事業部 184-8533 東京都小金井市緑町3-11-28

クレシード専用フリーダイヤル  **0120-55-9040**

URL <http://www.koganei.co.jp>