

Safety Precautions

This device is a precision electrical meter. For the sake of safety, be sure to follow the instructions described in this manual. ⚠ mark are precautions that must be followed in order to use the product safely.



Danger

This device does not conform to explosion-proof specifications. Do not install it in locations where flammable gases or solvents are handled, such as painting booths etc. Doing so may result in fire or explosion.



Caution

This device is a precision electrical meter. Avoid installing it in wet, oily, hot, and humid locations. In particular, avoid locations of high humidity and condensation. There is a possibility of fire due to breakdown.

Installation

- Do not use this device in the following locations, as doing so may cause malfunctions.
 - Locations subject to high or low temperature, or high humidity
 - Dusty locations
 - Locations where the device may be exposed to organic solvents such as thinner
 - Locations where the device may be exposed to corrosive gas
 - Locations subject to flames or explosions
 - Locations subject to frequent vibrations
 - Locations subject to sudden changes in temperature or humidity
 - Locations subject to condensation
 - Locations where the device may be exposed to water or oil

Maintenance

- Regularly remove any built-up dirt etc. from the optional monitor plate. Built-up dirt can cause insulation faults.
- Make sure to turn the main power of the device OFF before cleaning.

Handling

- Make sure to connect the grounding cable to an appropriate place. Accurate measurements are not possible if the earth wire is not connected.
- To obtain accurate measurements, measure at an appropriate distance from the charged object.
- Do not touch or insert foreign materials into the sensor portion of this device.
- Do not blow ionized air directly into the opening of this device.
- Do not place heavy objects on the liquid crystal display of this device.
- Do not disassemble or modify the device.
- The device may affect medical devices such as hearing aids or pacemakers.
- Do not insert any foreign objects into the device. Doing so may result in a short circuit or current leakage, and cause fire or electrocution.
- The battery discharges a small amount of electricity even when the device is turned off. If you do not intend to use this device for an extended length of time, remove the battery.
- If the device emits any abnormal odors or sounds, smoke, or heat, turn OFF the main power immediately, and contact your point of purchase. Failure to do so may result in fire or a short circuit.
- Do not remove name plates or labels.
- Do not do anything with the device that is not described in this manual.

Items Included With the Device

Confirm that the following items are included with the device before using it for the first time.

■ Instruction manual x 1 (this document)

■ Main Device

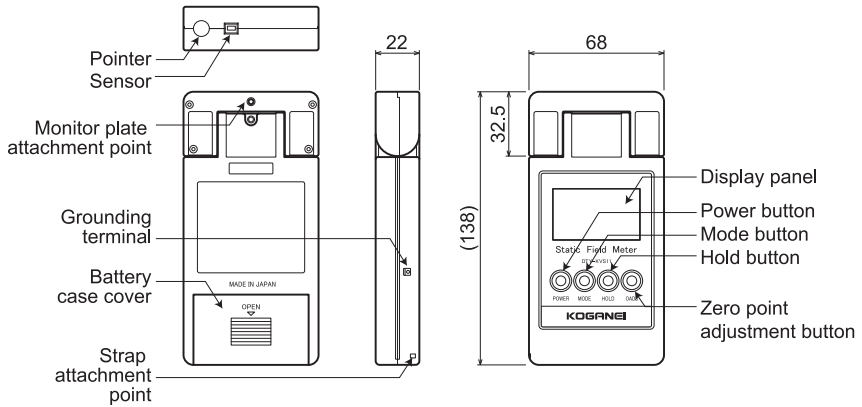

■ Grounding cable (x 1)

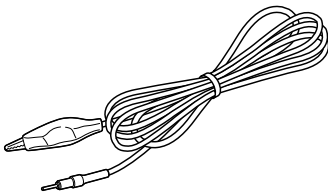

■ Strap (x 1)

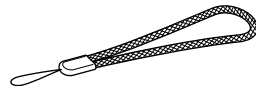

■ Battery (9V alkaline battery) x 1

■ Soft case x 1

■ Monitor plate (optional Model: DTY-ZMP-KVS11)

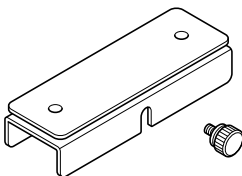

Specifications

Signal detection method	Oscillating chopper method
Display refresh frequency	0.5 seconds
Measurable potential range	Normal mode: 0.00 - ± 19.99 kV (resolution: 0.01kV)
	I.B mode: 0.000 - ± 1.999 kV (resolution: 0.001kV)
Continuous operating limit	Approximately 10 hours (with alkaline battery)
Measuring distance	30 mm (between object being measured and sensor)
Measuring distance adjustment	Red LED beam focusing method
Sensor head rotation angle	180° (stops every 45°, 5 directions)
Display	Liquid crystal display with built-in backlight
Polarity display	+ polarity/ - polarity display
Mode switching	Switch modes by pressing MODE button
Battery check	Remaining charge displayed in display panel
Power supply	9V alkaline battery
Operating temperature/ humidity range	0 - +40°C, 20 - 70%RH, non-condensing
Measurement accuracy	$\pm 10\%$ rdg ± 2 digit
Dimensions	68 mm x 22 mm x 138 mm (W x D x H)
Mass	Approximately 160g (including battery)

Important Points About Taking Measurements

Grounding

Ground the grounding terminal of this device to get performance according to specifications. Also, if the charged object is expected to have a large charge, be sure to ground the device to avoid breakdown due to discharge.

Adjusting the Measurement Distance

The strength of the electrical field of a charged object changes with the distance between the charged object and the sensor portion of the measuring meter. This device has been calibrated with a distance of 30mm between a test charged object (200mm x 200mm metal plate) and the meter. Consequently, when measuring it is necessary to conform to a measuring distance of 30mm. Move the meter so that the illuminated point on the charged object emitted by the pointer (red LED) is sharpest. If such a distance cannot be attained, correct the potential reading according to Figure 1.

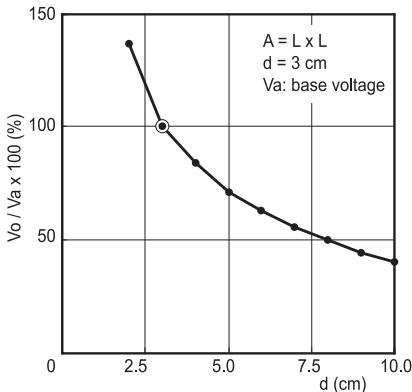

(Fig. 1) Relationship between measuring distance d and indicated value V_o of surface electrometer

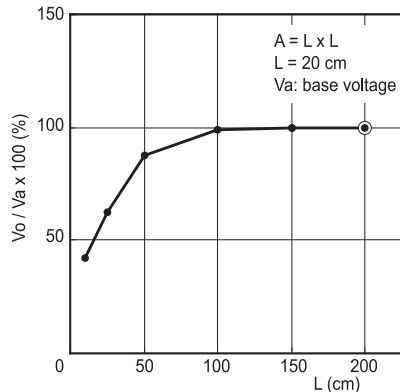

(Fig. 2) Relationship between size A (length L of one edge) of (square) charged object and indicated value V_o of surface electrometer

If the distance is more than the recommended measuring distance of 30mm, and the displayed potential exceeds 19.99kV, do not move the meter any closer to the charge object.



Caution

If the meter is too close to the charged body, there is the danger of an electrical discharge. This may cause a breakdown of the device.

Influence of the size of the charged object

The measured potential changes according to the field strength concentrated in the electrode of the sensor portion of the meter and the size of the charged object. In particular, if the charged object is smaller than the test charged object used during calibration (200mm x 200mm), there is a large discrepancy in the measured value and an error can occur in the resulting value. If this is the case, you can roughly correct the value according to Fig. 2.

Influence of other objects

If there are other objects near or behind the charged object, the displayed measurement is smaller than the actual potential. In this case, put as much distance as possible between the charged object being measured and other objects.

Influence of charged particles etc.

Highly charged objects impose a charge on particles and create an ionic space. If charged particles etc. adhere directly to the electrode of the meter, measurement errors will occur. This phenomenon occurs when a large amount of fluff adheres to the charged object or large amounts of dust are in the vicinity.

Preparation

1. Insert the battery.

Remove the battery case cover and insert a 9 V alkaline battery. Replace the cover carefully, taking care to keep the battery leads clear of the cover.

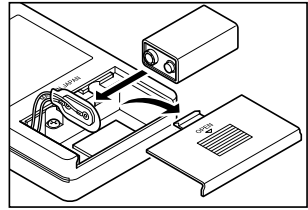

2. Connect the grounding cable to the grounding terminal, and reliably ground the grounding cable.

Connect the grounding cable securely to the terminal, and connect the clip on the end of the grounding cable to a grounded object. To obtain accurate measurements, the grounding terminal must be grounded.

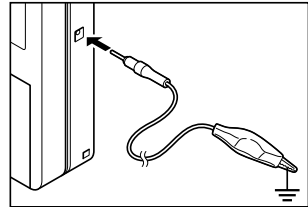

Measurement Procedure

Measuring Static Electricity

1. Turn the POWER button on.

Press the POWER button for more than one second, until you hear a beep.

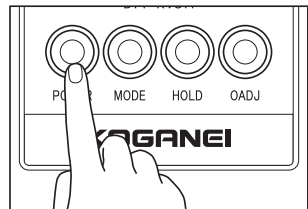

2. Set the mode you want to use.

Each time you press the MODE button, the meter scrolls through the modes in the order shown in the table on the right. To measure potentials, use the normal mode.

Mode	Panel display
Normal Mode	(None)
MAX Mode	MAX
I.B + MAX Mode	MAX I.B
I.B Mode	I.B

* The mode is set to the Normal mode when you turn on the meter.

3. Adjust the meter to zero point.

Point the sensor at a grounded object and press the OADJ button.

NOTE

- Zero point adjustment is reset when you turn the meter off.

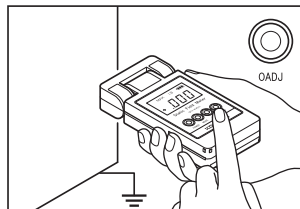

4. If you want to measure a maximum potential, use the MAX mode.

Refer to step 2 for how to set modes.

5. Point the sensor at the charged object, and gradually bring the meter closer to the object.

The distance between the sensor and the charged object should be 30mm. At about 30mm, the red LED beam (pointer) cast on the charged object should look like the image in Figure 3.

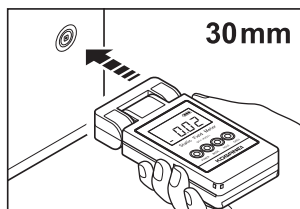

(Fig. 3) Red LED mark

NOTE

- If the recommended measuring distance of 30mm cannot be attained, do not bring the meter any closer if the potential displayed exceeds 19.99kV. Doing so may cause damage to the meter.
- If the display panel blinks "1", the charged voltage has exceeded the measurable range (over-range). If this occurs, stop measuring immediately, as this may cause damage to the meter.

6. The value on the display panel is the measurement result (unit: kV).

7. In normal mode, you can temporarily hold the measured value by pressing the HOLD button.

If you press the HOLD button again, the stored value is removed.

You cannot use the hold function in MAX mode.

8. To turn the meter off, press the POWER button for more than 1 second.

Measuring Ion Balance

By attaching the optional monitor plate (sold separately) to the meter, you can measure ion balance (offset voltage).

1. Turn the **POWER** button on.

Press the POWER button for more than one second, until you hear a beep.

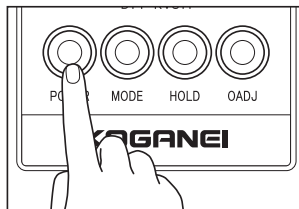

2. Set the mode you want to use.

Each time you press the MODE button, the meter scrolls through the modes in the order shown in the table on the right. To measure offset voltages, use the I.B. mode.

Mode	Panel display
Normal Mode	(None)
MAX Mode	MAX
I.B + MAX Mode	MAX I.B
I.B Mode	I.B

* The mode is set to the Normal mode when you turn on the meter.

3. Adjust the meter to zero point.

Point the sensor at a grounded object and press the OADJ button.

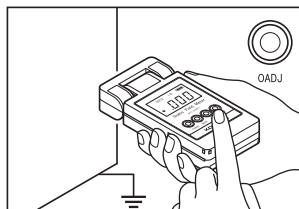

NOTE

- Zero point adjustment is reset when you turn the meter off.

4. Attach the monitor plate to the meter.

Firmly screw the monitor plate onto the meter with the screw provided, making sure that it is centered and there is no gap.

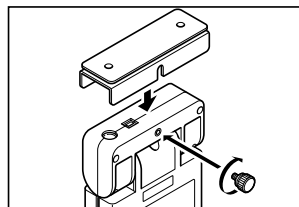

5. If you want to measure the maximum value of an offset voltage, use the **MAX I.B** mode.

Refer to step 2 for how to set modes.

6. Point the monitor plate at the measurement location.

The potential on the ion balance is measured.

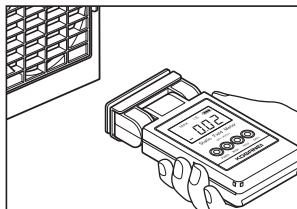

NOTE

- If the display panel blinks "1", the charged voltage has exceeded the measurable range (over-range). If this occurs, stop measuring immediately, as this may cause damage to the meter.

7. The value on the display panel is the measurement result (unit: kV).

8. In I.B mode, you can temporarily hold the measured value by pressing the HOLD button.

If you press the HOLD button again, the stored value is removed.

You cannot use the hold function in MAX I.B mode.

9. To turn the meter off, press the POWER button for more than 1 second.

Adjustment and Maintenance

Rotating the Sensor Head

You can rotate the sensor head of the meter. This enables you to easily take measurements in narrow locations etc. that were previously difficult to access.

The sensor head rotates in 45° increments (5 directions). When rotating the head, stop at angles where the sensor head clicks into place.

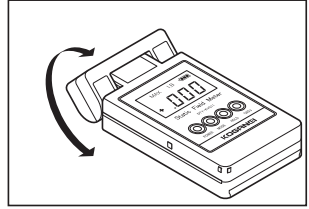

Battery Indicator

The remaining battery charge is displayed on the upper right of the display panel.

Replace the battery, because the meter has a bad influence continuing to use it when the battery charge icon shows one unit left.

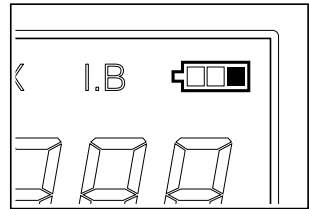

Error Display

The signal detection method of the meter is an oscillating chopper method.

If for some reason the sensor stop oscillating, an error message like that shown in the illustration on the right is displayed, and the meter emits a beeping sound every second.

If this occurs, restart the meter. If the error message continues to be displayed, the sensor may be faulty. In this case, immediately turn off the power from the product, and please contact the outlet (the agency) at which you purchased the product, or the nearest Koganei service station.

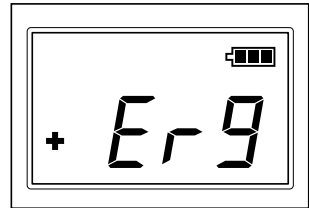

Troubleshooting

If the device does not operate correctly, it may be the result of one of the following.

The display panel is not active when the power is turned on.

Cause 1	The battery has not been installed, or the positive and negative terminals have been connected the wrong way around.
Remedy 1	Correctly install the battery.
Cause 2	The battery has been completely drained.
Remedy 2	Replace the battery with a new one.

The display panel displays correctly, but does not zero.

Cause 1	Zero point adjustment is incorrect.
Remedy 1	Perform zero point adjustment again.
Cause 2	Structural components close to the sensor are charged.
Remedy 2	Wait until the charge in the components has attenuated.

The display does not change even when approaching a charge object.

Cause 1	The meter is holding a maximum value in MAX mode or MAX I.B mode.
Remedy 1	Press the MODE button to switch modes.
Cause 2	The meter is holding a measured value in normal mode or I.B mode.
Remedy 2	Press the HOLD button and start measuring again.
Cause 3	The sensor is faulty.
Remedy 3	If an error message is displayed or you cannot hear an oscillating sound from the sensor, the sensor must be replaced. In this case, immediately turn off the power from the product, and please contact the outlet (the agency) at which you purchased the product, or the nearest Koganei service station.



KOGANEI CORPORATION

JUST CONSULT US:

KOGANEI CORPORATION OVERSEAS DEPARTMENT
3-11-28, Midoricho, Koganei-shi, Tokyo, 184-8533, Japan
TEL:+81- 042-383-7271 FAX:+81- 042-383-7276

Website: <http://www.koganei.co.jp>

The specifications or the appearance of this product are subject to change any time without prior notice.

